



BALLINA SHIRE COUNCIL

**ATTACHMENTS TO
LOCAL TRAFFIC COMMITTEE
MEETING BUSINESS PAPER**

EXCLUDED FROM AGENDA

Wednesday 10 June 2020

Table of Contents

7.1	Proposed Signalisation - Brunswick Street/River Street Intersection, Ballina Attachment : Brunswick Street/River Street, Ballina - Traffic Signal Warrants Study	1
7.2	Byron Bay Road/Byron Street Intersection, Lennox Head Attachment 1: Byron Bay Road/Byron Street Intersection - Road Safety Audit	51
	Attachment 2: Byron Bay Road/Byron Street, Lennox Head - Safe Systems Assessment.....	73
7.4	Traffic Issues, Hill Street/Pine Avenue/The Coast Road, East Ballina (Section A) – Road Safety Audit Attachment 1: Road Safety Audit Section A - Hill St, Pine Ave, The Coast Rd.....	94
	Attachment 2: Safe Systems Assessment Section A - Hill St, Pine Ave, The Coast Rd.....	135
7.5	Traffic Issues, Hill Street/Brighton Street/Range Street/Shaws Bay Hotel and Caravan Park Entrances Area (Section B) - Road Safety Audit Attachment 1: Road Safety Audit Section B - Hill St, Brighton St, Range St, Hotel/Caravan Park Entrances/Informal Parking Areas....	149
	Attachment 2: Safe Systems Assessment Section B - Hill St, Brighton St, Range St, Hotel/Caravan Park Entrances, Informal Parking Areas	195

DISCLAIMER ©NSW Spatial Services 2017. Although all care is taken in the preparation of plans within Council’s business paper (both agendas and attachments), Ballina Shire Council accepts no responsibility for any misprints, error, omissions or inaccuracies. The information contained within each plan is for pictorial representation only and not to scale. Accurate measurements should be undertaken by survey.

Issue History

File Name	Prepared	Reviewed	Issued by	Date	Issued to
P4541.001T Ballina Traffic Signal Warrants Study Technical Note	C. Mak	A. Ahmed	M. Hearne	26/05/2020	Patrick Knight <Patrick.Knight@ballina.nsw.gov.au>

River Street & Brunswick Street, Ballina

Traffic Signal Warrants Study

1. Introduction

1.1 Background

Ballina Shire Council has commissioned Bitzios Consulting to undertake a traffic study to investigate if the Transport for NSW (formerly Roads and Maritime Services) signalised intersection warrants are met at Brunswick Street and River Street intersection.

This technical note summarises the findings of the warrant assessment process, including justifications for the inclusion of traffic signals at the subject intersection to better facilitate right turns and pedestrian movements. It includes the findings of SIDRA modelling analysis of the subject intersection, investigating the impacts on the performance of general traffic at the subject intersection.

1.2 Subject Intersection

The subject intersection is shown in Figure 1.1.



Figure 1.1: River Street & Brunswick Street Intersection

The area north of River Street at the vicinity of Brunswick Street will be known as “Area North” in this technical note, and the area south of River Street will be known as “Area South”.



**River Street & Brunswick Street, Ballina: Traffic
Signal Warrants Study**
Project: P4541 Version: 001

1.3 Surrounding Road Network

1.3.1 River Street

River Street is the main east-west thoroughfare between Pacific Motorway in the west and the Ballina Town Centre in the east. North Creek Canal is located around 350 metres west of the subject intersection, with River Street crossing the canal with a bridge ("Bridge").

It has a posted speed limit of 60 km/h. At the subject intersection, it has 2 lanes in the eastbound direction and 1 lane in the westbound direction, with turning lanes for right turning movements from River Street to Brunswick Street. A turn lane is also provided for left turning movements from River Street eastbound to Brunswick Street north.

There are three (3) other intersections along River Street within 500 metres of the subject intersection. Two of the three are intersections with Bagot Street and Tweed Street. Bagot Street is a left-out only intersection and Tweed Street is a left-in-left-out intersection.

The third intersection is the signalised intersection of River Street and Kerr Street.

1.3.2 Brunswick Street

Brunswick Street is a short local north-south road, with one lane in each direction. It has a posted speed limit of 50 km/h. The southern end of Brunswick Street is Riverview Park, which has a picnic area and a boat ramp.

It is understood that vehicles have to wait for a long time to perform a right turn from Brunswick Street north to River Street westbound, and a large number of them will perform left turning movements and take a longer detour route through the network to complete a quasi-right turn. Some of the possible detour routes are outlined in Table 3.4.

1.4 Traffic Signal Warrants

In order for an intersection to be upgraded to a signalised intersection, it generally needs to meet traffic signal warrants, which are outlined in Transport for NSW's *Traffic Signal Design – Section 2 Warrants*.

The warrant that is most relevant for the subject intersection is as follows:

- *For each of four one-hour periods of an average day:*
 - (i) *The major road flow exceeds 900 vehicles/hour in each direction*
 - (ii) *The minor road exceeds 100 vehicles/hour in one direction*
 - (iii) *The speed of traffic on the major road or limited sight distance from the minor road causes undue delay or hazard to the minor road vehicles; and*
 - (iv) *There is no other nearby traffic signal site easily accessible to the minor road vehicles*

An assessment of the warrants is detailed in Section 5.



2. Historical Information

2.1 Ballina Bypass

River Street was formerly part of the Pacific Highway route between Sydney and Brisbane until 2012 when the Ballina Bypass was completed. Significant numbers of heavy vehicle movements were shifted from the roads of Ballina onto the new alignment of Pacific Highway/Pacific Motorway.

2.2 Development History

In 2016, a median divide was installed along River Street. As such, Tweed Street, located east of the subject intersection, was restricted to left turns only. All direct right turns from Area North to River Street now must occur at the Brunswick Street intersection.

In 2019, a service station began operations on the north-west corner of the subject intersection and attracts high activity based on site visit observations. The petrol station was required to install an extended eastbound lane on River Street. Signalisation of the subject intersection may induce rat-running via the service station for left turning vehicles due to the extra waiting time.

3. Existing Conditions

3.1 Site Visit

A site visit was undertaken in the morning of 11 March 2020,. The following observations were made:

- High traffic volumes on River Street and generally few safe gaps in traffic for right turns
- Minimum waiting time of around 30 seconds for a few vehicles that turned right from Brunswick Street north
- No vehicles turning right from Brunswick Street south
- Westbound traffic was slightly platooned from Kerr Street lights (comes in waves). There was no platooning of eastbound traffic
- High activity at the petrol station on north-west corner
- Pedestrian refuge on River Street to the east, however pedestrians were observed crossing midblock and not at refuge or the intersection
- Generally low pedestrian and cyclist volumes
- Elderly pedestrians and mobility scooters in the area
- Refuge crossing across Brunswick Street north is not wide enough for mobility scooters, bikes, etc.
- River Street is noted to have steep crossfall
- There are no kerbs along Brunswick Street south; instead it has informal grassed verges

3.2 Pedestrian Safety

The nearest controlled crossing to the subject intersection across River Street is the signalised intersection at Kerr Street, located 450 metres east of the subject intersection. However, there is no signalised crossing on the western approach of the intersection. To access between Area North and Area South, three signalised crossings have to be crossed: one across Kerr Street (north) to the eastern side, one across River Street (east) and one across Kerr Street (south) back to the western side.



Alternatively, pedestrians may utilise the pedestrian refuge east of River Street. However, this may not be as safe as pedestrians have to cross three lanes of high-volume 60 km/h traffic. It was observed during the site visit that there are no adequate gaps in traffic for the refuge to be used. It was also observed that pedestrians were not utilising the pedestrian refuge, but instead crossed at other locations of the median divide.

3.3 Crash History

From Transport for NSW's Centre for Road Safety website, for the five-year period between 2014 and 2018, there were nine (9) crashes along River Street within 400 metres of the subject intersection. In particular, there was a crash at the subject intersection resulting in a moderate injury, as shown in Figure 3.1. Most of the crashes along River Street are prior to 2016, when the median divide was installed.

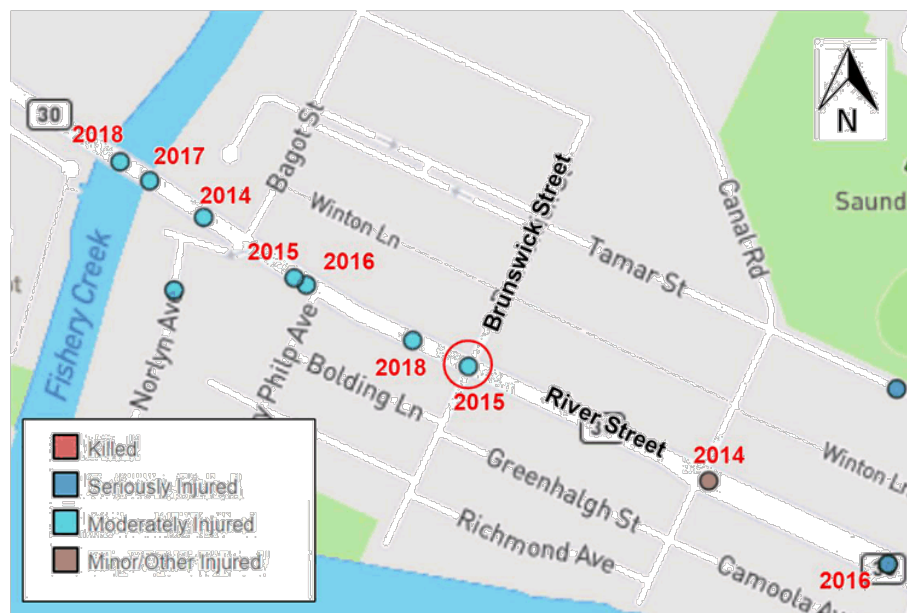

Source: Transport for NSW – Centre for Road Safety

Figure 3.1: Crashes Surrounding the Subject Intersection

3.4 Intersection Counts

Intersection count surveys for the subject intersection were undertaken on Thursday 19 March 2020, between 07:00 to 10:00 and 14:30 to 17:30. OD surveys were also undertaken on the same day (see Section 3.5). The peak hours identified are:

- AM Peak: 08:00-09:00 AM
- PM Peak: 15:15-16:15 PM.

The Brunswick Street northern approach/exit has approach and exit volumes of around 42 and 82 in the AM peak, and 57 and 96 in the PM peak. The Brunswick Street southern approach/exit has approach and exit volumes of 11 and 13 in the AM peak, and 11 and 27 in the PM peak. River Street has volumes of 1000 to 1500 in each direction in all peaks.

Assessment of traffic volumes against the traffic signals warrant is detailed in Section 5.



The turning counts of the intersection are shown in Figure 3.2. They are also shown in Attachment A.

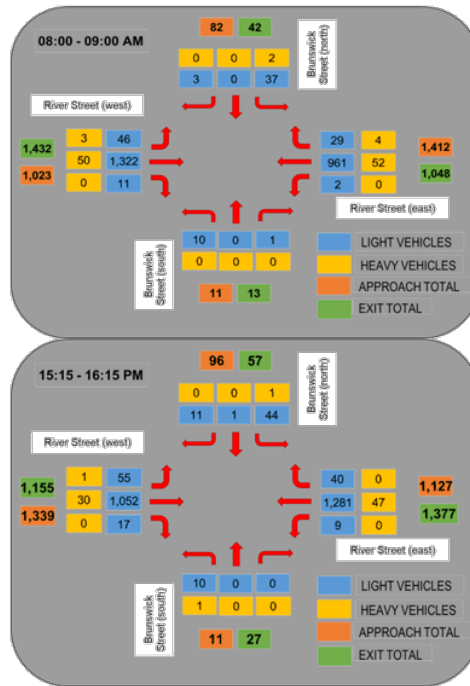

Figure 3.2: Existing Turning Counts at River Street / Brunswick Street

3.5 Origin-Destination Surveys

3.5.1 Survey Locations

Origin-Destination (OD) surveys were undertaken on 19 March 2020, Thursday, the same day as the intersection count surveys, between 07:00 to 10:00 and 14:30 to 17:30. The surveys were undertaken at six (6) locations for either one-way or two-way traffic, and as origin and/or destination. The locations and the directions surveyed are shown in Table 3.1 and Figure 3.3.

Table 3.1: OD Survey Locations

OD Number	Direction	Road	Location
1	Eastbound	River Street	at Bridge
	Westbound	River Street	at Bridge
2	Westbound	Canal Road	west of Bagot Street
3	Eastbound	River Street	between Tweed St and Kerr St
4	Eastbound	Camoola Avenue	west of Kerr Street
	Westbound	Camoola Avenue	west of Kerr Street
5	Eastbound	Tamar Street	between Tweed St and Kerr St
6	Eastbound	River Street	between Tweed St and Brunswick St





Source: OpenStreet Map

Figure 3.3: OD Survey Locations

3.5.2 Data Limitations

Survey location 3 had no survey data in the PM peak due to the damaged cameras as a result of vandalism. As such, PM survey data for location 3 was estimated from the nearby survey location 6.

Additionally, due to survey location 2 recorded as a destination only, the demand from Area North to River Street westbound via Canal Road (detour route 6) cannot be determined. Considering the length of route 6 compared to the other detour routes, the utilisation of this route is likely to be low anyway.

3.5.3 OD Volumes

OD survey data relevant to the demand from Area North to River Street westbound, as according to Section 1.1, are the following:

- 3 EB to 1 WB
- 6 EB to 1 WB
- 5 EB to 1 WB
- 3 EB to 4 WB
- 6 EB to 4 WB.

OD survey data relevant to the demand from Area South to Kerr Street or River Street eastbound are:

- 4 EB Origin Total

OD survey data relevant to determining entry and exit volumes of River Street eastbound are:

- 1 EB to 6 EB
- 1 EB to 3 EB
- 6 EB to 3 EB.



The volumes of these data for the peak hours are shown in Table 3.2.

Table 3.2: OD Survey Data

O-D	Detour Route	0800-0900	1515-1615
Area North to River Street westbound			
3 EB to 1 WB	Routes 1 to 5	50	38*
5 EB to 1 WB	Routes 4 & 5	3	5
6 EB to 1 WB	Routes 1 to 5	47	30
3 EB to 4 WB	Route 3	5	4*
6 EB to 4 WB	Route 3	0	0
Area South to Kerr Street or River Street eastbound			
4 EB (all)	-	39	47
River Street eastbound OD Volumes			
1 EB to 6 EB	N/A	1,016	776
1 EB to 3 EB	N/A	937	798*
6 EB to 3 EB	N/A	1,045	716*

*Estimated from survey location 6 due to insufficient data at survey location 3

The volumes for Area North to River Street westbound via Camoola Street (detour route 3) would have already been covered by both 3 EB to 1 WB, 6 EB to 1 WB, and so the volumes for 3 EB to 4 WB and 6 EB to 4 WB were not included in trip redistribution calculation in Section 3.8.1 to avoid double-counting.

3.6 COVID-19 Pandemic

As the traffic surveys were undertaken in late March 2020 in the midst of the COVID-19 pandemic, traffic volumes recorded may not accurately represent usual traffic volumes before the pandemic.

Tube counts were undertaken in 2019 and were provided as part of the study brief for this project. A comparison between the 2019 tube counts and 2020 intersection counts is shown in Table 3.3.

Table 3.3: 2019 Tube Counts vs 2020 Traffic Surveys

Approach/Exit	0800-0900 (Weekday)		1500-1600 or 1515-1615 (Weekday)	
	2019 Tube	2020 Intersection	2019	2020
Northern Exit	74	82	87	96
Northern Approach	39	42	46	57
Eastern Exit	-	1412	-	1128
Eastern Approach	1259	1048	1192	1378
Southern Exit	17	13	25	27
Southern Approach	8	11	14	11
Western Exit	1065	1030	1358	1352
Western Approach	-	1436	-	1157

It is important to note that in the tube counts, the peak hour volumes for Brunswick Street occur outside of the typical peak hours, with AM being around 10:00 AM or 11:00 AM and



PM being around 19:00 PM or 20:00 PM. These periods are outside the surveyed hours for the 2020 traffic surveys.

With the exception of eastern approach, all other approaches and exits have roughly similar volumes between the 2020 traffic surveys and the 2019 tube counts. The eastern approach has substantially different volumes of about 200 between both surveys, with 2020 surveys having lower volumes in the AM peak and higher volumes in the PM peak.

As such, the volumes in the 2020 survey are deemed acceptable and need no adjustments.

3.7 Detour Routes

3.7.1 Routes from Area North to River Street westbound

The right turn from Brunswick Street north to River Street westbound is the most direct route. Right turns are not permitted at Bagot Street, Tweed Street and Tamar Street, as shown in Figure 3.4, due to the median divide along River Street and Kerr Street.



Source: OpenStreet Map

Figure 3.4: Inaccessible Routes from Area North to River Street westbound

Other routes to achieve a westbound movement from Area North are detailed in Table 3.4. The approximate length for each detour route was defined as starting from the subject intersection eastbound or northbound, and ending at the Bridge westbound.

Table 3.4: Routes from Area North to River Street westbound

Route	Route Description	Approximate Length (metres)
Detour Route 1	River Street EB, U-turn at Grant Street roundabout, River Street WB	1750
Detour Route 2	River Street EB, right into Kerr Street SB, 3-point turn, Kerr Street NB, left into River Street WB	1350



Route	Route Description	Approximate Length (metres)
Detour Route 3	River Street EB, right into Kerr Street SB, right into Camoola Avenue, right into Tweed Street (south), left into River Street WB	1350
Detour Route 4	Tamar Street or River Street EB, Kerr Street NB, right into Crane Street EB, right into Grant Street SB, right into River Street WB	2300
Detour Route 5	Tamar Street or River Street EB, Kerr Street NB, right into Crane Street EB, 3-point turn, Crane Street WB, left into Kerr Street SB, right into River Street WB	2050
Detour Route 6	Canal Road NB, right into Fox Street EB, right into Kerr Street SB, right into River Street WB	3900
Direct Route	Direct right turn from Brunswick Street EB into River Street WB	N/A

These detour routes, shown in Figure 3.5 and Figure 3.6, are fairly and highly circuitous. Routes 1, 2 and 3 are the least circuitous and most straightforward. However, it is not possible to determine which of the routes are the most used as there are no OD survey locations along River Street east of Kerr Street, or Kerr Street south of River Street.

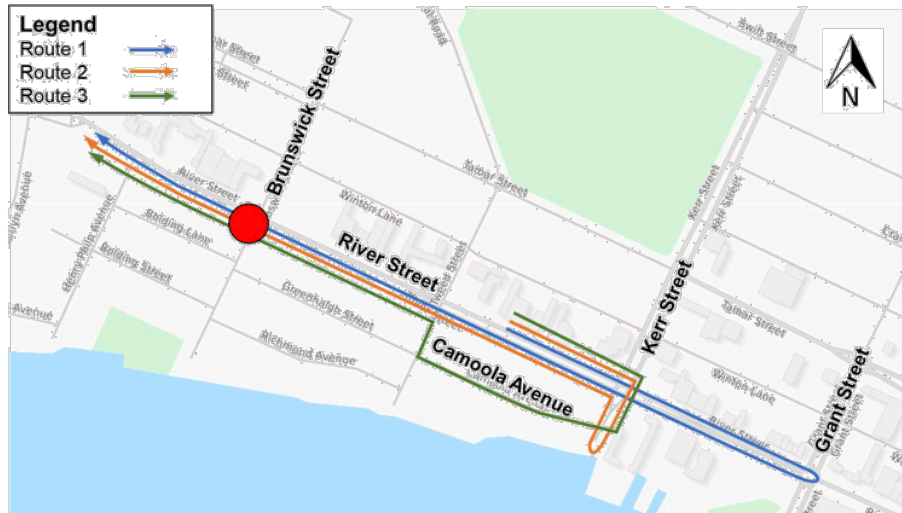

Source: OpenStreet Map

Figure 3.5: Possible Detour Routes 1 to 3



River Street & Brunswick Street, Ballina:
 Traffic Signal Warrants Study
 Project: P4541 Version: 001

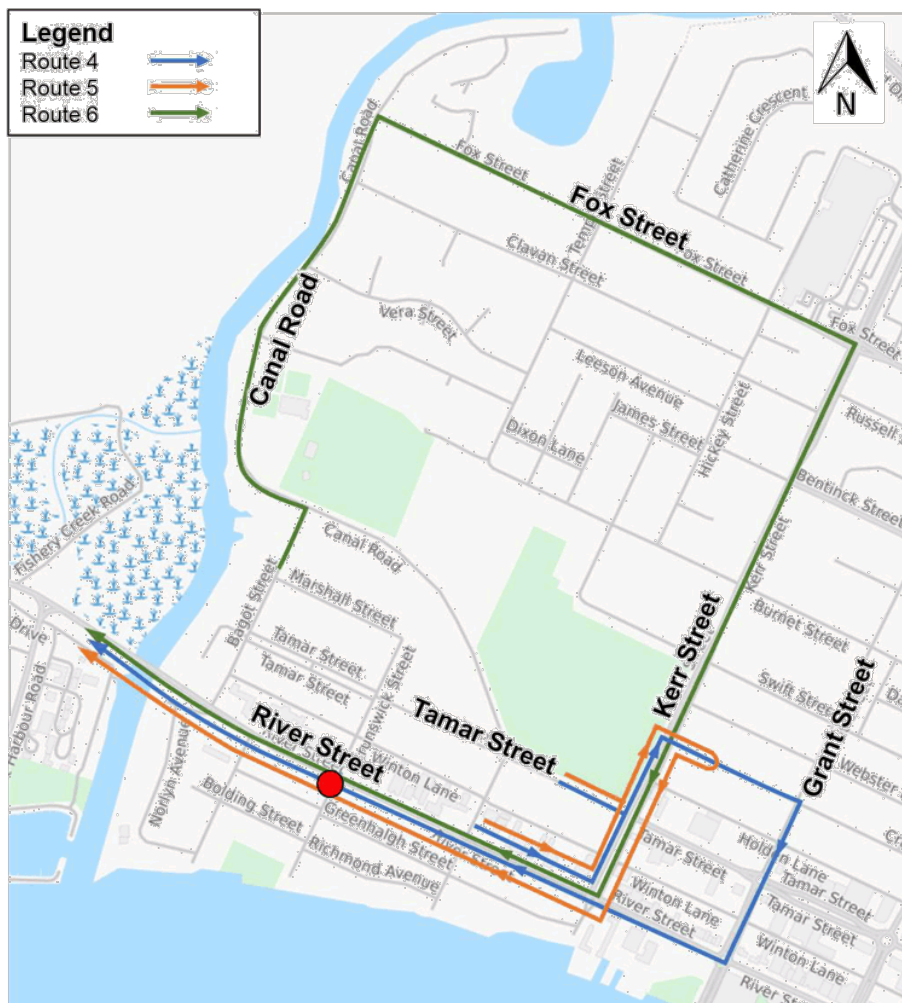

Source: OpenStreet Map

Figure 3.6: Possible Detour Routes 4 to 6

3.7.2 Routes from Area South to Kerr Street or River Street eastbound

From Area South, the most direct route to get to Kerr Street will be the right turn from Brunswick Street south to River Street eastbound. The only other route to achieve a northbound and eastbound movement from Area South is via Greenhaigh Street, Camoola Avenue and then Kerr Street northbound, shown in Figure 3.7.

While both routes are similar in length, Greenhaigh Street and Camoola Avenue are local narrow roads, which are not ideal as a main traffic route.



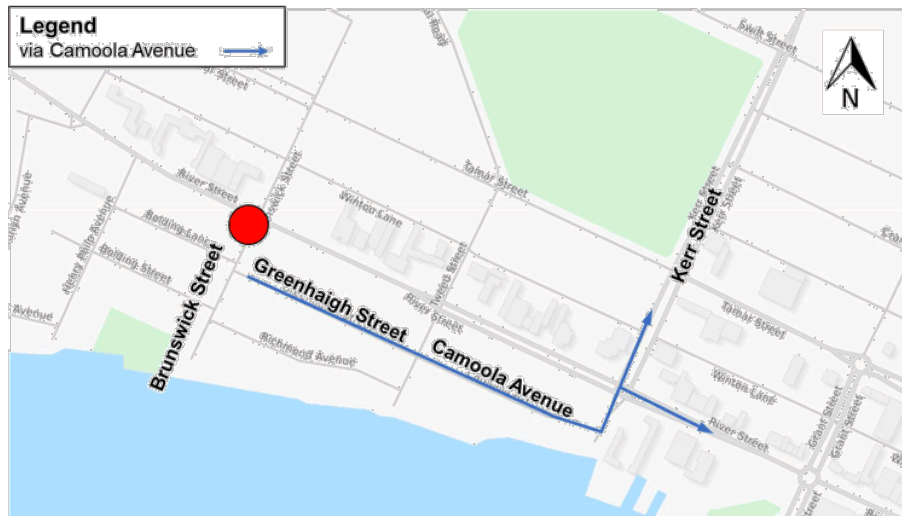

Source: OpenStreet Map

Figure 3.7: Area South to Kerr Street via Camoola Avenue

3.8 Existing Demands

With both intersection counts and OD data, the existing demands from Area North to River Street westbound and Area South to Kerr Street can be determined. Figure 3.8 and Figure 3.9 shows the movements and routes around the area and their deduced volumes in the AM and PM peak respectively, based on the intersection counts and OD surveys.



River Street & Brunswick Street, Ballina:
 Traffic Signal Warrants Study
 Project: P4541 Version: 001

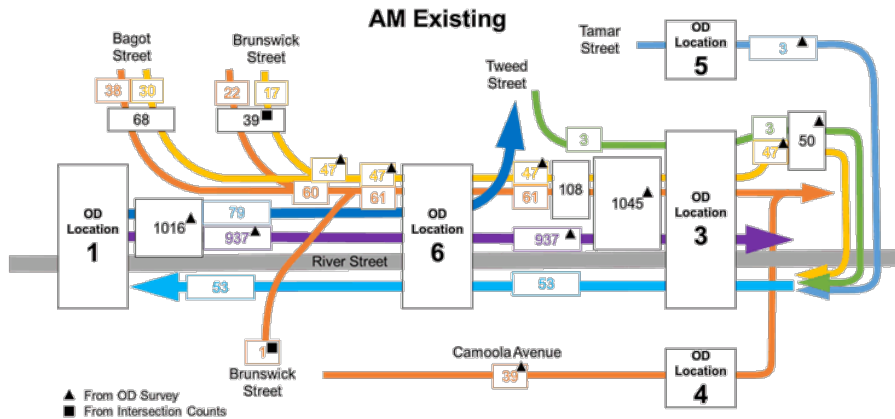

Figure 3.8: Deduced Traffic Volumes – AM Peak

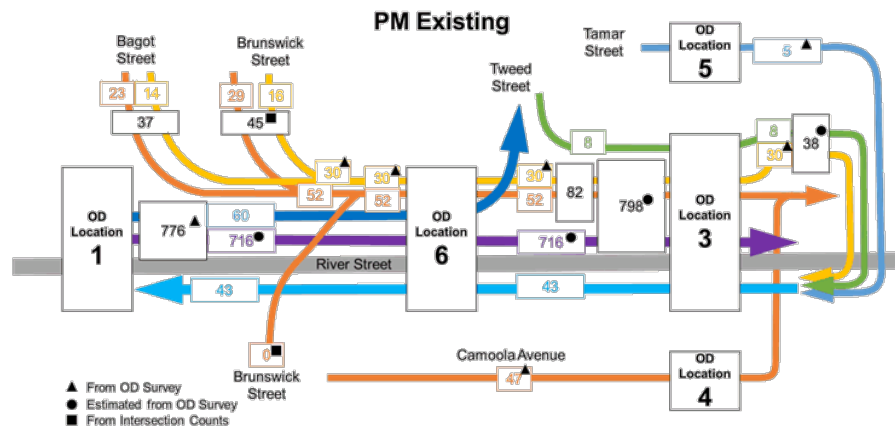

Figure 3.9: Deduced Traffic Volumes – PM Peak

From Figure 3.8 and Figure 3.9, it was deduced that 53 vehicles and 43 vehicles travel via various detour routes between Area North to River Street WB in the AM and PM peak respectively. OD survey time data confirms that these vehicles take at least 3 or 4 minutes on average to get from Area North to River Street WB at the North Creek Canal Bridge, suggesting that detour routes were used. However, as mentioned in Section 1.1, the exact proportions of volumes using each detour route cannot be determined due to the lack of OD survey data east of Kerr Street.

Similarly, it was deduced that 39 and 47 vehicles travel via Camoola Avenue between Area South to Kerr Street or River Street EB in the AM and PM peak respectively.

Currently, the right turn from Brunswick Street to River Street WB is very low. However, these are very likely to be artificially low as the OD survey shows that there are existing demands from Area North to River Street WB. The demands will be redistributed to the right turn from Brunswick Street to River Street WB if the intersection is signalised.

3.8.1 Traffic Redistribution

The traffic demand from Area North to River Street west was redistributed to a signalised River Street / Brunswick Street intersection, where it is easier to turn right from Brunswick



Street north to River Street westbound. The redistributed traffic volumes in AM and PM peaks are shown in Figure 3.10 and Figure 3.12 respectively, and the intersection counts of the subject intersection with the redistributed traffic are shown in Figure 3.11 and Figure 3.13 respectively.

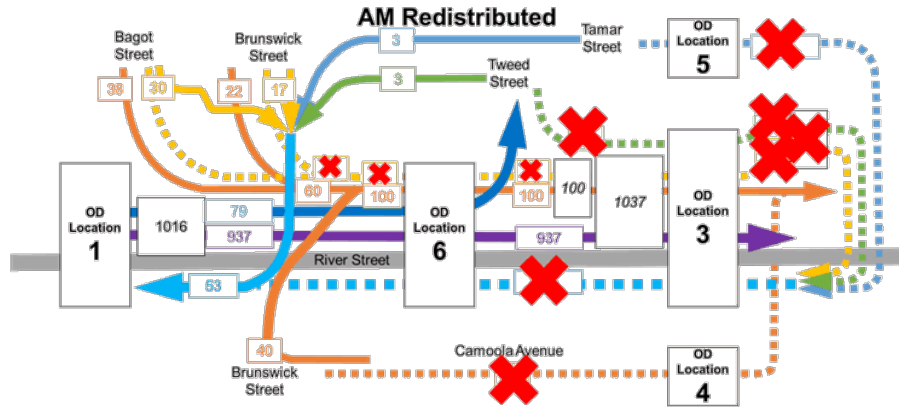

Figure 3.10: Redistributed Traffic Volumes along River Street – AM Peak

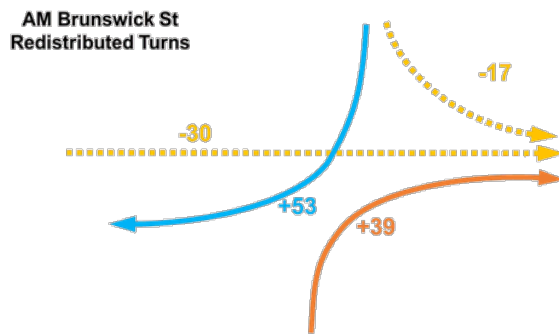

Figure 3.11: Intersection Counts with Redistributed Traffic – AM Peak



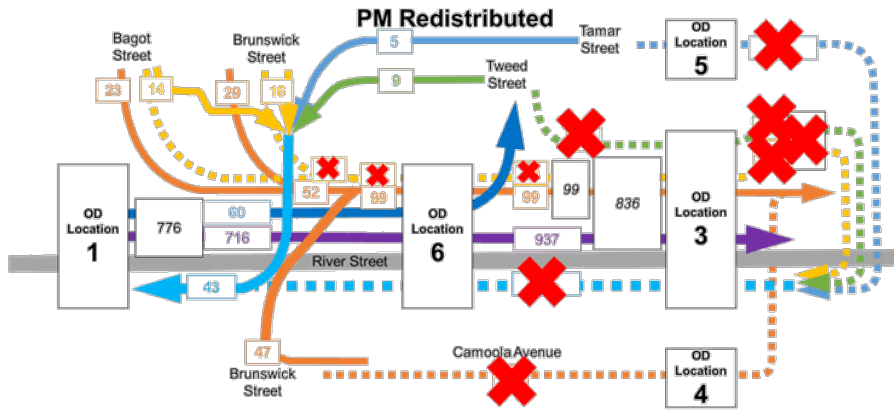

Figure 3.12: Redistributed Traffic Volumes along River Street – PM Peak

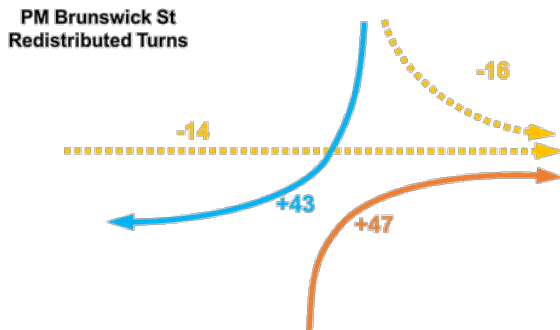

Figure 3.13: Intersection Counts with Redistributed Traffic – PM Peak

The turning counts of the intersection with the redistributed traffic volumes are shown in Figure 3.2. They are also shown in **Attachment A**.

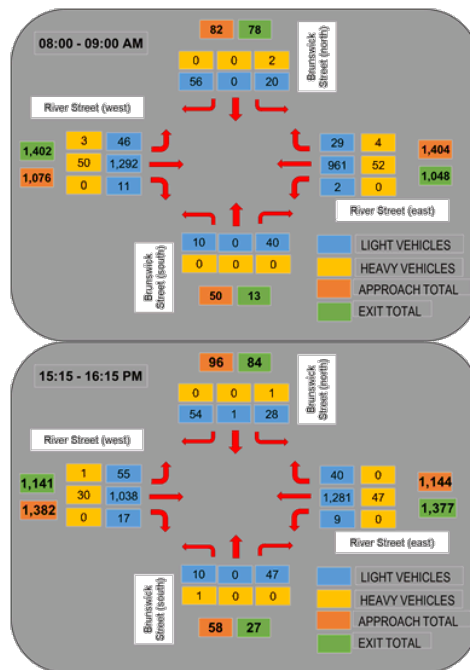

Figure 3.14: Turning Counts with Redistributed Traffic

Even with redistributed traffic volumes, the northern approach will see an increase to 78 and 84 vehicles in the AM and PM peak respectively, while the southern approach will see an increase to 50 and 58 vehicles respectively. The new volumes still do not meet the required minor road warrant volumes of 100. However, traffic volumes may increase due to population growth at Ballina.

3.8.2 Savings in Vehicle Kilometres Travelled

It is assumed detour route 1 (u-turning at Grant Street) is the most used route due to it being one of the shortest and most straightforward route. The distance between Brunswick Street and the Grant Street roundabout is 700 metres, therefore for a two-way travel, this distance comes to 1.4 kilometres. This is also the distance saved if vehicles turn right from Brunswick Street north to River Street westbound instead of utilising the detour routes.

For the AM peak, 53 vehicles were redistributed to the right turn. Hence, the VKT saving for the AM peak is 74.2 km. For the PM peak, 43 vehicles were redistributed to the right turn. Hence, the VKT saving for the PM peak is 60.2 km. These savings are minimum savings as they are based on the most direct detour route and does not take into account the other circuitous detour routes.

3.9 SIDRA Base Model Analysis

SIDRA 8.0 models were prepared for the base scenario (Scenario 1), with the existing intersection layout and existing (2020) intersection counts.

The models were prepared for the subject intersection for the AM and PM peak periods:

- AM Peak: 08:00 to 09:00
- PM Peak: 15:15 to 16:15.



3.9.1 Base Model SIDRA Inputs

The inputs of the base models were:

- 'Current Setup' was set to New South Wales
- Site Level of Service Method was set to 'Delay (RTA)'
- Physical features of the intersection geometries were determined using Nearmap aerial imagery
- Turning volumes as determined from traffic surveys in Section 3.4 were used
- Default values for Basic Saturation Flow were used
- Speed limits were input as per existing posted speed limits at each site.
- The gap acceptances of all turns are the default setting with the exception of:
 - The right turn from River Street eastbound to Brunswick Street south: 4 seconds critical gap and 2 seconds follow-up headway
 - Through movements along Brunswick Street: 6 seconds critical gap and 3 seconds follow-up headway

3.9.2 Traffic Volume Limitations

Some of the existing turns have zero (0) existing volumes. However, the SIDRA software does not allow inputs of zero (0) volumes. Therefore, the corresponding movements were removed from the SIDRA models to avoid erroneous results as much as possible.

3.9.3 Geometrical Layouts

The SIDRA geometrical layout, shown in Figure 3.15, was based on the latest aerial images and site visit observations. The layout for scenario 2 in Section 4 will also be identical. It is important to note that some turning movements from Brunswick Street approaches have been omitted as outlined in Section 3.9.2.

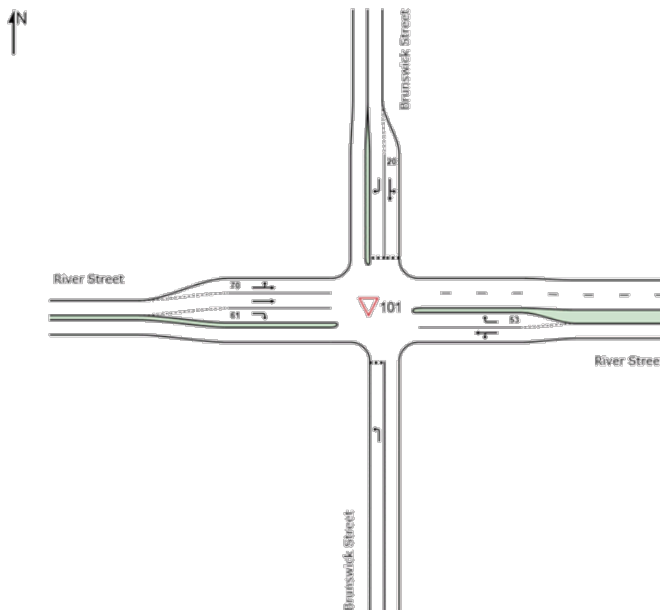

Figure 3.15: SIDRA Geometrical Layout – Scenario 1 (Base)



River Street & Brunswick Street, Ballina:
 Traffic Signal Warrants Study
 Project: P4541 Version: 001

3.9.4 Intersection Performance

The intersection performance of Scenario 1 (base) for AM and PM peaks are shown in Table 3.5 and Table 3.6 respectively. SIDRA movement summary results are shown in Attachment C.

Table 3.5: Scenario 1 Intersection Performance - AM Peak

Approach	DOS	Average Delay (s)	LoS	95 th Percentile Queue (m)
Brunswick Street (north)	1.00	128	LOS F	17
River Street (east)	0.57	1	N/A	6
Brunswick Street (south)	1.00	407	LOS F	16
River Street (west)	0.39	0	N/A	1
Overall	1.00	5	N/A	17

Table 3.6: Scenario 1 Intersection Performance - PM Peak

Approach	DOS	Average Delay (s)	LoS	95 th Percentile Queue (m)
Brunswick Street (north)	1.93	492	LOS F	52
River Street (east)	0.74	1	N/A	3
Brunswick Street (south)	0.20	63	LOS E	4
River Street (west)	0.32	1	N/A	2
Overall	1.93	12	N/A	52

Under existing conditions in the current year, Brunswick Street approaches have levels of service E or F in the AM and PM peaks. As the intersection is not signalised, the intersection does not have a level of service.

The Brunswick Street north approach has an average delay of more than 100 seconds in both AM and PM peaks. Similarly, the Brunswick Street south approach also has long average delays in the AM peak. The long delays at both approaches correspond with the long waiting times observed during the site visit.



4. **SIDRA Options Analysis**

4.1 **Future Traffic Demands**

From Forecast ID, which is based on past Census Data, Ballina is forecasted to have a population growth of 9% between 2020 and 2030. The 9% growth is also applied as traffic growth on all intersection counts including existing (Section 3.4) and redistributed (Section 3.8.1) volumes, which will be used as 2030 volumes. The future intersection turning counts are shown in **Attachment A**.

4.2 **Proposed Intersection Layout**

There are plans to upgrade River Street to four lanes in the near future, including the duplication of the Bridge in the west. This is to occur before the Tamarind Drive duplication (at the north) and well before the Western Arterial Road (new north-south link immediately west of the Bridge), both of which are road projects proposed by Council.

The concept plan showing the proposed layout of the subject intersection is shown in **Attachment B**. In the proposed layout, an additional westbound lane of River Street will be added to the eastern approach and western exit, and a dedicated left turn lane is added to the western approach. Brunswick Street will also have two lanes in each approach.

4.3 **Scenarios**

In addition to the 2020 base model (Scenario 1), SIDRA 8.0 models were prepared for the following four (4) scenarios:

- **Scenario 2 – 2030 Do Minimum:** Existing intersection layout and future (2030 non-redistributed) volumes. The 2030 volumes are the 2020 volumes with the growth factor applied.
- **Scenario 3 – Option 1 with 2020 traffic:** Existing intersection layout, signalised, and 2020 redistributed volumes (Section 3.8.1)
- **Scenario 4 – Option 2 with 2020 traffic:** New intersection layout, signalised, and 2020 redistributed volumes
- **Scenario 5 – Option 2 with 2030 traffic:** New intersection layout, signalised, and future (2030) redistributed volumes. The 2030 volumes are the 2020 volumes with the growth factor applied.

Option 1 refers to retaining the existing intersection layout but with traffic signals, while Option 2 refers to the new intersection layout with traffic signals.

Scenario 2 will be identical to Scenario 1 other than traffic volumes. For the other three scenarios, the movements removed in Scenario 1 (as detailed in Section 3.9.2) were retained instead and the volumes were rounded up to the minimum value of 1.

The models were prepared for the subject intersection for the same AM and PM peak periods:

- AM Peak: 08:00 to 09:00
- PM Peak: 15:15 to 16:15.



4.4 **SIDRA Intersection Layouts**

4.4.1 **Scenario 2**

The intersection layout in scenario 2 is identical to scenario 1.

4.4.2 **Scenario 3**

The movements omitted in scenarios 1 & 2 are reinstated in the layout of scenario 3. Additionally, pedestrian crossings are added on all four approaches of the intersection. The layout used for scenario 3 is shown in Figure 4.1.

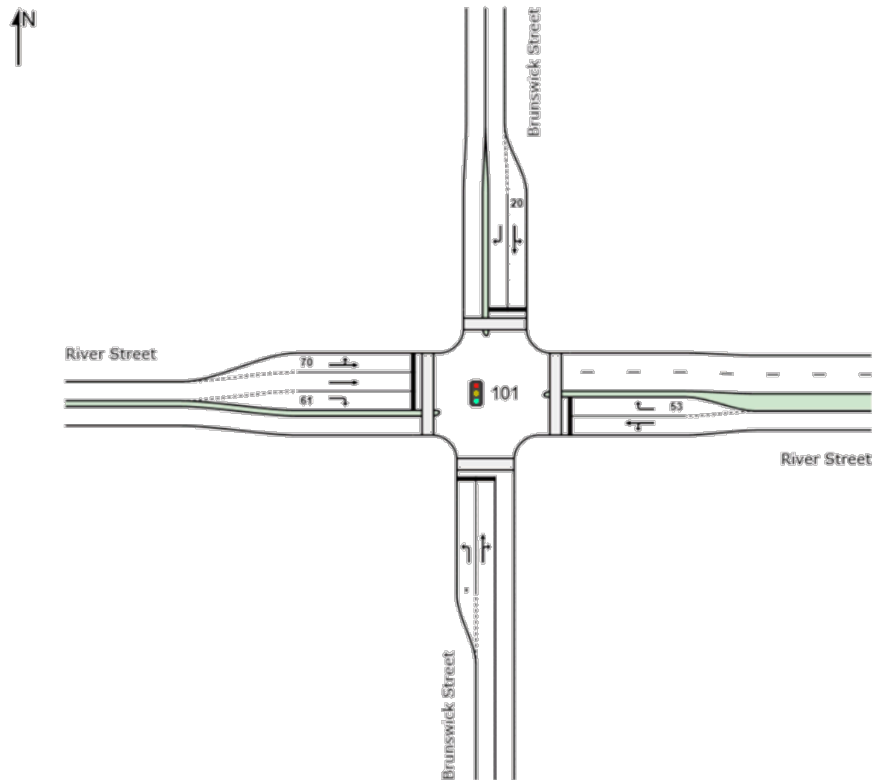

Figure 4.1: SIDRA Geometrical Layout – Scenario 3

4.4.3 **Scenarios 4 & 5**

The proposed layout shown in **Attachment B** was used for the geometrical layouts of scenarios 4 and 5, shown in Figure 4.2. Road widths also reflect the widths annotated in the concept plan.



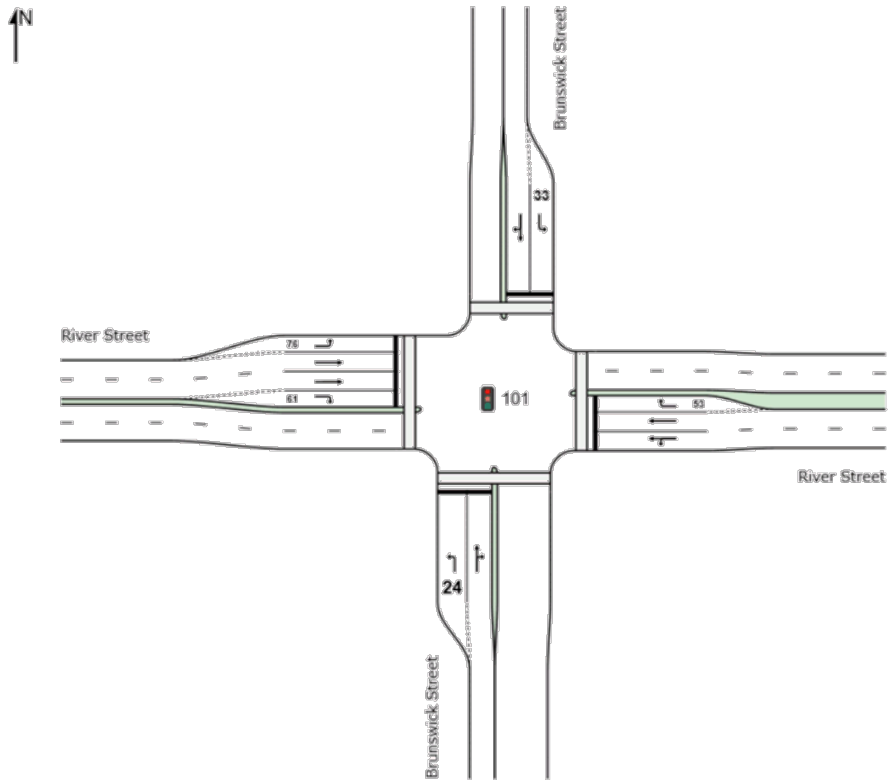

Figure 4.2: SIDRA Geometrical Layout – Scenarios 4 & 5



4.5 Proposed Phase Arrangement

For the scenarios with traffic signals, i.e. scenarios 3, 4 and 5, a 100-second cycle time was used, with individual phase times defined by the program.

4.5.1 Scenario 3 – Existing layout

For scenario 3, the signal cycle has two phases. Phase A is for River Street traffic and parallel pedestrian crossings, while phase B is for Brunswick Street traffic and parallel pedestrian crossings, shown in Figure 4.3. The intergreen time for each phase is six (6) seconds.

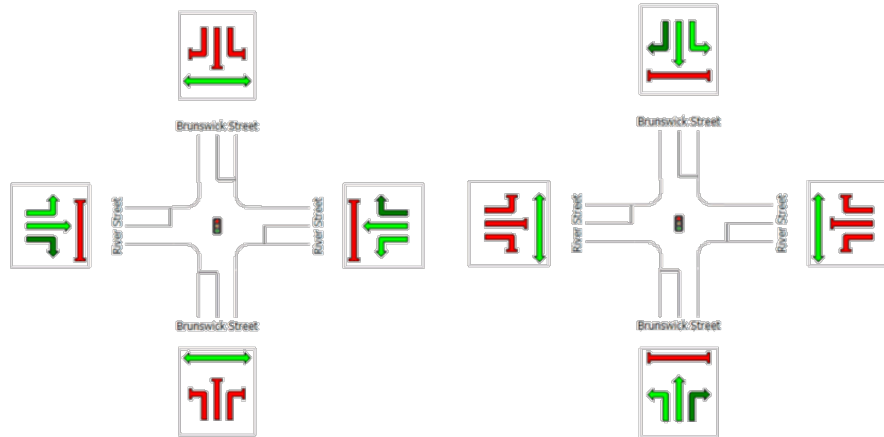

Left: Phase A; Right: Phase B

Figure 4.3: Proposed Intersection Phase Arrangement – Scenario 3

4.5.2 Scenario 4 & 5 – Proposed layout

For scenarios 4 and 5, the signal cycle is similar to scenario 3 but with an additional phase (phase C). Phase C is for dedicated right turns from River Street to Brunswick Street and left turns from Brunswick Street to River Street. Additionally, the filter right turns, which now have 3 lanes of opposing traffic, were removed from phase A.

The phase arrangement for scenarios 4 & 5 are shown in Figure 4.4.

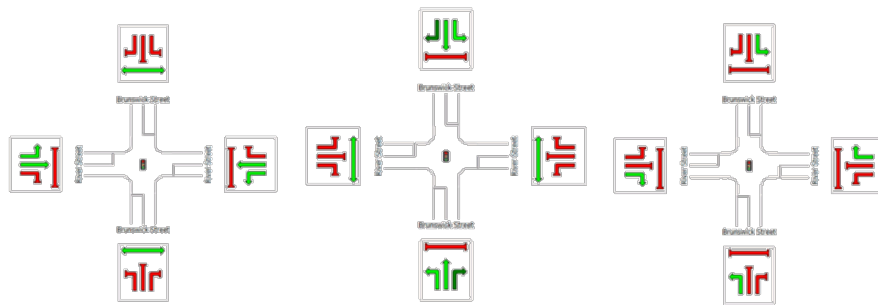

Left: Phase A; Centre: Phase B; Right: Phase C

Figure 4.4: Proposed Intersection Phase Arrangement – Scenario 4 & 5



4.6 Intersection Performance

SIDRA results for all scenarios are shown in **Attachment C**.

4.6.1

4.6.1 Scenario 2 – 2030 Do Minimum

The intersection performance of Scenario 2 for AM and PM peaks are shown in Table 4.1 and Table 4.2 respectively.

Table 4.1: Scenario 2 Intersection Performance - AM Peak

Approach	DOS	Average Delay (s)	LoS	95 th Percentile Queue (m)
Brunswick Street (north)	1.00	116	LOS F	16
River Street (east)	0.62	2	N/A	9
Brunswick Street (south)	1.00	364	LOS F	15
River Street (west)	0.43	0	N/A	1
Overall	1.00	4	N/A	16

Table 4.2: Scenario 2 Intersection Performance - PM Peak

Approach	DOS	Average Delay (s)	LoS	95 th Percentile Queue (m)
Brunswick Street (north)	2.11	580	LOS F	60
River Street (east)	0.81	1	N/A	4
Brunswick Street (south)	0.47	168	LOS F	9
River Street (west)	0.35	1	NA	3
Overall	2.11	14	N/A	60

Under existing conditions with future year traffic, Brunswick Street approaches will continue to have levels of service F in both AM and PM peaks. The average delays of all approaches in both peaks are worse with 2030 volumes than 2020 volumes.

The Brunswick Street approaches will continue to have an average delays of more than 100 seconds in both AM and PM peaks.

4.6.2 Scenario 3 – Option 1 with 2020 traffic

This scenario has little changes to the geometrical layout, but with the intersection signalised and with redistributed current year volumes. The intersection performance of Scenario 3 for AM and PM peaks are shown in Table 4.3 and Table 4.4 respectively.

Table 4.3: Scenario 3 Intersection Performance - AM Peak

Approach	DOS	Average Delay (s)	LoS	95 th Percentile Queue (m)
Brunswick Street (north)	0.38	53	LOS D	20
River Street (east)	0.88	15	LOS B	262
Brunswick Street (south)	0.28	52	LOS D	14
River Street (west)	0.51	5	LOS A	100
Overall	0.88	12	LOS A	262



In the AM peak, the intersection operates at a level of service A. With the exception of the western approach, which operates at level of service A, the other three approaches (River St eastern approach and Brunswick Street) operate at levels of service B or D. This is largely due to these approaches having one lane as opposed to two approach lanes on the western approach.

Delays on Brunswick Street approaches have been lowered, with average delays of both approaches being less than 60 seconds in the AM peak.

For the AM peak, the intersection is modelled on a 100 second cycle time, with 82 seconds phase time allocated to phase A and 18 seconds phase allocated to phase B. Despite 82% of the time given to River Street, the eastern approach continues to experience delays and level of service F.

Table 4.4: Scenario 3 Intersection Performance - PM Peak

Approach	DOS	Average Delay (s)	LoS	95 th Percentile Queue (m)
Brunswick Street (north)	0.37	53	LOS D	19
River Street (east)	1.08	118	LOS F	1033
Brunswick Street (south)	0.34	52	LOS D	17
River Street (west)	0.41	6	LOS A	71
Overall	1.08	66	LOS E	1033

In the PM peak, the intersection operates significantly worse with a level of service E. The performance is worse than AM peak due to the larger westbound volumes on the one-lane eastern approach.

With the exception of the western approach, which operates at level of service A, the other three approaches (River St eastern approach and Brunswick Street) operate at levels of service D or F. The eastern approach is the worst approach with a 95th percentile queue of more than a kilometre long, as it has only one lane accommodating around 1450 vehicles per hour.

Delays on Brunswick Street approaches have been lowered, with average delays of both approaches being less than 60 seconds in the PM peak.

For the PM peak, the intersection is also modelled on a 100 second cycle time, with 82 seconds phase time allocated to phase A and 18 seconds phase allocated to phase B.

4.6.3 Scenario 4 – Option 2 with 2020 traffic

The intersection performance of Scenario 4 for AM and PM peaks are shown in Table 4.5 and Table 4.6 respectively.

Table 4.5: Scenario 4 Intersection Performance - AM Peak

Approach	DOS	Average Delay (s)	LoS	95 th Percentile Queue (m)
Brunswick Street (north)	0.28	44	LOS D	19
River Street (east)	0.48	13	LOS A	109
Brunswick Street (south)	0.21	45	LOS D	14
River Street (west)	0.62	14	LOS A	156
Overall	0.62	15	LOS B	156



Table 4.6: Scenario 4 Intersection Performance - PM Peak

Approach	DOS	Average Delay (s)	LoS	95 th Percentile Queue (m)
Brunswick Street (north)	0.27	43	LOS D	18
River Street (east)	0.62	15	LOS B	160
Brunswick Street (south)	0.23	45	LOS D	16
River Street (west)	0.49	13	LOS A	111
Overall	0.62	16	LOS B	160

With the new intersection layout (additional lanes on Brunswick Street) with the same redistributed current year volumes as Scenario 3, the intersection will operate at a level of service B for both AM and PM peaks. When compared to scenario 3, the intersection has significantly improved for the PM peak. Average delays for the Brunswick Street approaches have also been slightly lowered

The cycle time defined by the program is 100 seconds, with 66 seconds phase time allocated to phase A, 22 seconds allocated to phase B and 12 seconds phase time allocated to phase C. Due to the introduction of a third phase (phase C), the phase time for River Street through movements have been reduced.

4.6.4 Scenario 5 – Option 2 with 2030 traffic

The intersection performance of Scenario 5 for AM and PM peaks are shown in Table 4.7 and Table 4.8 respectively.

Table 4.7: Scenario 5 Intersection Performance - AM Peak

Approach	DOS	Average Delay (s)	LoS	95 th Percentile Queue (m)
Brunswick Street (north)	0.30	44	LOS D	21
River Street (east)	0.53	14	LOS A	124
Brunswick Street (south)	0.20	44	LOS D	14
River Street (west)	0.68	15	LOS B	182
Overall	0.68	16	LOS B	182

Table 4.8: Scenario 5 Intersection Performance - PM Peak

Approach	DOS	Average Delay (s)	LoS	95 th Percentile Queue (m)
Brunswick Street (north)	0.30	43	LOS D	20
River Street (east)	0.68	16	LOS B	186
Brunswick Street (south)	0.23	45	LOS D	16
River Street (west)	0.54	13	LOS A	127
Overall	0.68	16	LOS B	186

With the proposed intersection layout and future year volumes, the intersection will continue to operate at a level of service of B in both AM and PM peaks despite the increase in volumes. Increase to average delays for all approaches in both peaks as compared to 2020 volumes (scenario 4) is minimal.



4.7 Results Discussion

4.7.1 AM Peak

The intersection performance summary of different modelling scenarios for 2020 AM and 2030 AM are shown in Table 4.9 and Table 4.10 respectively.

Table 4.9: Results Summary - 2020 AM Peak

Scenario	Scenario 1 (Base)			Scenario 3 (Option 1)			Scenario 4 (Option 2)		
Layout	Existing Layout						New Layout		
Signals	Non-signalised			Signalised					
Phases	-			2 phases			3 phases		
Approach	DOS	Delay (s)	LoS	DOS	Delay (s)	LoS	DOS	Delay (s)	LoS
Brunswick Street (N)	1.00	128	LOS F	0.38	53	LOS D	0.30	44	LOS D
River Street (E)	0.57	1	N/A	0.88	15	LOS B	0.53	14	LOS A
Brunswick Street (S)	1.00	407	LOS F	0.28	52	LOS D	0.20	44	LOS D
River Street (W)	0.39	0	N/A	0.51	5	LOS A	0.68	15	LOS B
Overall	1.00	5*	N/A	0.88	12	LOS A	0.68	16	LOS B

Table 4.10: Results Summary - 2030 AM Peak

Scenario	Scenario 2 (Do Minimum)			Scenario 5 (Option 2)		
Layout	Existing Layout			New Layout		
Signals	Non-signalised			Signalised		
Phases	-			3 phases		
Approach	DOS	Delay (s)	LoS	DOS	Delay (s)	LoS
Brunswick Street (N)	1.00	116	LOS F	0.30	44	LOS D
River Street (E)	0.62	2	N/A	0.53	14	LOS A
Brunswick Street (S)	1.00	364	LOS F	0.20	44	LOS D
River Street (W)	0.43	0	N/A	0.68	15	LOS B
Overall	1.00	4*	N/A	0.68	16	LOS B

** Note: It is important to note that the average delays for the non-signalised scenarios seem low because the River Street approaches, being the main road in a priority-controlled intersection, have very low or zero average delays. Hence, it is misleading and not advisable to compare the intersection's average delay between non-signalised and signalised scenarios. Instead, the average delays for Brunswick Street approaches should be compared between non-signalised and signalised scenarios.*

From the two tables, there are noticeable improvements in average delays and levels of service on Brunswick Street approaches between signalised and non-signalised scenarios. The average delays are further improved with the new intersection layout.



In scenario 3, the eastern approach has a relatively high degree of saturation of 0.88, due to its one-lane nature. By adding an additional lane as per the new layout (scenario 4), the degree of saturation is lowered to 0.53.

The new signalised layout (scenario 5) will be able to cope with future year AM peak volumes, with acceptable average delays for all approaches.

4.7.2 PM Peak

The intersection performance summary of different modelling scenarios for 2020 PM and 2030 PM are shown in Table 4.11 and Table 4.12 respectively.

Table 4.11: Results Summary - 2020 PM Peak

Scenario	Scenario 1 (Base)			Scenario 3 (Option 1)			Scenario 4 (Option 2)		
Layout	Existing Layout						New Layout		
Signals	Non-signalised			Signalised					
Phases	-			2 phases			3 phases		
Approach	DOS	Delay (s)	LoS	DOS	Delay (s)	LoS	DOS	Delay (s)	LoS
Brunswick Street (N)	1.93	492	LOS F	0.37	53	LOS D	0.30	43	LOS D
River Street (E)	0.74	1	NA	1.08	118	LOS F	0.68	16	LOS B
Brunswick Street (S)	0.20	63	LOS E	0.34	52	LOS D	0.23	45	LOS D
River Street (W)	0.32	1	NA	0.41	6	LOS A	0.54	13	LOS A
Overall	1.93	12*	NA	1.08	66	LOS E	0.68	16	LOS B

Table 4.12: Results Summary - 2030 PM Peak

Scenario	Scenario 2 (Do Minimum)			Scenario 5 (Option 2)			
Layout	Existing Layout						New Layout
Signals	Non-signalised						Signalised
Phases	-						3 phases
Approach	DOS	Delay (s)	LoS	DOS	Delay (s)	LoS	
Brunswick Street (N)	2.11	580	LOS F	0.30	43	LOS D	
River Street (E)	0.81	1	NA	0.68	16	LOS B	
Brunswick Street (S)	0.47	168	LOS F	0.23	45	LOS D	
River Street (W)	0.35	1	NA	0.54	13	LOS A	
Overall	2.11	14*	NA	0.68	16	LOS B	

** Note: Similar to AM peak, it is misleading to compare the average delays between the non-signalised and signalised scenarios, and the average delays for Brunswick Street approaches should be compared instead between non-signalised and signalised scenarios.*



From the two tables, similar to the AM peak, there are noticeable improvements in average delays and levels of service on Brunswick Street approaches between signalised and non-signalised scenarios. The average delays are also further improved with the new intersection layout.

In scenario 3, the one-lane eastern approach is oversaturated with a degree of saturation of 1.08 and a high average delay of 118 seconds. By adding an additional lane as per the new layout, the degree of saturation is lowered to 0.68 and the average delay is lowered to 16 seconds.

The new signalised layout (scenario 5) will be able to cope with future year PM peak volumes, with acceptable average delays for all approaches.

4.8 Summary of SIDRA Modelling Analysis

SIDRA modelling analysis shows that under current conditions but with future year volumes, the intersection will operate worse than it is currently, with Brunswick Street approaches continuing to have levels of service F and excessive average delays.

Signalising the intersection will provide noticeable improvements in average delays and levels of service on Brunswick Street approaches. Additionally, the layout should also be upgraded to further reduce average delays and improve the levels of service in all approaches. In particular, the eastern approach (westbound) should be widened to two lanes to better accommodate the high volumes of westbound traffic.



5. Warrant Criteria Assessment

As mentioned in Section 1.4, the signal warrant and its criteria to be assessed are as follows:

- For each of four one-hour periods of an average day:
 - (i) The major road flow exceeds 900 vehicles/hour in each direction
 - (ii) The minor road exceeds 100 vehicles/hour in one direction
 - (iii) The speed of traffic on the major road or limited sight distance from the minor road causes undue delay or hazard to the minor road vehicles; and
 - (iv) There is no other nearby traffic signal site easily accessible to the minor road vehicles

5.1 Major & Minor Road Flow Criteria

An assessment of hourly flows against the major and minor road flow criteria is shown in Table 5.1.

Table 5.1: Major & Minor Road Flows

Time Period	Major Road Flow					Minor Road Flow		
	Requirements	Western Approach EB		Eastern Approach WB		Requirements	Northern Exit NB	
		Volume (veh/hr)	Criteria Met?	Volume (veh/hr)	Criteria Met?		Volume (veh/hr)	Criteria Met?
AM Peak								
07:00 – 08:00	> 900	826	N	791	N	> 100	47	N
08:00 – 09:00		1,436	Y	1,048	Y		82	N
09:00 – 10:00		1,138	Y	887	N		72	N
PM Peak								
14:30 – 15:30	> 900	1,059	Y	1,291	Y	> 100	86	N
15:30 – 16:30		1,150	Y	1,333	Y		92	N
16:30 – 17:30		997	Y	1,214	Y		73	N

From the table, the major road flow criterion is satisfied, with four one-hour periods having more than 900 vehicles per hour in each direction. However, no one-hour period satisfies the minor road flow criterion, with all the one-hour periods having less than 100 vehicles per hour. The hourly volumes closest to satisfying the criterion of 100 are 82, 86 and 92 vehicles.

With redistributed traffic into the intersection, Brunswick Street will not have volumes of more than 100 at any time. With a traffic growth of 9% in the next 10 years, only one of the one-hour period (15:30 to 16:30, or 15:15 to 16:15) satisfies the requirement, hence not satisfying the criterion.



5.2 **Speed Criteria**

River Street has a posted speed limit of 60 km/h. However, combined with the traffic volumes on River Street, it is difficult and maybe hazardous to turn right from Brunswick Street to River Street. SIDRA analysis in Section 3.9.4 and site visit also identified significant delays in performing such movements. As such, the third criteria of the warrant is satisfied.

5.3 **Nearby Traffic Signal Site Criteria**

The only nearby traffic signal site is the River Street / Kerr Street intersection, located 450 metres east of the subject intersection. This intersection does not accommodate vehicles from Area North intending to travel westbound due to left-turn only restriction from Tamar Street to Kerr Street, as previously mentioned in Section 3.7.1. As such, there are no other easily accessible routes available for Area North vehicles, including the traffic signal site at River Street / Kerr Street, hence satisfying the fourth criteria of the warrant.

On the other hand, the River Street / Kerr Street intersection is able to accommodate vehicles from Area South. However, to access the intersection, vehicles will have to travel through Greenhaigh Street and Camoola Avenue, which are local narrow roads.

5.4 **Summary of Warrants Assessment**

Three of the four criteria were satisfied, being the major road flow, speed and nearby traffic signal site criteria. However, the minor road flow criterion was narrowly not satisfied, as volumes on Brunswick Street are less than 100. The criterion is also not satisfied with redistributed volumes through the intersection or with future traffic volumes.



6. Conclusion

The findings of this study are summarised and outlined below.

Pedestrian Safety

- The nearest controlled crossing to the subject intersection across River Street is the signalised intersection at Kerr Street, located 450 metres east of the subject intersection.
- Alternatively, pedestrians may utilise the pedestrian refuge east of River Street. However, this may not be as safe as pedestrians have to cross three lanes of high-volume 60 km/h traffic. It was observed during the site visit that there are no adequate gaps in traffic for the refuge to be used.

VKT Savings

- The detour routes are at least a kilometre longer than a direct right turn from Brunswick Street north to River Street westbound.
- When all demand from Area North to River Street westbound is redistributed to the right turn from Brunswick Street north to River Street westbound, the VKT savings will be at least 74.2 and 60.2 for AM and PM peaks respectively.

Intersection Delays & SIDRA Modelling

- SIDRA modelling shows high delays in the Brunswick Street approaches at the subject intersection. Delays were confirmed during the site visit.
- The artificially low right turn volumes from Brunswick Street north to River Street westbound, despite demands from Area North to River Street westbound, suggest that drivers are avoiding the right turn by travelling along other detour routes
- The detour routes were proven to be utilised by these drivers based on relatively longer travel times recorded by the OD surveys. However, the proportions of volumes using each detour route cannot be determined due to the lack of OD data east of Kerr Street.
- Similarly, the artificially low right turn volumes from Brunswick Street south to River Street eastbound, despite demands from Area South to Kerr Street or River Street eastbound, suggest that drivers are avoiding by right turn by travelling via Camoola Avenue.
- SIDRA modelling analysis shows that if the intersection is signalised, the average delays in Brunswick Street approaches will be improved to an acceptable level. However, if the layout is unchanged, the eastern approach will have a high average delay and 95th percentile queues in the PM peak.
- If the intersection is upgraded with additional lanes on River Street and road widening with extended turn lanes at Brunswick Street, delays on Brunswick Street approaches are further improved, and delays on the eastern approach will be improved to an acceptable level.

Warrants Assessment

- The subject intersection satisfies three of the four criteria of the signal warrant. The intersection does not satisfy the minor road flow criteria, which states that the minor road (Brunswick Street) has to exceed 100 vehicles/hour in one direction for four one-hour periods of an average day.
- Even with redistributed traffic resulting from the signalising of the subject intersection, Brunswick Street northern and southern approach volumes do not exceed 100 vehicles per hour.



- With traffic growth of 9% applied for the next 10 years, only one of the one-hour period satisfies the requirement, still falling short of the minor road flow criterion.
- Despite one of the warrant criteria not satisfied, other factors such as pedestrian safety, VKT savings, intersection delays and SIDRA modelling must be considered when assessing the merits of signalising the intersection.

In conclusion, retaining the intersection in its current layout will only worsen the intersection performance. By signalising and upgrading the intersection, the performance will significantly improve without bringing significant delays to River Street traffic. Additionally, vehicles from Area North will no longer have to travel detour routes to access River Street westbound. A signalised intersection with crossing will also provide safer pedestrian crossing points between Area North and Area South.



River Street & Brunswick Street, Ballina:
Traffic Signal Warrants Study
Project: P4541 Version: 001

Attachment A: Intersection Counts Diagrams



2020 Existing Volumes

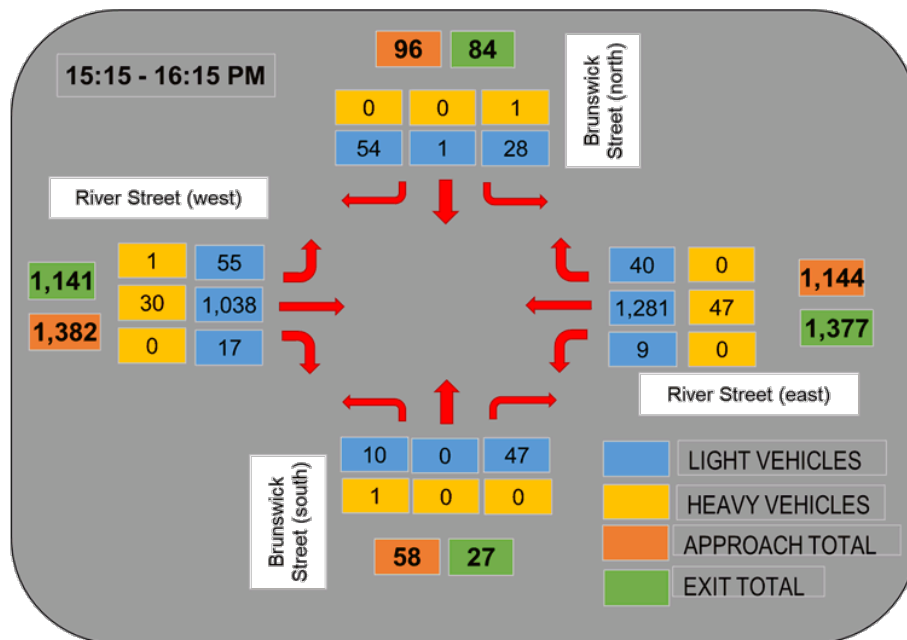
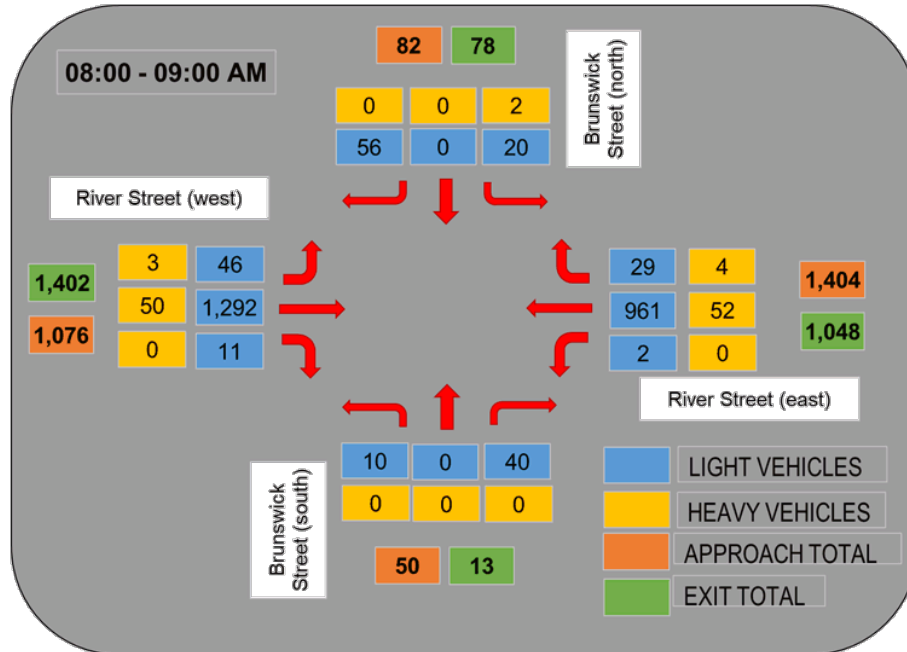

2020 Redistributed Volumes

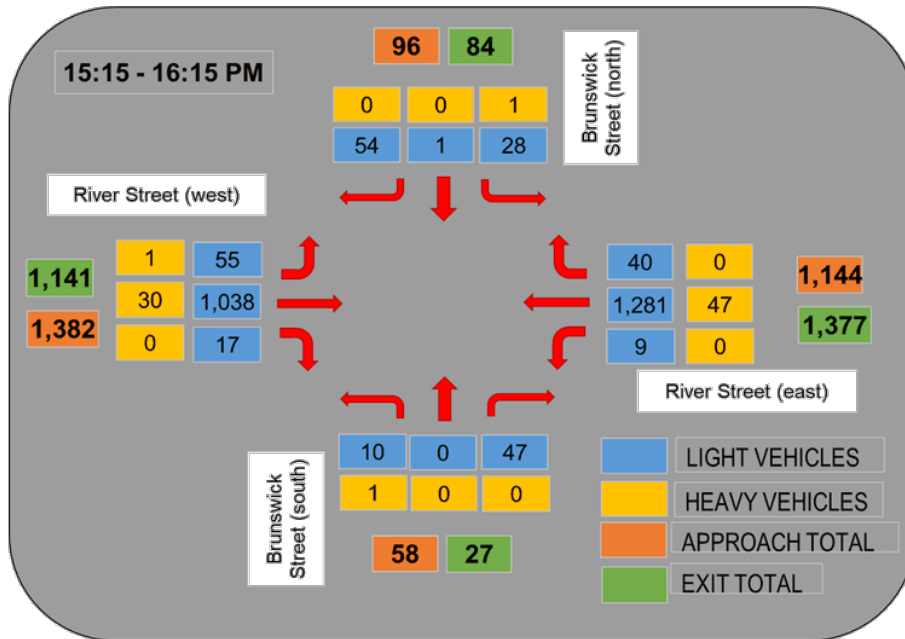
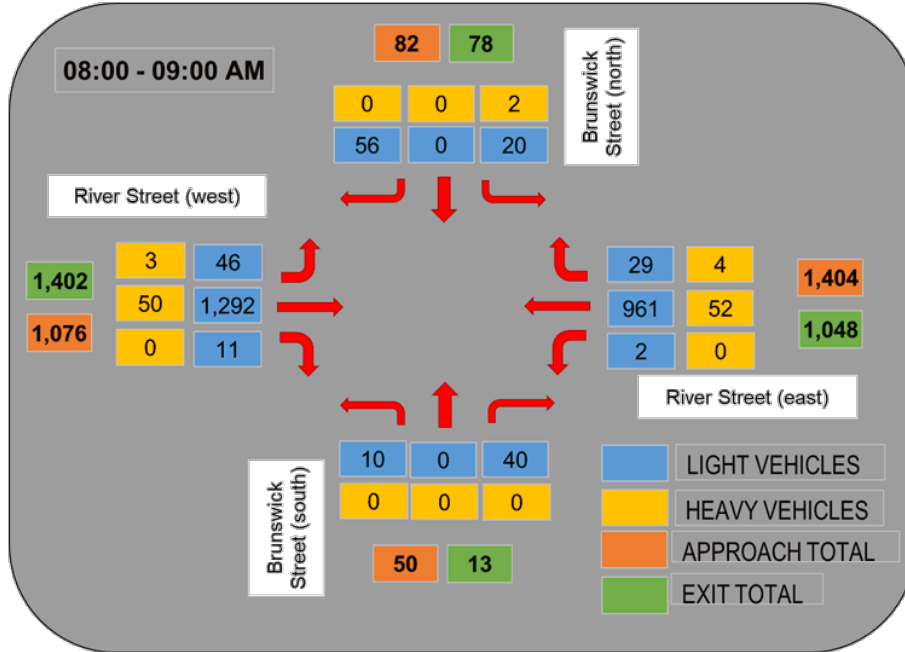

2030 Future Volumes (no redistribution)

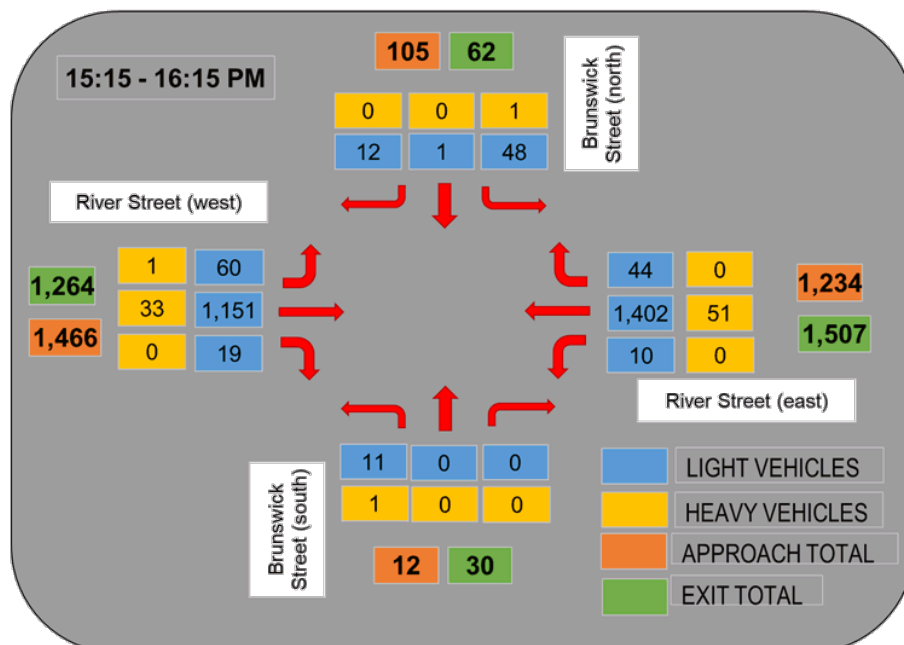
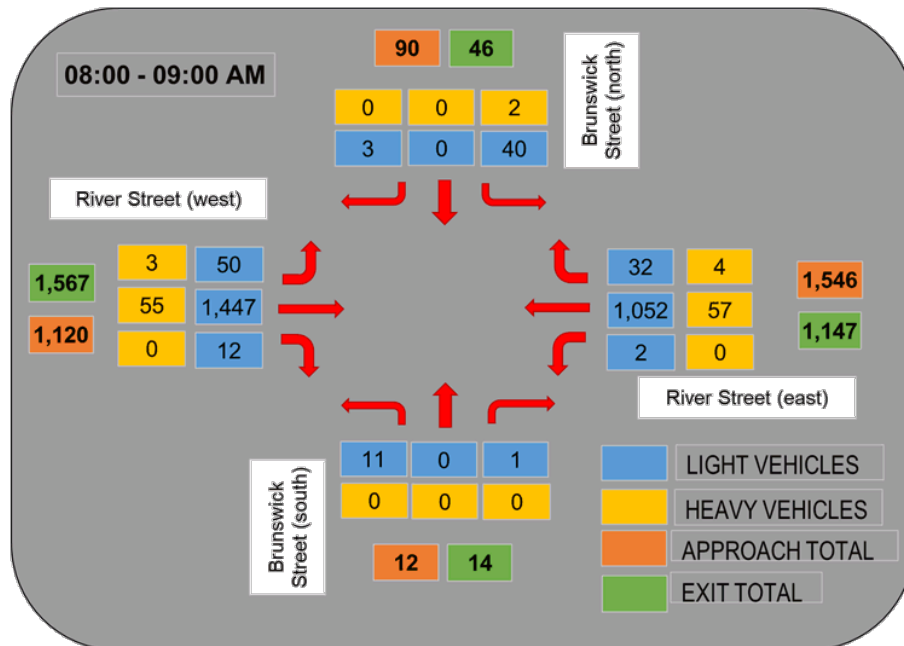

2030 Future Redistributed Volumes

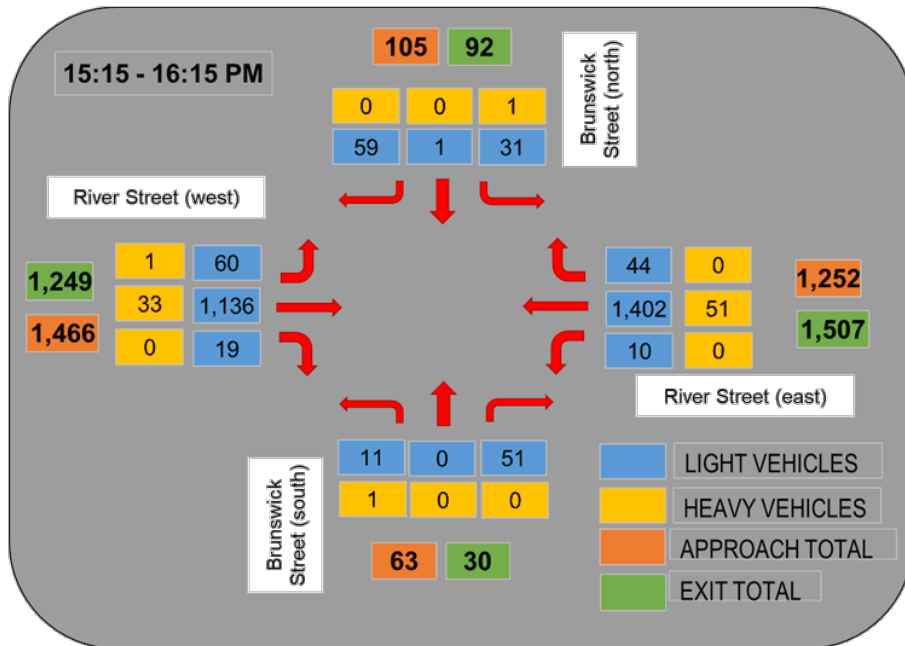
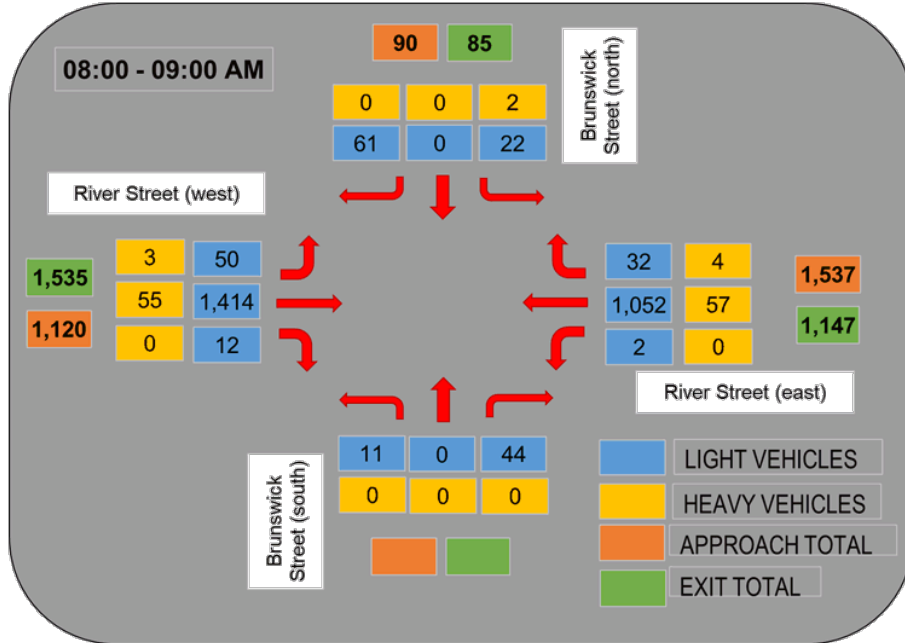

Attachment B: Concept Plan showing Proposed Intersection Layout



7.1 **Proposed Signalisation - Brunswick Street/River Street Intersection, Ballina**

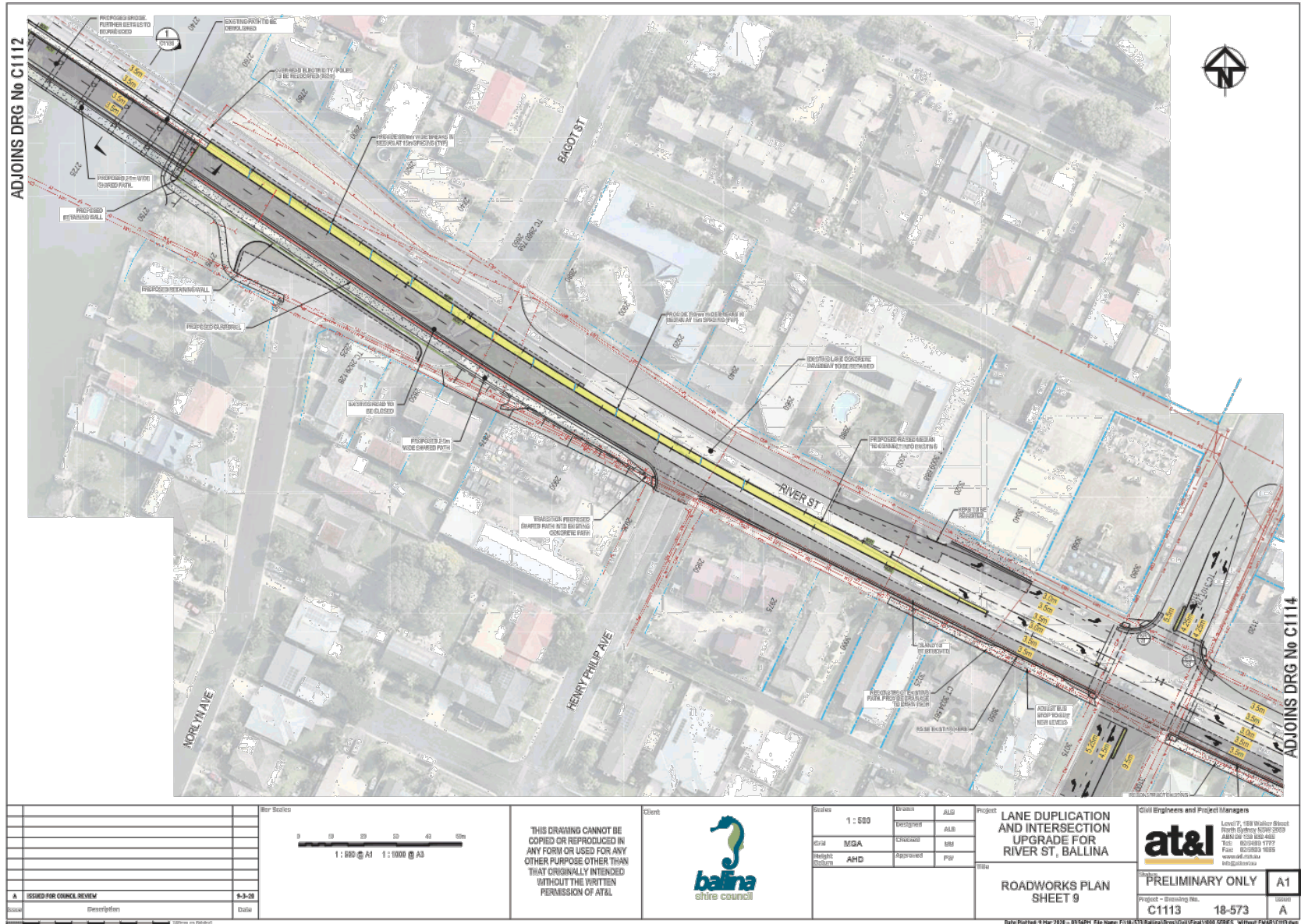

7.1 Proposed Signalisation - Brunswick Street/River Street Intersection, Ballina



<p>ADJOINS DRG No C1113</p>	<p>1 : 500</p> <p>Drawn: ALB</p> <p>Checked: MM</p> <p>Approved: PW</p>	<p>Project: LANE DUPLICATION AND INTERSECTION UPGRADE FOR RIVER ST, BALLINA</p>	<p>Civil Engineers and Project Managers</p> <p>at&I</p> <p>Level 17, 188 Waller Street North Sydney NSW 2060 AUSTRALIA Tel: 002548 17777 Fax: 002548 10555 www.atand.com.au info@atand.com.au</p>
<p>Scale: 1 : 500</p> <p>Drawn: ALB</p> <p>Checked: MM</p> <p>Approved: PW</p>	<p>Project: LANE DUPLICATION AND INTERSECTION UPGRADE FOR RIVER ST, BALLINA</p>	<p>Civil Engineers and Project Managers</p> <p>at&I</p> <p>Level 17, 188 Waller Street North Sydney NSW 2060 AUSTRALIA Tel: 002548 17777 Fax: 002548 10555 www.atand.com.au info@atand.com.au</p>	<p>Scale: 1 : 500</p> <p>Drawn: ALB</p> <p>Checked: MM</p> <p>Approved: PW</p>
<p>Scale: 1 : 500</p> <p>Drawn: ALB</p> <p>Checked: MM</p> <p>Approved: PW</p>	<p>Project: LANE DUPLICATION AND INTERSECTION UPGRADE FOR RIVER ST, BALLINA</p>	<p>Civil Engineers and Project Managers</p> <p>at&I</p> <p>Level 17, 188 Waller Street North Sydney NSW 2060 AUSTRALIA Tel: 002548 17777 Fax: 002548 10555 www.atand.com.au info@atand.com.au</p>	<p>Scale: 1 : 500</p> <p>Drawn: ALB</p> <p>Checked: MM</p> <p>Approved: PW</p>
<p>Scale: 1 : 500</p> <p>Drawn: ALB</p> <p>Checked: MM</p> <p>Approved: PW</p>	<p>Project: LANE DUPLICATION AND INTERSECTION UPGRADE FOR RIVER ST, BALLINA</p>	<p>Civil Engineers and Project Managers</p> <p>at&I</p> <p>Level 17, 188 Waller Street North Sydney NSW 2060 AUSTRALIA Tel: 002548 17777 Fax: 002548 10555 www.atand.com.au info@atand.com.au</p>	<p>Scale: 1 : 500</p> <p>Drawn: ALB</p> <p>Checked: MM</p> <p>Approved: PW</p>

Attachment C: SIDRA Results



MOVEMENT SUMMARY**▽ Site: 101 [River Street / Brunswick Street 2020 Base (Scenario 1) AM]**

River Street / Brunswick Street 2020 Base (Scenario 1) AM
 Site Category: 0800-0900
 Giveway / Yield (Two-Way)

Movement Performance - Vehicles													
Mov ID	Turn	Demand Total	Flows HV %	Deg. Satn v/c	Average Delay sec	Level of Service	95% Back of Queue Vehicles veh	Distance m	Prop. Queued	Effective Stop Rate	Aver. No. Cycles	Average Speed km/h	
South: Brunswick Street													
1	L2	11	0.0	0.043	17.5	LOS B	0.1	0.9	0.82	0.92	0.82	42.4	
3	R2	1	0.0	1.000	4300.9	LOS F	2.2	15.6	1.00	1.02	1.09	0.8	
Approach		12	0.0	1.000	406.9	LOS F	2.2	15.6	0.84	0.93	0.85	7.7	
East: River Street													
4	L2	2	0.0	0.569	5.6	LOS A	0.0	0.0	0.00	0.00	0.00	58.2	
5	T1	1066	5.1	0.569	0.1	LOS A	0.0	0.0	0.00	0.00	0.00	59.8	
6	R2	35	12.1	0.242	33.5	LOS C	0.8	6.0	0.92	0.98	1.00	36.1	
Approach		1103	5.3	0.569	1.2	NA	0.8	6.0	0.03	0.03	0.03	58.6	
North: Brunswick Street													
7	L2	41	5.1	0.075	9.4	LOS A	0.3	1.8	0.60	0.80	0.60	46.6	
9	R2	3	0.0	1.000	1673.1	LOS F	2.4	16.7	1.00	1.05	1.21	2.1	
Approach		44	4.8	1.000	128.2	LOS F	2.4	16.7	0.63	0.82	0.64	18.5	
West: River Street													
10	L2	52	6.1	0.394	5.7	LOS A	0.0	0.0	0.00	0.04	0.00	57.6	
11	T1	1444	3.6	0.394	0.1	LOS A	0.0	0.0	0.00	0.02	0.00	59.7	
12	R2	12	0.0	0.019	11.3	LOS A	0.1	0.5	0.75	0.82	0.75	46.1	
Approach		1507	3.7	0.394	0.3	NA	0.1	0.5	0.01	0.03	0.01	59.5	
All Vehicles		2666	4.4	1.000	4.6	NA	2.4	16.7	0.03	0.05	0.03	55.5	

Site Level of Service (LOS) Method: Delay (RTA NSW). Site LOS Method is specified in the Parameter Settings dialog (Site tab).
 Vehicle movement LOS values are based on average delay per movement.
 Minor Road Approach LOS values are based on average delay for all vehicle movements.
 NA: Intersection LOS and Major Road Approach LOS values are Not Applicable for two-way sign control since the average delay is not a good LOS measure due to zero delays associated with major road movements.
 SIDRA Standard Delay Model is used. Control Delay includes Geometric Delay.
 Gap-Acceptance Capacity: SIDRA Standard (Akçelik M3D).
 HV (%) values are calculated for All Movement Classes of All Heavy Vehicle Model Designation.

SIDRA INTERSECTION 8.0 | Copyright © 2000-2019 Akcelik and Associates Pty Ltd | sidrasolutions.com
 Organisation: BITZIOS CONSULTING | Processed: Monday, 25 May 2020 4:45:00 PM
 Project: P:\P4541 Ballina Traffic Signal Warrants Study\Technical Work\Models\P4541.001M River Street & Brunswick Street.sip8

MOVEMENT SUMMARY**▽ Site: 101 [River Street / Brunswick Street 2020 Base (Scenario 1) PM]**

River Street / Brunswick Street 2020 Base (Scenario 1) PM

Site Category: 1515-1615

Giveaway / Yield (Two-Way)

Movement Performance - Vehicles												
Mov ID	Turn	Demand Total veh/h	Flows HV %	Deg. Satn v/c	Average Delay sec	Level of Service	95% Back of Queue Vehicles veh	Distance m	Prop. Queued	Effective Stop Rate	Aver. No. Cycles	Average Speed km/h
South: Brunswick Street												
1	L2	12	9.1	0.197	63.4	LOS E	0.5	3.8	0.96	0.99	1.00	27.6
Approach		12	9.1	0.197	63.4	LOS E	0.5	3.8	0.96	0.99	1.00	27.6
East: River Street												
4	L2	9	0.0	0.742	5.7	LOS A	0.0	0.0	0.00	0.00	0.00	57.9
5	T1	1398	3.5	0.742	0.2	LOS A	0.0	0.0	0.00	0.00	0.00	59.5
6	R2	42	0.0	0.135	16.6	LOS B	0.4	3.1	0.81	0.92	0.81	43.4
Approach		1449	3.4	0.742	0.8	NA	0.4	3.1	0.02	0.03	0.02	58.8
North: Brunswick Street												
7	L2	47	2.2	0.917	223.1	LOS F	5.5	39.1	0.96	1.67	2.74	10.5
8	T1	1	0.0	0.917	2766.5	LOS F	5.5	39.1	0.96	1.67	2.74	10.4
9	R2	12	0.0	1.930	1383.8	LOS F	7.5	52.4	1.00	1.25	2.15	2.2
Approach		60	1.8	1.930	491.7	LOS F	7.5	52.4	0.97	1.59	2.62	6.1
West: River Street												
10	L2	59	1.8	0.315	5.6	LOS A	0.0	0.0	0.00	0.06	0.00	57.7
11	T1	1139	2.8	0.315	0.0	LOS A	0.0	0.0	0.00	0.03	0.00	59.7
12	R2	18	0.0	0.075	21.4	LOS B	0.2	1.7	0.91	0.96	0.91	40.7
Approach		1216	2.7	0.315	0.6	NA	0.2	1.7	0.01	0.04	0.01	59.2
All Vehicles		2737	3.1	1.930	11.7	NA	7.5	52.4	0.04	0.07	0.08	49.3

Site Level of Service (LOS) Method: Delay (RTA NSW). Site LOS Method is specified in the Parameter Settings dialog (Site tab).

Vehicle movement LOS values are based on average delay per movement.

Minor Road Approach LOS values are based on average delay for all vehicle movements.

NA: Intersection LOS and Major Road Approach LOS values are Not Applicable for two-way sign control since the average delay is not a good LOS measure due to zero delays associated with major road movements.

SIDRA Standard Delay Model is used. Control Delay includes Geometric Delay.

Gap-Acceptance Capacity: SIDRA Standard (Akçelik M3D).

HV (%) values are calculated for All Movement Classes of All Heavy Vehicle Model Designation.

SIDRA INTERSECTION 8.0 | Copyright © 2000-2019 Akcelik and Associates Pty Ltd | sidrasolutions.com

Organisation: BITZIOS CONSULTING | Processed: Monday, 25 May 2020 4:45:11 PM

Project: P:\P4541 Ballina Traffic Signal Warrants Study\Technical Work\Models\P4541.001M River Street & Brunswick Street.sip8

MOVEMENT SUMMARY**▽ Site: 101 [River Street / Brunswick Street 2030 Do Minimum (Scenario 2) AM]**

River Street / Brunswick Street 2030 Do Minimum (Scenario 2) AM

Site Category: 0800-0900

Giveway / Yield (Two-Way)

Movement Performance - Vehicles													
Mov ID	Turn	Demand Total	Flows HV %	Deg. Satn v/c	Average Delay sec	Level of Service	95% Back of Queue Vehicles veh	Distance m	Prop. Queued	Effective Stop Rate	Aver. No. Cycles	Average Speed km/h	
South: Brunswick Street													
1	L2	12	0.0	0.065	22.7	LOS B	0.2	1.3	0.87	0.94	0.87	39.9	
3	R2	1	0.0	1.000	4120.2	LOS F	2.1	15.0	1.00	1.02	1.09	0.9	
Approach		13	0.0	1.000	364.2	LOS F	2.1	15.0	0.88	0.95	0.89	8.4	
East: River Street													
4	L2	2	0.0	0.624	5.7	LOS A	0.0	0.0	0.00	0.00	0.00	58.1	
5	T1	1167	5.1	0.624	0.1	LOS A	0.0	0.0	0.00	0.00	0.00	59.7	
6	R2	38	11.1	0.361	48.4	LOS D	1.2	8.8	0.95	1.01	1.10	31.5	
Approach		1207	5.3	0.624	1.7	NA	1.2	8.8	0.03	0.03	0.03	58.1	
North: Brunswick Street													
7	L2	44	4.8	0.090	10.3	LOS A	0.3	2.2	0.65	0.83	0.65	46.1	
9	R2	3	0.0	1.000	1601.8	LOS F	2.3	16.0	1.00	1.05	1.21	2.2	
Approach		47	4.4	1.000	116.4	LOS F	2.3	16.0	0.67	0.85	0.68	19.7	
West: River Street													
10	L2	56	5.7	0.431	5.7	LOS A	0.0	0.0	0.00	0.04	0.00	57.6	
11	T1	1581	3.7	0.431	0.1	LOS A	0.0	0.0	0.00	0.02	0.00	59.7	
12	R2	13	0.0	0.026	13.1	LOS A	0.1	0.7	0.80	0.89	0.80	45.1	
Approach		1649	3.7	0.431	0.4	NA	0.1	0.7	0.01	0.03	0.01	59.5	
All Vehicles		2917	4.4	1.000	4.4	NA	2.3	16.0	0.03	0.05	0.03	55.6	

Site Level of Service (LOS) Method: Delay (RTA NSW). Site LOS Method is specified in the Parameter Settings dialog (Site tab).

Vehicle movement LOS values are based on average delay per movement.

Minor Road Approach LOS values are based on average delay for all vehicle movements.

NA: Intersection LOS and Major Road Approach LOS values are Not Applicable for two-way sign control since the average delay is not a good LOS measure due to zero delays associated with major road movements.

SIDRA Standard Delay Model is used. Control Delay includes Geometric Delay.

Gap-Acceptance Capacity: SIDRA Standard (Akçelik M3D).

HV (%) values are calculated for All Movement Classes of All Heavy Vehicle Model Designation.

SIDRA INTERSECTION 8.0 | Copyright © 2000-2019 Akcelik and Associates Pty Ltd | sidrasolutions.com

Organisation: BITZIOS CONSULTING | Processed: Monday, 25 May 2020 4:45:31 PM

Project: P:\P4541 Ballina Traffic Signal Warrants Study\Technical Work\Models\P4541.001M River Street & Brunswick Street.sip8

MOVEMENT SUMMARY**▽ Site: 101 [River Street / Brunswick Street 2030 Do Minimum (Scenario 2) PM]**

River Street / Brunswick Street 2030 Do Minimum (Scenario 2) PM

Site Category: 1515-1615

Giveaway / Yield (Two-Way)

Movement Performance - Vehicles												
Mov ID	Turn	Demand Total veh/h	Flows HV %	Deg. Satn v/c	Average Delay sec	Level of Service	95% Back of Queue Vehicles veh	Distance m	Prop. Queued	Effective Stop Rate	Aver. No. Cycles	Average Speed km/h
South: Brunswick Street												
1	L2	13	8.3	0.465	167.9	LOS F	1.2	8.8	0.99	1.02	1.10	15.4
Approach		13	8.3	0.465	167.9	LOS F	1.2	8.8	0.99	1.02	1.10	15.4
East: River Street												
4	L2	11	0.0	0.808	5.8	LOS A	0.0	0.0	0.00	0.00	0.00	57.7
5	T1	1529	3.5	0.808	0.4	LOS A	0.0	0.0	0.00	0.00	0.00	59.3
6	R2	46	0.0	0.182	19.9	LOS B	0.6	4.2	0.85	0.94	0.87	41.7
Approach		1586	3.4	0.808	1.0	NA	0.6	4.2	0.02	0.03	0.03	58.5
North: Brunswick Street												
7	L2	52	2.0	1.079	308.9	LOS F	8.4	59.7	1.00	2.05	3.81	8.3
8	T1	1	0.0	1.079	3126.6	LOS F	8.4	59.7	1.00	2.05	3.81	8.2
9	R2	13	0.0	2.105	1473.4	LOS F	8.3	58.1	1.00	1.28	2.28	2.1
Approach		65	1.6	2.105	579.7	LOS F	8.4	59.7	1.00	1.90	3.52	5.3
West: River Street												
10	L2	64	1.6	0.345	5.6	LOS A	0.0	0.0	0.00	0.06	0.00	57.7
11	T1	1246	2.8	0.345	0.0	LOS A	0.0	0.0	0.00	0.03	0.00	59.7
12	R2	20	0.0	0.149	33.5	LOS C	0.5	3.2	0.95	0.98	0.95	35.8
Approach		1331	2.7	0.345	0.8	NA	0.5	3.2	0.01	0.04	0.01	59.0
All Vehicles		2995	3.1	2.105	14.2	NA	8.4	59.7	0.05	0.08	0.10	47.6

Site Level of Service (LOS) Method: Delay (RTA NSW). Site LOS Method is specified in the Parameter Settings dialog (Site tab).

Vehicle movement LOS values are based on average delay per movement.

Minor Road Approach LOS values are based on average delay for all vehicle movements.

NA: Intersection LOS and Major Road Approach LOS values are Not Applicable for two-way sign control since the average delay is not a good LOS measure due to zero delays associated with major road movements.

SIDRA Standard Delay Model is used. Control Delay includes Geometric Delay.

Gap-Acceptance Capacity: SIDRA Standard (Akçelik M3D).

HV (%) values are calculated for All Movement Classes of All Heavy Vehicle Model Designation.

SIDRA INTERSECTION 8.0 | Copyright © 2000-2019 Akcelik and Associates Pty Ltd | sidrasolutions.com

Organisation: BITZIOS CONSULTING | Processed: Monday, 25 May 2020 4:45:55 PM

Project: P:\P4541 Ballina Traffic Signal Warrants Study\Technical Work\Models\P4541.001M River Street & Brunswick Street.sip8

MOVEMENT SUMMARY**Site: 101 [River Street / Brunswick Street Option 1 with 2020 traffic (Scenario 3) AM]**

River Street / Brunswick Street Option 1 with 2020 traffic (Scenario 3) AM

Site Category: 0800-0900

Signals - Fixed Time Isolated Cycle Time = 100 seconds (Site User-Given Cycle Time)

Variable Sequence Analysis applied. The results are given for the selected output sequence.

Movement Performance - Vehicles												
Mov ID	Turn	Demand Total veh/h	Flows HV %	Deg. Satn v/c	Average Delay sec	Level of Service	95% Back of Queue Vehicles veh	Distance m	Prop. Queued	Effective Stop Rate	Aver. No. Cycles	Average Speed km/h
South: Brunswick Street												
1	L2	11	0.0	0.063	50.8	LOS D	0.5	3.4	0.94	0.67	0.94	30.6
2	T1	1	0.0	0.278	47.3	LOS D	2.1	14.4	0.96	0.74	0.96	29.3
3	R2	42	0.0	0.278	51.8	LOS D	2.1	14.4	0.96	0.74	0.96	30.2
Approach		54	0.0	0.278	51.5	LOS D	2.1	14.4	0.96	0.73	0.96	30.3
East: River Street												
4	L2	2	0.0	0.879	20.9	LOS B	35.8	261.8	0.60	0.63	0.69	44.0
5	T1	1066	5.1	0.879	15.3	LOS B	35.8	261.8	0.60	0.63	0.69	47.9
6	R2	35	12.1	0.213	15.8	LOS B	0.8	6.3	0.47	0.69	0.47	43.7
Approach		1103	5.3	0.879	15.4	LOS B	35.8	261.8	0.60	0.63	0.68	47.8
North: Brunswick Street												
7	L2	23	9.1	0.152	50.9	LOS D	1.1	8.5	0.95	0.71	0.95	30.5
8	T1	1	0.0	0.152	46.3	LOS D	1.1	8.5	0.95	0.71	0.95	29.5
9	R2	59	0.0	0.382	53.4	LOS D	2.9	20.1	0.98	0.75	0.98	30.0
Approach		83	2.5	0.382	52.6	LOS D	2.9	20.1	0.97	0.74	0.97	30.1
West: River Street												
10	L2	52	6.1	0.508	10.6	LOS A	13.7	98.9	0.42	0.41	0.42	50.0
11	T1	1413	3.7	0.508	5.0	LOS A	13.8	99.5	0.42	0.40	0.42	55.3
12	R2	12	0.0	0.064	23.0	LOS B	0.3	2.3	0.59	0.68	0.59	40.1
Approach		1476	3.8	0.508	5.3	LOS A	13.8	99.5	0.42	0.40	0.42	54.9
All Vehicles		2716	4.3	0.879	11.7	LOS A	35.8	261.8	0.52	0.51	0.56	49.8

Site Level of Service (LOS) Method: Delay (RTA NSW). Site LOS Method is specified in the Parameter Settings dialog (Site tab).

Vehicle movement LOS values are based on average delay per movement.

Intersection and Approach LOS values are based on average delay for all vehicle movements.

SIDRA Standard Delay Model is used. Control Delay includes Geometric Delay.

Gap-Acceptance Capacity: SIDRA Standard (Akçelik M3D).

HV (%) values are calculated for All Movement Classes of All Heavy Vehicle Model Designation.

Movement Performance - Pedestrians									
Mov ID	Description	Demand Flow ped/h	Average Delay sec	Level of Service	Average Back of Queue Pedestrian ped	Distance m	Prop. Queued	Effective Stop Rate	
P1	South Full Crossing	53	44.3	LOS E	0.1	0.1	0.94	0.94	
P2	East Full Crossing	53	44.3	LOS E	0.1	0.1	0.94	0.94	
P3	North Full Crossing	53	44.3	LOS E	0.1	0.1	0.94	0.94	
P4	West Full Crossing	53	44.3	LOS E	0.1	0.1	0.94	0.94	
All Pedestrians		211	44.3	LOS E			0.94	0.94	

Level of Service (LOS) Method: SIDRA Pedestrian LOS Method (Based on Average Delay)

Pedestrian movement LOS values are based on average delay per pedestrian movement.

Intersection LOS value for Pedestrians is based on average delay for all pedestrian movements.

MOVEMENT SUMMARY**Site: 101 [River Street / Brunswick Street Option 1 with 2020 traffic (Scenario 3) PM]**

River Street / Brunswick Street Option 1 with 2020 traffic (Scenario 3) PM

Site Category: 1515-1615

Signals - Fixed Time Isolated Cycle Time = 100 seconds (Site User-Given Cycle Time)

Variable Sequence Analysis applied. The results are given for the selected output sequence.

Movement Performance - Vehicles												
Mov ID	Turn	Demand Total veh/h	Flows HV %	Deg. Satn v/c	Average Delay sec	Level of Service	95% Back of Queue Vehicles veh	Distance m	Prop. Queued	Effective Stop Rate	Aver. No. Cycles	Average Speed km/h
South: Brunswick Street												
1	L2	12	9.1	0.074	51.2	LOS D	0.5	4.0	0.94	0.68	0.94	30.4
2	T1	1	0.0	0.343	47.7	LOS D	2.4	17.0	0.97	0.75	0.97	29.1
3	R2	49	0.0	0.343	52.3	LOS D	2.4	17.0	0.97	0.75	0.97	30.1
Approach		62	1.7	0.343	52.0	LOS D	2.4	17.0	0.96	0.73	0.96	30.1
East: River Street												
4	L2	9	0.0	1.078	126.8	LOS F	143.2	1032.8	1.00	1.70	1.94	19.2
5	T1	1398	3.5	1.078	121.2	LOS F	143.2	1032.8	1.00	1.70	1.94	19.9
6	R2	42	0.0	0.154	12.7	LOS A	0.8	5.6	0.40	0.67	0.40	45.5
Approach		1449	3.4	1.078	118.1	LOS F	143.2	1032.8	0.98	1.67	1.90	20.3
North: Brunswick Street												
7	L2	31	3.4	0.192	51.1	LOS D	1.5	10.6	0.95	0.72	0.95	30.5
8	T1	1	0.0	0.192	46.5	LOS D	1.5	10.6	0.95	0.72	0.95	29.5
9	R2	57	0.0	0.371	53.3	LOS D	2.8	19.3	0.98	0.75	0.98	30.0
Approach		88	1.2	0.371	52.5	LOS D	2.8	19.3	0.97	0.74	0.97	30.1
West: River Street												
10	L2	59	1.8	0.408	10.0	LOS A	9.8	70.3	0.38	0.38	0.38	50.3
11	T1	1124	2.8	0.408	4.4	LOS A	9.9	71.0	0.38	0.36	0.38	55.7
12	R2	18	0.0	0.226	60.6	LOS E	0.9	6.5	1.00	0.68	1.00	28.4
Approach		1201	2.7	0.408	5.5	LOS A	9.9	71.0	0.39	0.36	0.39	54.6
All Vehicles		2801	3.0	1.078	66.3	LOS E	143.2	1032.8	0.73	1.06	1.20	28.4

Site Level of Service (LOS) Method: Delay (RTA NSW). Site LOS Method is specified in the Parameter Settings dialog (Site tab).

Vehicle movement LOS values are based on average delay per movement.

Intersection and Approach LOS values are based on average delay for all vehicle movements.

SIDRA Standard Delay Model is used. Control Delay includes Geometric Delay.

Gap-Acceptance Capacity: SIDRA Standard (Akçelik M3D).

HV (%) values are calculated for All Movement Classes of All Heavy Vehicle Model Designation.

Movement Performance - Pedestrians									
Mov ID	Description	Demand Flow ped/h	Average Delay sec	Level of Service	Average Back of Queue Pedestrian ped	Distance m	Prop. Queued	Effective Stop Rate	
P1	South Full Crossing	53	44.3	LOS E	0.1	0.1	0.94	0.94	
P2	East Full Crossing	53	44.3	LOS E	0.1	0.1	0.94	0.94	
P3	North Full Crossing	53	44.3	LOS E	0.1	0.1	0.94	0.94	
P4	West Full Crossing	53	44.3	LOS E	0.1	0.1	0.94	0.94	
All Pedestrians		211	44.3	LOS E			0.94	0.94	

Level of Service (LOS) Method: SIDRA Pedestrian LOS Method (Based on Average Delay)

Pedestrian movement LOS values are based on average delay per pedestrian movement.

Intersection LOS value for Pedestrians is based on average delay for all pedestrian movements.

MOVEMENT SUMMARY**Site: 101 [River Street / Brunswick Street Option 2 with 2020 traffic (Scenario 4) AM]**

River Street / Brunswick Street Option 2 with 2020 traffic (Scenario 4) AM

Site Category: 0800-0900

Signals - Fixed Time Isolated Cycle Time = 100 seconds (Site User-Given Cycle Time)

Variable Sequence Analysis applied. The results are given for the selected output sequence.

Movement Performance - Vehicles												
Mov ID	Turn	Demand Total veh/h	Flows HV %	Deg. Satn v/c	Average Delay sec	Level of Service	95% Back of Queue Vehicles veh	Back of Queue Distance m	Prop. Queued	Effective Stop Rate	Aver. No. Cycles	Average Speed km/h
South: Brunswick Street												
1	L2	11	0.0	0.021	34.6	LOS C	0.4	2.7	0.78	0.66	0.78	35.3
2	T1	1	0.0	0.208	42.5	LOS D	1.9	13.5	0.92	0.73	0.92	30.5
3	R2	42	0.0	0.208	47.0	LOS D	1.9	13.5	0.92	0.73	0.92	31.9
Approach		54	0.0	0.208	44.5	LOS D	1.9	13.5	0.89	0.72	0.89	32.5
East: River Street												
4	L2	2	0.0	0.480	17.5	LOS B	14.9	108.6	0.61	0.54	0.61	46.0
5	T1	1066	5.1	0.480	11.8	LOS A	14.9	108.6	0.60	0.54	0.60	50.3
6	R2	35	12.1	0.344	58.1	LOS E	1.8	13.6	0.99	0.73	0.99	29.2
Approach		1103	5.3	0.480	13.3	LOS A	14.9	108.6	0.61	0.54	0.61	49.2
North: Brunswick Street												
7	L2	23	9.1	0.051	35.2	LOS C	0.9	6.5	0.79	0.69	0.79	35.0
8	T1	1	0.0	0.279	43.0	LOS D	2.7	19.1	0.93	0.75	0.93	30.4
9	R2	59	0.0	0.279	47.6	LOS D	2.7	19.1	0.93	0.75	0.93	31.7
Approach		83	2.5	0.279	44.1	LOS D	2.7	19.1	0.89	0.73	0.89	32.5
West: River Street												
10	L2	52	6.1	0.052	15.6	LOS B	1.1	8.0	0.46	0.67	0.46	43.8
11	T1	1413	3.7	0.620	13.4	LOS A	21.5	155.6	0.68	0.62	0.68	49.2
12	R2	12	0.0	0.106	56.2	LOS D	0.6	4.0	0.97	0.68	0.97	29.8
Approach		1476	3.8	0.620	13.9	LOS A	21.5	155.6	0.68	0.62	0.68	48.7
All Vehicles		2716	4.3	0.620	15.2	LOS B	21.5	155.6	0.66	0.59	0.66	47.7

Site Level of Service (LOS) Method: Delay (RTA NSW). Site LOS Method is specified in the Parameter Settings dialog (Site tab).

Vehicle movement LOS values are based on average delay per movement.

Intersection and Approach LOS values are based on average delay for all vehicle movements.

SIDRA Standard Delay Model is used. Control Delay includes Geometric Delay.

Gap-Acceptance Capacity: SIDRA Standard (Akçelik M3D).

HV (%) values are calculated for All Movement Classes of All Heavy Vehicle Model Designation.

Movement Performance - Pedestrians									
Mov ID	Description	Demand Flow ped/h	Average Delay sec	Level of Service	Average Back of Queue Pedestrian ped	Back of Queue Distance m	Prop. Queued	Effective Stop Rate	
P1	South Full Crossing	53	44.3	LOS E	0.1	0.1	0.94	0.94	
P2	East Full Crossing	53	44.3	LOS E	0.1	0.1	0.94	0.94	
P3	North Full Crossing	53	44.3	LOS E	0.1	0.1	0.94	0.94	
P4	West Full Crossing	53	44.3	LOS E	0.1	0.1	0.94	0.94	
All Pedestrians		211	44.3	LOS E			0.94	0.94	

Level of Service (LOS) Method: SIDRA Pedestrian LOS Method (Based on Average Delay)

Pedestrian movement LOS values are based on average delay per pedestrian movement.

Intersection LOS value for Pedestrians is based on average delay for all pedestrian movements.

MOVEMENT SUMMARY**Site: 101 [River Street / Brunswick Street Option 2 with 2020 traffic (Scenario 4) PM]**

River Street / Brunswick Street Option 2 with 2020 traffic (Scenario 4) PM

Site Category: 1515-1615

Signals - Fixed Time Isolated Cycle Time = 100 seconds (Site User-Given Cycle Time)

Variable Sequence Analysis applied. The results are given for the selected output sequence.

Movement Performance - Vehicles												
Mov ID	Turn	Demand Total veh/h	Flows HV %	Deg. Satn v/c	Average Delay sec	Level of Service	95% Back of Queue Vehicles veh	Distance m	Prop. Queued	Effective Stop Rate	Aver. No. Cycles	Average Speed km/h
South: Brunswick Street												
1	L2	12	9.1	0.024	34.8	LOS C	0.4	3.2	0.78	0.66	0.78	35.1
2	T1	1	0.0	0.232	42.6	LOS D	2.3	15.9	0.93	0.74	0.93	30.5
3	R2	49	0.0	0.232	47.1	LOS D	2.3	15.9	0.93	0.74	0.93	31.9
Approach		62	1.7	0.232	44.8	LOS D	2.3	15.9	0.90	0.72	0.90	32.4
East: River Street												
4	L2	9	0.0	0.624	19.1	LOS B	22.2	160.1	0.69	0.63	0.69	45.0
5	T1	1398	3.5	0.624	13.4	LOS A	22.2	160.1	0.68	0.62	0.68	49.2
6	R2	42	0.0	0.384	57.9	LOS E	2.1	14.9	1.00	0.73	1.00	29.3
Approach		1449	3.4	0.624	14.8	LOS B	22.2	160.1	0.69	0.62	0.69	48.2
North: Brunswick Street												
7	L2	31	3.4	0.064	35.3	LOS C	1.1	8.2	0.79	0.70	0.79	35.1
8	T1	1	0.0	0.270	43.0	LOS D	2.6	18.4	0.93	0.75	0.93	30.4
9	R2	57	0.0	0.270	47.5	LOS D	2.6	18.4	0.93	0.75	0.93	31.7
Approach		88	1.2	0.270	43.2	LOS D	2.6	18.4	0.88	0.73	0.88	32.8
West: River Street												
10	L2	59	1.8	0.057	15.6	LOS B	1.3	8.9	0.47	0.67	0.47	43.9
11	T1	1124	2.8	0.490	12.0	LOS A	15.5	111.2	0.61	0.54	0.61	50.2
12	R2	18	0.0	0.163	56.7	LOS E	0.9	6.2	0.98	0.69	0.98	29.7
Approach		1201	2.7	0.490	12.8	LOS A	15.5	111.2	0.61	0.55	0.61	49.3
All Vehicles		2801	3.0	0.624	15.5	LOS B	22.2	160.1	0.67	0.60	0.67	47.5

Site Level of Service (LOS) Method: Delay (RTA NSW). Site LOS Method is specified in the Parameter Settings dialog (Site tab).

Vehicle movement LOS values are based on average delay per movement.

Intersection and Approach LOS values are based on average delay for all vehicle movements.

SIDRA Standard Delay Model is used. Control Delay includes Geometric Delay.

Gap-Acceptance Capacity: SIDRA Standard (Akçelik M3D).

HV (%) values are calculated for All Movement Classes of All Heavy Vehicle Model Designation.

Movement Performance - Pedestrians									
Mov ID	Description	Demand Flow ped/h	Average Delay sec	Level of Service	Average Back of Queue Pedestrian ped	Distance m	Prop. Queued	Effective Stop Rate	
P1	South Full Crossing	53	44.3	LOS E	0.1	0.1	0.94	0.94	
P2	East Full Crossing	53	44.3	LOS E	0.1	0.1	0.94	0.94	
P3	North Full Crossing	53	44.3	LOS E	0.1	0.1	0.94	0.94	
P4	West Full Crossing	53	44.3	LOS E	0.1	0.1	0.94	0.94	
All Pedestrians		211	44.3	LOS E			0.94	0.94	

Level of Service (LOS) Method: SIDRA Pedestrian LOS Method (Based on Average Delay)

Pedestrian movement LOS values are based on average delay per pedestrian movement.

Intersection LOS value for Pedestrians is based on average delay for all pedestrian movements.

MOVEMENT SUMMARY**Site: 101 [River Street / Brunswick Street Option 2 with 2030 traffic (Scenario 5) AM]**

River Street / Brunswick Street Option 2 with 2030 traffic (Scenario 5) AM

Site Category: 0800-0900

Signals - Fixed Time Isolated Cycle Time = 100 seconds (Site User-Given Cycle Time)

Variable Sequence Analysis applied. The results are given for the selected output sequence.

Movement Performance - Vehicles												
Mov ID	Turn	Demand Total veh/h	Flows HV %	Deg. Satn v/c	Average Delay sec	Level of Service	95% Back of Queue Vehicles veh	Back of Queue Distance m	Prop. Queued	Effective Stop Rate	Aver. No. Cycles	Average Speed km/h
South: Brunswick Street												
1	L2	12	0.0	0.023	34.7	LOS C	0.4	2.9	0.78	0.66	0.78	35.3
2	T1	1	0.0	0.195	42.3	LOS C	1.9	13.5	0.92	0.73	0.92	30.6
3	R2	42	0.0	0.195	46.8	LOS D	1.9	13.5	0.92	0.73	0.92	32.0
Approach		55	0.0	0.195	44.1	LOS D	1.9	13.5	0.89	0.72	0.89	32.6
East: River Street												
4	L2	2	0.0	0.525	18.0	LOS B	16.9	123.6	0.63	0.57	0.63	45.7
5	T1	1167	5.1	0.525	12.3	LOS A	16.9	123.6	0.62	0.56	0.62	50.0
6	R2	38	11.1	0.373	58.3	LOS E	1.9	14.7	1.00	0.73	1.00	29.2
Approach		1207	5.3	0.525	13.7	LOS A	16.9	123.6	0.63	0.56	0.63	48.9
North: Brunswick Street												
7	L2	25	8.3	0.055	35.2	LOS C	0.9	7.0	0.79	0.69	0.79	35.0
8	T1	1	0.0	0.304	43.2	LOS D	3.0	20.8	0.94	0.75	0.94	30.3
9	R2	64	0.0	0.304	47.8	LOS D	3.0	20.8	0.94	0.75	0.94	31.6
Approach		91	2.3	0.304	44.2	LOS D	3.0	20.8	0.90	0.74	0.90	32.5
West: River Street												
10	L2	56	5.7	0.056	15.7	LOS B	1.2	8.7	0.47	0.67	0.47	43.8
11	T1	1546	3.7	0.682	14.2	LOS A	25.2	181.8	0.72	0.66	0.72	48.7
12	R2	13	0.0	0.115	56.3	LOS D	0.6	4.3	0.97	0.68	0.97	29.8
Approach		1615	3.8	0.682	14.6	LOS B	25.2	181.8	0.72	0.66	0.72	48.3
All Vehicles		2967	4.3	0.682	15.7	LOS B	25.2	181.8	0.69	0.63	0.69	47.4

Site Level of Service (LOS) Method: Delay (RTA NSW). Site LOS Method is specified in the Parameter Settings dialog (Site tab).

Vehicle movement LOS values are based on average delay per movement.

Intersection and Approach LOS values are based on average delay for all vehicle movements.

SIDRA Standard Delay Model is used. Control Delay includes Geometric Delay.

Gap-Acceptance Capacity: SIDRA Standard (Akçelik M3D).

HV (%) values are calculated for All Movement Classes of All Heavy Vehicle Model Designation.

Movement Performance - Pedestrians									
Mov ID	Description	Demand Flow ped/h	Average Delay sec	Level of Service	Average Back of Queue Pedestrian ped	Back of Queue Distance m	Prop. Queued	Effective Stop Rate	
P1	South Full Crossing	53	44.3	LOS E	0.1	0.1	0.94	0.94	
P2	East Full Crossing	53	44.3	LOS E	0.1	0.1	0.94	0.94	
P3	North Full Crossing	53	44.3	LOS E	0.1	0.1	0.94	0.94	
P4	West Full Crossing	53	44.3	LOS E	0.1	0.1	0.94	0.94	
All Pedestrians		211	44.3	LOS E			0.94	0.94	

Level of Service (LOS) Method: SIDRA Pedestrian LOS Method (Based on Average Delay)

Pedestrian movement LOS values are based on average delay per pedestrian movement.

Intersection LOS value for Pedestrians is based on average delay for all pedestrian movements.

MOVEMENT SUMMARY**Site: 101 [River Street / Brunswick Street Option 2 with 2030 traffic (Scenario 5) PM]**

River Street / Brunswick Street Option 2 with 2030 traffic (Scenario 5) PM

Site Category: 1515-1615

Signals - Fixed Time Isolated Cycle Time = 100 seconds (Site User-Given Cycle Time)

Variable Sequence Analysis applied. The results are given for the selected output sequence.

Movement Performance - Vehicles												
Mov ID	Turn	Demand Total veh/h	Flows HV %	Deg. Satn v/c	Average Delay sec	Level of Service	95% Back of Queue Vehicles veh	Distance m	Prop. Queued	Effective Stop Rate	Aver. No. Cycles	Average Speed km/h
South: Brunswick Street												
1	L2	13	8.3	0.026	34.8	LOS C	0.5	3.5	0.78	0.66	0.78	35.1
2	T1	1	0.0	0.234	42.7	LOS D	2.3	15.9	0.93	0.74	0.93	30.5
3	R2	49	0.0	0.234	47.2	LOS D	2.3	15.9	0.93	0.74	0.93	31.9
Approach		63	1.7	0.234	44.6	LOS D	2.3	15.9	0.90	0.72	0.90	32.4
East: River Street												
4	L2	11	0.0	0.683	20.0	LOS B	25.8	185.7	0.73	0.67	0.73	44.6
5	T1	1529	3.5	0.683	14.2	LOS A	25.8	185.7	0.72	0.66	0.72	48.7
6	R2	46	0.0	0.422	58.1	LOS E	2.3	16.4	1.00	0.74	1.00	29.2
Approach		1586	3.4	0.683	15.5	LOS B	25.8	185.7	0.73	0.66	0.73	47.7
North: Brunswick Street												
7	L2	34	3.1	0.071	35.3	LOS C	1.3	9.0	0.79	0.70	0.79	35.1
8	T1	1	0.0	0.296	43.2	LOS D	2.9	20.1	0.94	0.75	0.94	30.4
9	R2	62	0.0	0.296	47.7	LOS D	2.9	20.1	0.94	0.75	0.94	31.7
Approach		97	1.1	0.296	43.3	LOS D	2.9	20.1	0.89	0.73	0.89	32.7
West: River Street												
10	L2	64	1.6	0.062	15.7	LOS B	1.4	9.7	0.47	0.67	0.47	43.9
11	T1	1231	2.8	0.537	12.5	LOS A	17.7	127.0	0.63	0.57	0.63	49.9
12	R2	20	0.0	0.182	56.8	LOS E	1.0	6.9	0.98	0.70	0.98	29.7
Approach		1315	2.7	0.537	13.3	LOS A	17.7	127.0	0.63	0.58	0.63	49.0
All Vehicles		3061	3.0	0.683	16.0	LOS B	25.8	185.7	0.70	0.63	0.70	47.1

Site Level of Service (LOS) Method: Delay (RTA NSW). Site LOS Method is specified in the Parameter Settings dialog (Site tab).

Vehicle movement LOS values are based on average delay per movement.

Intersection and Approach LOS values are based on average delay for all vehicle movements.

SIDRA Standard Delay Model is used. Control Delay includes Geometric Delay.

Gap-Acceptance Capacity: SIDRA Standard (Akçelik M3D).

HV (%) values are calculated for All Movement Classes of All Heavy Vehicle Model Designation.

Movement Performance - Pedestrians									
Mov ID	Description	Demand Flow ped/h	Average Delay sec	Level of Service	Average Back of Queue Pedestrian ped	Distance m	Prop. Queued	Effective Stop Rate	
P1	South Full Crossing	53	44.3	LOS E	0.1	0.1	0.94	0.94	
P2	East Full Crossing	53	44.3	LOS E	0.1	0.1	0.94	0.94	
P3	North Full Crossing	53	44.3	LOS E	0.1	0.1	0.94	0.94	
P4	West Full Crossing	53	44.3	LOS E	0.1	0.1	0.94	0.94	
All Pedestrians		211	44.3	LOS E			0.94	0.94	

Level of Service (LOS) Method: SIDRA Pedestrian LOS Method (Based on Average Delay)

Pedestrian movement LOS values are based on average delay per pedestrian movement.

Intersection LOS value for Pedestrians is based on average delay for all pedestrian movements.



Ardill Payne
& PARTNERS

ENGINEERS PLANNERS SURVEYORS ENVIRONMENTAL PROJECT MANAGEMENT

ROAD SAFETY AUDIT

Existing Road
Byron Bay Road/Byron Street Intersection, Lennox Head

for:



May 2020





BALLINA
45 River Street
PO Box 20
BALLINA NSW 2478
02 6686 3280

GUNNEDAH
Germane House
285 Conadilly Street
GUNNEDAH NSW 2380
02 6742 9955



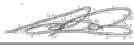

Document Control Sheet

Filename:	10304 2020-05 Byron Bay Rd_Byron St int RSA v0				
Job No.:	10304				
Job Captain:	Tony Cromack				
Author:	Tony Cromack				
Client:	Ballina Shire Council				
File/Pathname	S:\01 Jobs\10300-10399\10304 RSA Byron Bay Rd Byron St, Lennox Head\01 Administration\02 Reports\RSA\10304 2020-05 Byron Bay Rd_Byron St int RSA v0.docx				
Revision No:	Date:	Checked By		Issued By	
		Name	Signed	Name	Signed
0	17.05.20	P. Brouwer		T Cromack	
1	27.05.20	P. Brouwer		T Cromack	
2					

Revision No:	Description
0	Original Issue
1	Revision to suggested improvements
2	



Table of Contents

1.	PROJECT INFORMATION	3
1.1	Introduction	3
1.2	Description of the Site	4
1.3	Traffic and Crash Data	4
1.4	Audit Scope and Objective.....	5
1.5	Audit Team.....	6
2.	ROAD SAFETY AUDIT PROGRAM	7
2.1	Commencement Meeting.....	7
2.2	Field Audit.....	7
2.3	Completion Meeting.....	7
3.	RISK LEVEL DETERMINATION	8
4.	ROAD SAFETY AUDIT FINDINGS	10
5.	CONCLUDING STATEMENT	13
6.	ATTACHMENTS	14

List of Tables

Table 1: Frequency.....	8
Table 2: Severity.....	8
Table 3: Risk	8
Table 4: Treatment.....	9
Table 5: Audit Findings.....	10

1. Project Information

1.1 Introduction

Ballina Shire Council (Council) has engaged Ardill Payne & Partners (APP) to undertake a Road Safety Audit (RSA) of the existing Byron Bay Road/Byron Street intersection at Lennox Head.

The site is shown in the locality plan in **Figure 1**. An aerial photo is shown in **Figure 2**.

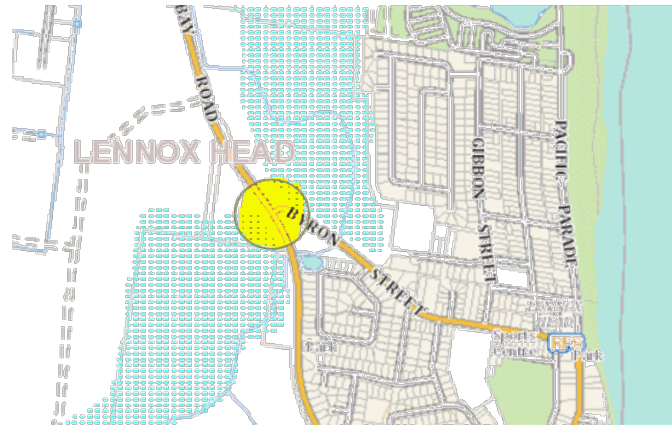

Figure 1: Locality Plan



Figure 2: Aerial Photo

1.2 Description of the Site

Byron Bay Road is a major link in the Ballina Shire arterial road network that together with its southern extension, 'The Coast Road', forms a north-south coastal road link between Ballina in the south and Byron Bay in the north. It passes west of the town of Lennox Head which has two connections – the northern connection at Byron Street (the subject of this audit) and a southern connection at Ballina Street/North Creek Road. To the north of the Byron Street intersection there is a roundabout controlled intersection with Ross Lane which provides access westwards to the Pacific Highway.

The intersection is generally rural in nature (roadside shoulders and table drains). There are channelised right and left turn lanes on Byron Bay Road. Byron Street lanes are median separated, and the intersection is controlled by 'Give Way' signs. All lanes are sealed and line marked. Byron Bay Road has an 80 kph speed limit and Byron Street has a 50 kph urban default speed limit.

Council has advised as follows:

"Observations of traffic behavior at the intersection over a number of years have identified substantial queuing on the Byron Street leg, particularly in the AM peak. The majority of queued vehicles have been observed indicating right turn intentions with a minority indicating left turn intentions. During the AM peak the traffic volumes in both directions on Byron Bay Road are high and the Byron Street queuing is an indication of insufficient gaps being available for traffic turning right from Byron Street. The left turn from Byron Street is far less inhibited in terms of safe gaps in traffic, however left turning vehicles are often trapped behind right turning vehicles. It has also been observed that a portion of right turning vehicles from Byron Street make this manoeuvre when there is insufficient gap to do so safely. It is presumed this is to some extent caused by driver frustration with queue delay times and inability to identify timely occurrence of safe gaps in the Byron Bay Road traffic stream".

Site photographs are provided in **Attachment 1**.

Some key physical and observed features of the intersection and approach roads are:

- Sight distance is adequate in both directions, but can be obstructed during peak periods by vehicle congestion and turning vehicles.
- Lack of advance warning of the intersection.
- Angle of Byron Street approach.
- Narrow lane Byron Street eastbound (constricted by safety barrier and median)
- Setback of hold line in Byron Street.

1.3 Traffic and Crash Data

Council has provided the following traffic volume data for the roads:

- Traffic counts in June 2019 indicated 10,165 vpd on Byron Bay Road, 200m south of Ross Lane. Traffic modelling for the year 2036 predicts 16,709 vpd between Byron Street and Ross Lane and 8,650 vpd south of Byron Street.
- The nearest traffic count to the subject intersection on Byron Street was in April 2019, 15m west of Park Lane and indicated 5,897 vpd. However, traffic modelling indicates that only 75% of this volume would persist to the Byron Street leg of the Byron Bay Road intersection. Traffic modelling for the year 2036 predicts 8,395 vpd on the Byron Street leg of the subject intersection.

Council has provided the following crash data for the site:

Accident ID	Date	Degree of Crash	Time	RUM Code	Turn Direction 1	Turn Manoeuvre 1	Turn Direction 2	Turn Manoeuvre 2
1176870	15/7/18	Minor/Other Injury	1630	21 (Right through)	North	Turn right	South	Proceed in lane
1041299	28/7/14	Moderate Injury	1535	13 (Right near)	West	Right turn	North	Proceed in lane

- There have been no recorded fatalities.
- Both crashes occurred in the PM peak.

Note: traffic and crash data was not reviewed until after the RSA findings were documented.

1.4 Audit Scope and Objective

This report is a Road Safety Audit of the existing intersection at Byron Bay Road/Byron Street, Lennox Head.

The scope of the RSA has been limited to assessment of the intersection from the perspective of all road users, and during daylight and night conditions.

The objective of the RSA is to identify any potential road safety issues/deficiencies associated with the existing arrangement from the perspective of all road users that may need to be investigated and rectified. Deficiencies raised will be described and given a risk rating. Positive aspects of the road environment have not been recorded.

The RSA has been carried out in accordance with the prescribed methods in the Austroads 'Guide to Road Safety, Part 6A: Implementing Road Safety Audits' (2019), with consideration of the NSW RMS 'Guidelines for Road Safety Audit Practices, Part 1: Road Safety Audit' (2011).

The RMS Guide does not permit the inclusion of recommendations in a RSA. However, the Austroads Guide does permit the inclusion of recommendations, if requested by the client. We have included a supplement to the RSA documenting our suggested improvement options to improve road safety to enable Council to make informed decisions for future upgrade works. The suggested improvement options indicate the nature or direction of a solution rather than precise details. Responsibility for that will rest with Council.



1.5 Audit Team

The RSE has been carried out by Tony Cromack and Peter Brouwer (APP). Tony Cromack is the lead auditor.

Lead Auditor – Tony Cromack

- Senior Civil Engineer and Principal at Ardill Payne & Partners, with over 35 years' experience in urban and rural road design
- Bachelor of Technology (Engineering), University of Southern Queensland, (1999)
- Technologist Member – Engineers Australia
- Member – Institute of Public Works Engineering Australasia (IPWEA)
- NSW RMS accreditation to Prepare Work Zone Traffic Management Plans (2020)
- 'Road Safety Auditor' course, IPWEA (2014)
- 'Lead Road Safety Auditor' course, IPWEA (2017)
- 'Safe System Principles' and 'Safe System Assessments' courses, Safe System Solutions Pty Ltd, Victoria (2019)
- 'Treatment of Crash Locations' course, IPWEAQ (2019)
- Registered Level 3 Road Safety Auditor (NSW) – Auditor # RSA-02-0414

Auditor – Peter Brouwer

- Senior Civil Designer at Ardill Payne & Partners, with over 30 years' experience in urban and rural road design
- Associate Diploma in Surveying – Queensland Institute of Technology (1985)
- Autocad Drafting Certificate – TAFE (1999)
- 'Road Safety Auditor' course, IPWEA (2018.)
- Registered Level 1 Road Safety Auditor (NSW) – Auditor # RSA-02-1325



2. Road Safety Audit Program

2.1 Commencement Meeting

The commencement meeting was held via teleconference on 12 May 2020. Patrick Knight represented Council and Tony Cromack represented the audit team.

A summary of the meeting is as follows:

- Mr. Knight confirmed that the purpose of the audit is to inform future upgrade designs for the intersection, and to possibly assist in future funding applications.
- There are no known previous road safety audits for these sites.
- There are no specific environmental issues affecting the road.
- Further detail and specifics of any Council concerns were not raised or discussed to ensure the audit team could undertake an unbiased RSA.
- Mr. Cromack explained the audit process, reiterating that it is not a compliance or design check, and advised that recommendations are only provided if requested. Mr. Knight requested that recommendations for improvements identified by the team be provided. General comments and suggested improvement options will be included as a supplement to the final report.
- Mr. Knight was advised that it is the audit teams task to identify and document safety issues, and Council's task to respond and act on those issues
- Council has provided road traffic volume and crash data.

2.2 Field Audit

The field audit was carried out by the audit team on the afternoon and evening of Wednesday 13 May 2020. The team drove through the site twice in each direction and filmed the drive from the dashboard of the vehicle.

The daylight audit took place between 4:00 and 4:45pm (AEST), and the evening audit between 10:00 and 10:30pm.

The weather on the day was overcast. There had been 5mm of rain in the previous 24 hours. The road surface at time of inspection was dry.

Photographs of any deficiencies found were taken and notes were made.

2.3 Completion Meeting

A completion meeting generally involves the auditor and the client, and is an opportunity for clarification of aspects of the audit. A completion meeting has not been held at the time of preparing this report.

3. Risk Level Determination

Deficiencies raised in relation to the audit have been given a risk level based on the associated safety priority, as categorised using **Table 1** to **Table 4**. The risk tables below are reproduced from Austroads 'Guide to Road Safety Part 6A: Implementing Road Safety Audits' (2019).

Table 1: Frequency

Frequency	Description
Frequent	Once or more per week
Probable	Once or more per year (but less than once a week)
Occasional	Once every five to ten years
Improbable	Less often than once every ten years

Table 2: Severity

Severity	Description	Examples
Catastrophic	Likely multiple deaths	<ul style="list-style-type: none"> ▪ High-speed multi-vehicle crash on a freeway ▪ Car runs into crowded bus stop ▪ Bus and petrol tanker collide ▪ Collapse of a bridge or tunnel
Serious	Likely death or serious injury	<ul style="list-style-type: none"> ▪ High/medium speed two-vehicle collision ▪ High/medium speed collision with fixed roadside object ▪ Pedestrian/cyclist struck by a car
Minor	Likely minor injury	<ul style="list-style-type: none"> ▪ Some low speed vehicle collisions ▪ Cyclist falls from bike at low speed ▪ Left turn rear-end collision in a slip lane
Limited	Likely trivial injury or property damage only	<ul style="list-style-type: none"> ▪ Some low speed vehicle collisions ▪ Pedestrian walks into object (no head injury) ▪ Car reverses into a post

Table 3: Risk

Severity	Frequency			
	Frequent	Probable	Occasional	Improbable
Catastrophic	Intolerable	Intolerable	Intolerable	High
Serious	Intolerable	Intolerable	High	Medium
Minor	Intolerable	High	Medium	Low
Limited	High	Medium	Low	Low



Table 4: Treatment

Risk	Suggested Treatment Approach
Intolerable	Must be corrected
High	Should be corrected or the risk significantly reduced, even if the treatment cost is high.
Medium	Should be corrected or the risk significantly reduced, if the treatment cost is moderate, but not high.
Low	Should be corrected or the risk reduced, if the treatment cost is low.

4. Road Safety Audit Findings

The following audit findings were identified during the RSA inspection. Audit findings are a listing of identified safety deficiencies: what is potentially dangerous about the road or what could lead to crashes occurring or injury resulting. Relevant photographs of the findings are provided in **Attachment 1**.

Table 5: Audit Findings

Number	Description	Risk Rating
01	<p>Limited Advance Warning of Intersection</p> <p>There are no 'Side Road Intersection' signs in either approach on Byron Bay Road. However, there are green guide signs near the intersection in both approaches.</p> <p>There is a risk that drivers may not have sufficient advance warning of the intersection, resulting in confusion at the intersection and increased risk of a crash.</p> <p><i>Location: Both approaches in Byron Bay Road</i></p>	<p>Frequency: Improbable</p> <p>Severity: Serious</p> <p>Risk: Medium</p>
02	<p>Poor Condition of Line Marking</p> <p>The painted lines and chevrons in the intersection are badly worn in places.</p> <p>Without adequate delineation, there is a risk that drivers will be confused at the intersection, increasing the risk of a crash when changing lanes.</p> <p><i>Refer to Photo No. 01</i></p> <p><i>Location: Intersection</i></p>	<p>Frequency: Improbable</p> <p>Severity: Minor</p> <p>Risk: Low</p>
03	<p>Sight Distances</p> <p>The physical sight distances are adequate, however sight distance, especially looking north from the intersection, can be obstructed by turning vehicles.</p> <p>There is a risk that a driver may not see through traffic behind turning vehicles, and pull out in front of a through travelling vehicle.</p> <p><i>Refer to Photo No. 02</i></p> <p><i>Location: Looking north from intersection</i></p>	<p>Frequency: Occasional</p> <p>Severity: Serious</p> <p>Risk: High</p>

04	<p>Change to 50 Speed Zone in Byron Street</p> <p>Change in speed zone in Byron Street – the ‘50’ pavement marking is barely visible.</p> <p>There is a risk that a driver may not perceive the change in speed zone. Drivers may not reduce speed, which may increase the severity of a crash.</p> <p><i>Refer to Photo No. 03</i></p> <p><i>Location: Byron Street</i></p>	<p>Frequency: Improbable</p> <p>Severity: Serious</p> <p>Risk: Medium</p>
05	<p>Visibility of Median in Byron Street</p> <p>The concrete median is not well contrasted to the bitumen road surface. The kerb edges are not painted white.</p> <p>There is a risk that vehicle could impact the median and the driver lose control, resulting in a collision with a roadside hazard or another vehicle.</p> <p><i>Refer to Photo No. 04</i></p> <p><i>Location: Byron Street</i></p>	<p>Frequency: Improbable</p> <p>Severity: Serious</p> <p>Risk: Medium</p>
06	<p>Location of Hold Line</p> <p>The give way hold line is set well back from the intersection. Drivers sight lines are adversely impacted (obstruction by turning vehicles worsened), and the time to accelerate into gaps in the through traffic is increased.</p> <p>There is a risk that a driver may not see through traffic behind turning vehicles, and pull out in front of a through travelling vehicle.</p> <p><i>Refer to Photo No. 05</i></p> <p><i>Location: Intersection</i></p>	<p>Frequency: Occasional</p> <p>Severity: Serious</p> <p>Risk: High</p>
07	<p>Lack of Facilities for Pedestrians</p> <p>There are no facilities (pedestrian refuge or similar) for pedestrians to cross Byron Street at the intersection. There is also no width (shoulder or verge) on the northern side of Byron Street to provide a safe path for pedestrians. Any pedestrians on Byron Street would have to walk on the southern side, and cross at the intersection to head north.</p> <p>Without adequate pedestrian facilities, pedestrians may cross the road randomly, increasing the risk of being struck by a vehicle.</p> <p><i>Refer to Photo No. 06</i></p> <p><i>Location: Byron Street</i></p>	<p>Frequency: Improbable</p> <p>Severity: Serious</p> <p>Risk: Medium</p>



<p>08</p>	<p>Narrow Eastbound Lane Byron Street</p> <p>The width of the eastbound lane of Byron Street from the intersection east for approx. 80m is constrained by the safety barrier on the left and the median on the right.</p> <p>There is a risk that a cyclist on this section of the road could be struck from behind by a vehicle.</p> <p><i>Refer to Photo No. 06</i></p> <p><i>Location: Byron Street, eastbound lane</i></p>	<p>Frequency: Improbable</p> <p>Severity: Serious</p> <p>Risk: Medium</p>
<p>09</p>	<p>Traffic Volume and Speed on Byron Bay Road</p> <p>Traffic volumes on Byron Bay Road during peak periods are high. During the site inspection, a high proportion of traffic was observed turning left into and right out of Byron Street. The speed of some through vehicles on Byron Bay Road appeared excessive.</p> <p>There is an increased exposure to crashes due to the traffic volumes. There is a risk that the severity of a crash could be increased due to the excessive speed.</p>	<p>Frequency: Improbable</p> <p>Severity: Serious</p> <p>Risk: Medium</p>



5. Concluding Statement

We, the audit team, declare that we are independent of the project and have appropriate experience and training.

The audit has been carried out for the sole purpose of identifying any features of the intersection which could compromise road safety at the site. The identified issues have been noted in this report in **Table 5**. The accompanying 'General Comments and Suggested Improvement Options' (**Attachment 2**) are put forward for consideration by Council for implementation. The suggested improvement options indicate the nature or direction of a solution rather than precise details. Responsibility for that will rest with Council. APP does not take any responsibility for any suggested design changes made in this report.

It should be noted that while every effort has been made to identify potential safety hazards, there is no guarantee that every deficiency has been identified.

No 'intolerable' risks were identified during the audit. As per **Table 4**, risks with a 'high' ranking '*should be corrected or the risk significantly reduced, even if the treatment cost is high*'. Risks with a 'medium' ranking '*should be corrected or the risk significantly reduced, if the treatment cost is moderate, but not high*'.

It is recommended that audit findings be investigated with satisfactory corrective actions identified and implemented.

A handwritten signature in black ink, appearing to read 'T. Cromack'.

19/05/2020

Tony Cromack
AUDIT TEAM LEADER # RSA-02-0414

A handwritten signature in black ink, appearing to read 'P. Brouwer'.

19/05/2020

Peter Brouwer
AUDIT TEAM MEMBER # RSA-02-1325



6. Attachments

- Attachment 1 Site Photographs
- Attachment 2 General Comments and Suggested Improvement Options



ATTACHMENT 1

Attachment 1: Site Photographs



Photo No. 1: Condition of line marking

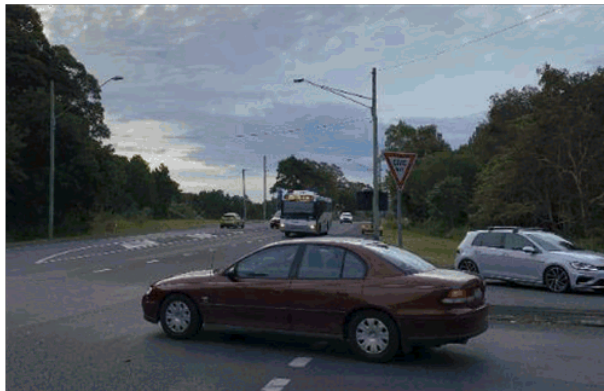

Photo No. 2: Sight distance to the north with turning vehicle (note through vehicle beside rear of bus)



Photo No. 3: Condition of pavement marking at 50 zone



Photo No. 4: Lack of visibility of median – Byron Street



Photo No. 5: Location of hold line, set well back from through lane



Photo No. 6: Narrow eastbound lane – Byron Street



Photo 7: Intersection is well lit



ATTACHMENT 2

Attachment 2: General Comments and Suggested Improvement Options

General Comments and Suggested Improvement Options

Following is a list of general comments and suggested improvement options which may be of some use to Council. It should be noted that while every effort has been made to identify potential safety hazards, there is no guarantee that every safety hazard has been identified, therefore the list of general comments and suggested improvement options may not be exhaustive.

The suggested improvement options indicate the nature or direction of a solution rather than precise details. Responsibility for that will rest with Council.

The general comments and suggested improvement options do not take into consideration future project budgets, community objectives, project constraints, political agendas, or possible competing interests from other project needs (e.g. landscaping, utilities, etc.).

The following comments relate to the existing intersection:

- Provide advance warning signs ('Side Road Intersection' or similar) in both approaches on Byron Bay Road.
- To improve intersection delineation, repaint intersection line-marking. This should include painting the median kerbs in Byron Street. Replace retro-reflective pavement markers as required.
- Repaint '50' road pavement marking at change of speed zone in Byron Street.
- Consider extending the centre median in Byron Street and moving the hold line west. This would improve sight lines for drivers exiting Byron Street and reduce time to enter through traffic stream.
- Consider providing a pedestrian refuge in the centre median in Byron Street. This would require widening of the median at that location, and provision of appropriate advance warning signs.
- Consider relocating the safety barrier on the northern side of Byron Street to provide a wider clearance between edge of lane and safety barrier.
- Consider removing the left turn lane into Byron Street and changing it to a short taper. This may remove the hazard that results from drivers in Byron Street not seeing through vehicles on Byron Bay Road passing outside of left turning vehicles. Consideration of this option may require an intersection analysis.

The following comments should be considered in any future redesigns of the intersection:

- Consider replacing the intersection with a roundabout. This would reduce speeds at the intersection and reduce exposure to serious crashes. This may require a detailed traffic analysis of the intersection.
- Consider widening Byron Street to provide both a dedicated left turn and right turn lane. This would reduce delays at the intersection, particularly for left turning vehicles.
- Consider providing a left turn slip lane in Byron Bay Road for vehicles turning left into Lennox Head (into Byron Street). This would provide separation between turning and through traffic and improve sight lines for drivers exiting Byron Street.

7.2 Byron Bay Road/Byron Street Intersection, Lennox Head



- Consider providing an acceleration lane for left turning vehicles out of Byron Street.
- Consider reducing the speed limit on Byron Bay Road past the intersection.



Ardill Payne
& PARTNERS

ENGINEERS PLANNERS SURVEYORS ENVIRONMENTAL PROJECT MANAGEMENT

SAFE SYSTEM ASSESSMENT

Existing Road and Concept Design
Byron Bay Road/Byron Street Intersection, Lennox Head

for:



May 2020

BALLINA
45 River Street
PO Box 20
BALLINA NSW 2478
02 6686 3280

GUNNEDAH
Germane House
285 Conadilly Street
GUNNEDAH NSW 2380
02 6742 9955





Document Control Sheet

Filename:	10304 2020-05 Byron Bay Rd_Byron St int SSA v0
Job No.:	10304
Job Captain:	Tony Cromack
Author:	Tony Cromack
Client:	Ballina Shire Council
File/Pathname	S:\01 Jobs\10300-10399\10304 RSA Byron Bay Rd Byron St, Lennox Head\01 Administration\02 Reports\SSA\10304 2020-05 Byron Bay Rd_Byron St int SSA v0.docx

Revision No:	Date:	Checked By		Issued By	
		Name	Signed	Name	Signed
0	25.05.20	P. Brouwer		T Cromack	
1	27.05.20	P. Brouwer		T Cromack	
2					

Revision No:	Description
0	Original Issue
1	Amendment to 'Summary and Conclusions'
2	



Table of Contents

1.	THE SAFE SYSTEM APPROACH.....	4
1.1	Safe System Pillars.....	4
1.2	Safe System Impact Speeds.....	5
2.	ASSESSMENT DETAILS	5
2.1	Assessment Team.....	5
2.2	Meetings and Site Inspections	6
3.	PROJECT CONTEXT AND DESCRIPTION.....	7
3.1	Existing Conditions and Project Background	7
3.2	Proposed Works.....	8
4.	SAFE SYSTEM ASSESSMENT	11
4.1	Assessment Approach.....	11
4.2	Safe System Assessment Matrices	12
5.	TREATMENTS TO IMPROVE SAFE SYSTEM ALIGNMENT	16
6.	ADDITIONAL SAFE SYSTEM COMPONENTS	16
7.	SUMMARY AND CONCLUSIONS.....	17
8.	ATTACHMENTS	19

List of Tables

Table 1: Project Context.....	10
Table 2: SSA Matrix – Existing Conditions.....	12
Table 3: SSA Matrix – Concept Design	14
Table 4: Primary Treatments	16
Table 5: Supporting Treatments	16
Table 6: Other Safe System Components	17

1. The Safe System Approach

1.1 Safe System Pillars

The Safe System approach seeks to ensure that no road user is subjected to kinetic energy exchange in a crash that will result in death or serious injury. There is a shared responsibility for safe travel outcomes between system designers (road authorities, vehicle manufactures, road designers etc.) and road users. There are four Safe System pillars:

- safer vehicles
- safer speeds
- safer roads, and
- safer road users.

Post-crash response is another element that is often recognised as the fifth pillar. All parts of the system must be considered and strengthened so that road safety outcomes are maximised and to ensure that road users are adequately protected even if one part fails.

A Safe System Assessment (SSA) is concerned mainly with the safer roads and safer speeds pillars. A SSA is used to examine road project proposals and aims to identify infrastructure and speed related factors that are likely to contribute to a higher risk of fatal and serious injury (FSI) crashes. It also seeks to identify design or scope changes that will improve the alignment of the project with Safe System principles.

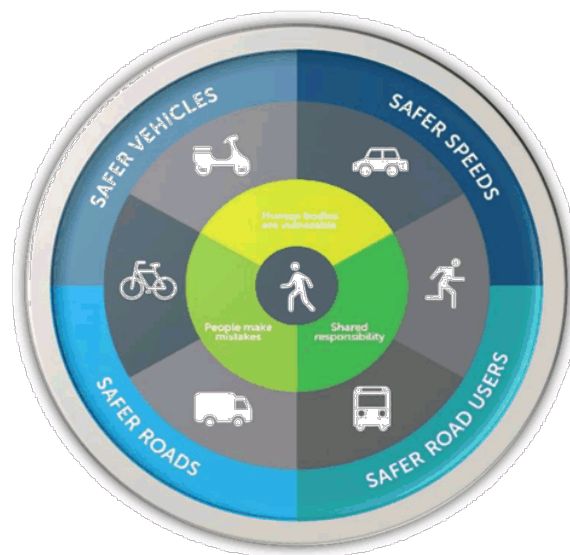

Figure 1: Safe System Pillars

1.2 Safe System Impact Speeds

The impact speed in a collision is a significant factor that affects the probability of a person being killed or seriously injured in a crash. Safe System impact speeds are speeds below which the chances of survival are high and the likelihood of serious injury is low.

Figure 2 is a guide to Safe System impact speeds for common crash types. It should be noted that the angle of impact of a collision is also a factor that affects the severity of a crash. As far as is practically possible, infrastructure should be designed and travel speeds managed so that the impact speeds when a crash occurs are below the thresholds show in **Figure 2**.





CRASH TYPE	IMPACT SPEED
 Head on with another vehicle	70 km/h
 Side impact	50 km/h
 Side impact with tree	30 km/h
 Pedestrian & cyclists	30 km/h

Figure 2: Safe System Impact Speeds

2. Assessment Details

2.1 Assessment Team

The SSA has been carried out by Tony Cromack and Peter Brouwer (APP). Tony Cromack is the lead auditor.

Lead Auditor – Tony Cromack

- Senior Civil Engineer and Principal at Ardill Payne & Partners, with over 35 years' experience in urban and rural road design
- Bachelor of Technology (Engineering), University of Southern Queensland, (1999)
- Technologist Member – Engineers Australia
- Member – Institute of Public Works Engineering Australasia (IPWEA)
- NSW RMS accreditation to Prepare Work Zone Traffic Management Plans (2020)



- 'Road Safety Auditor' course, IPWEA (2014)
- 'Lead Road Safety Auditor' course, IPWEA (2017)
- 'Safe System Principles' and 'Safe System Assessments' courses, Safe System Solutions Pty Ltd, Victoria (2019)
- 'Treatment of Crash Locations' course, IPWEAQ (2019)
- Registered Level 3 Road Safety Auditor (NSW) – Auditor # RSA-02-0414

Auditor – Peter Brouwer

- Senior Civil Designer at Ardill Payne & Partners, with over 30 years' experience in urban and rural road design
- Associate Diploma in Surveying – Queensland Institute of Technology (1985)
- Autocad Drafting Certificate – TAFE (1999)
- 'Road Safety Auditor' course, IPWEA (2018.)
- Registered Level 1 Road Safety Auditor (NSW) – Auditor # RSA-02-1325

2.2 Meetings and Site Inspections

A pre-commencement meeting was held via teleconference on 12 May 2020. Patrick Knight represented Council and Tony Cromack represented the audit team.

A site inspection was carried out by the audit team on the afternoon and evening of Wednesday 13 May 2020. The team drove through the site twice in each direction and filmed the drive from the dashboard of the vehicle. Site photographs are provided in **Attachment 1**.

The daylight audit took place between 4:00 and 4:45pm (AEST), and the evening audit between 10:00 and 10:30pm.

The weather on the day was overcast. There had been 5mm of rain in the previous 24 hours. The road surface at time of inspection was dry.

A completion meeting generally involves the auditor and the client, and is an opportunity for clarification of aspects of the assessment. A completion meeting has not been held at the time of preparing this report.

3. Project Context and Description

3.1 Existing Conditions and Project Background

Byron Bay Road is a major link in the Ballina Shire arterial road network that together with its southern extension, 'The Coast Road', forms a north-south coastal road link between Ballina in the south and Byron Bay in the north. It passes west of the town of Lennox Head which has two connections – the northern connection at Byron Street (the subject of this audit) and a southern connection at Ballina Street/North Creek Road. To the north of the Byron Street intersection there is a roundabout controlled intersection with Ross Lane which provides access westwards to the Pacific Highway.

The intersection is generally rural in nature (roadside shoulders and table drains). There are channelised right and left turn lanes on Byron Bay Road. Byron Street lanes are median separated, and the intersection is controlled by 'Give Way' signs. All lanes are sealed and line marked. Byron Bay Road has an 80 kph speed limit and Byron Street has a 50 kph urban default speed limit.

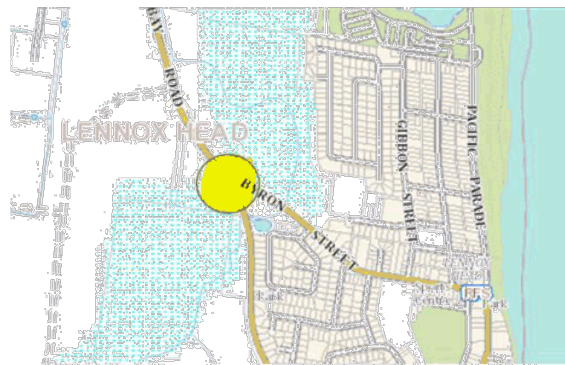

Figure 3: Locality Plan

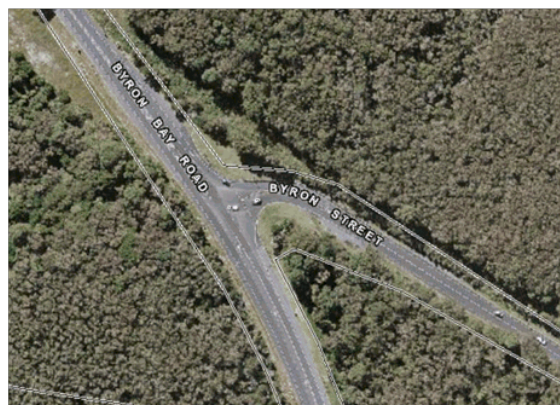

Figure 4: Aerial Photo

Council has advised as follows:

“Observations of traffic behaviour at the intersection over a number of years have identified substantial queuing on the Byron Street leg, particularly in the AM peak. The majority of queued vehicles have been observed indicating right turn intentions with a minority indicating left turn intentions. During the AM peak the traffic volumes in both directions on Byron Bay Road are high and the Byron Street queuing is an indication of insufficient gaps being available for traffic turning right from Byron Street. The left turn from Byron Street is far less inhibited in terms of safe gaps in traffic, however left turning vehicles are often trapped behind right turning vehicles. It has also been observed that a portion of right turning vehicles from Byron Street make this manoeuvre when there is insufficient gap to do so safely. It is presumed this is to some extent caused by driver frustration with queue delay times and inability to identify timely occurrence of safe gaps in the Byron Bay Road traffic stream”.

Council has provided the following traffic volume data for the roads:

- Traffic counts in June 2019 indicated 10,165 vpd on Byron Bay Road, 200m south of Ross Lane. Traffic modelling for the year 2036 predicts 16,709 vpd between Byron Street and Ross Lane and 8,650 vpd south of Byron Street. Heavy vehicles approx. 8%; motorcycles approx. 0.5%.
- The nearest traffic count to the subject intersection on Byron Street was in April 2019, 15m west of Park Lane and indicated 5,897 vpd. However, traffic modelling indicates that only 75% of this volume would persist to the Byron Street leg of the Byron Bay Road intersection. Traffic modelling for the year 2036 predicts 8,395 vpd on the Byron Street leg of the subject intersection.

Council has provided the following crash data for the site for the period 2014–2019:

- Two recorded crashes, one resulting in a moderate injury, and one resulting in a minor injury.
- There have been no recorded fatalities.
- Both were two vehicle collisions at the intersection.
- Both crashes occurred in the PM peak.

3.2 Proposed Works

Observations of traffic behaviour at the intersection over a number of years have identified substantial queuing on the Byron Street leg, particularly in the AM peak. The majority of queued vehicles have been observed indicating right turn intentions with a minority indicating left turn intentions. During the AM peak the traffic volumes in both directions on Byron Bay Road are high and the Byron Street queuing is an indication of insufficient gaps being available for traffic turning right from Byron Street. The left turn

from Byron Street is far less inhibited in terms of safe gaps in traffic, however left turning vehicles are often trapped behind right turning vehicles. It has also been observed that a portion of right turning vehicles from Byron Street make this manoeuvre when there is insufficient gap to do so safely. It is presumed this is to some extent caused by driver frustration with queue delay times and inability to identify timely occurrence of safe gaps in the Byron Bay Road traffic stream.

To assist in alleviating this situation, it is proposed to construct the low cost modification shown in **Figure 5**. The concept design provides for separate left and right turn lanes in the Byron Street approach leg. It also proposes to move the hold line forward (with associated extension of painted median) to provide improved sight distance for right turning vehicles. It is anticipated this modified layout will enable relatively free flow for left turning vehicles, reduce queue lengths and delays for right turning vehicles and reduce driver frustration.



Figure 5: Concept Design

Table 1: Project Context

Prompts	Comments
What is the reason for the project ? Is there specific crash type risk? Is it addressing specific issues such as poor speed limit compliance, road access, congestion, future traffic growth, freight movement, amenity concerns from the community, maintenance/asset renewal, etc.	<ul style="list-style-type: none"> • Number of crashes at the intersection • Significant delays during peak periods • Sight distance • Community concerns • Has become a media issue • Increased traffic due to development • To assess the level of improvement in Safe System when comparing the existing intersection to the concept design
What is the function of the road? Consider location, roadside land use, area type, speed limit, intersection type, presence of parking, public transport services and vehicle flows. What traffic features exist nearby (e.g. upstream and downstream)? What alternative routes exist?	<ul style="list-style-type: none"> • Arterial (Byron Bay Rd) • Both roads are bus routes (no bus stops nearby) • Channelised T-intersection (Give Way) • Access to coastal tourist town
What is the speed environment? What is the current speed limit? Has it changed recently? Is it similar to other roads of this type? How does it compare to Safe System speeds? What is the acceptability of lowering the speed limit at this location?	<ul style="list-style-type: none"> • Byron Bay Road 80kph, Byron St 50kph
What road users are present? Consider the presence of elderly pedestrians, school children and cyclists. Also note what facilities are available to vulnerable road users (e.g. signalised crossings, bicycle lanes, school speed limits, etc.)	<ul style="list-style-type: none"> • Commuters to/from Byron Bay • School buses • Tourists • Recreational cyclists • Low pedestrian volume (no pedestrian refuge provided)
What is the vehicle composition? Consider the presence of heavy vehicles (and what type), motorcyclists and other vehicles using the roadway.	<ul style="list-style-type: none"> • Approx. 8% HV (typically construction vehicles and buses)



4. Safe System Assessment

This Safe System Assessment is based on Austroads 'Safe System Assessment Framework' (Austroads 2016, Research Report AP-R509-16).

4.1 Assessment Approach

Each cell in the matrix (in **Table 2** and **Table 3**) is assigned a score between 0 and 4. A score of 0 indicates that the system is fully aligned with the Safe System vision for that component of a given crash type. The higher the score, the further the project is from a Safe System condition. Scores are allocated considering the factors of interest shown in Table 4.2 of Austroads AP-R509-16, and the scoring system shown in Table 4.4 of Austroads AP-R509-16. It should be noted that some elements can be included in either crash likelihood or severity, as they may affect both in a given situation.

Comments are added to each of the cells to help identify the specific issues of concern.

Once scores are allocated for each cell, the product of each column is calculated and entered in the final row, labelled 'total'. If a score of zero has been given for any component of a crash type (i.e. exposure, likelihood or severity), that crash type receives a total of zero and is eliminated from the score (as it has reached a Safe System). The sum of the infrastructure total scores for each crash type is then added to the final cell in the bottom right corner. This score is out of a possible 448 and represents the safer speeds and safer roads and roadsides pillars. The closer the score is to zero, the more the project in question is in alignment with Safe System principles.



4.2 Safe System Assessment Matrices

Table 2: SSA Matrix – Existing Conditions

	Run-off road	Head-on	Intersection	Other	Pedestrian	Cyclist	Motorcyclists
Exposure Comments:	<ul style="list-style-type: none"> High volume (>10,000 vpd on Byron Bay Rd) ✘ 	<ul style="list-style-type: none"> High volume (>10,000 vpd on Byron Bay Rd) ✘ 	<ul style="list-style-type: none"> High volumes (>10,000 vpd on Byron Bay Rd, >5,000 vpd on Byron St) ✘ 	<ul style="list-style-type: none"> High volume (>10,000 vpd on Byron Bay Rd) ✘ 	<ul style="list-style-type: none"> Low pedestrian volume ✓ 	<ul style="list-style-type: none"> Low cyclist volume ✓ 	<ul style="list-style-type: none"> High volumes (>10,000 vpd on Byron Bay Rd, >5,000 vpd on Byron St) ✘ M/C volume (>50 per day) ✘
Exposure Score:	4/4	4/4	4/4	4/4	1/4	2/4	3/4
Likelihood Comments:	<ul style="list-style-type: none"> Speed ✘ Entering traffic ✘ No barriers ✘ Wide shoulders ✓ 	<ul style="list-style-type: none"> Speed ✘ Entering traffic ✘ High % rt turns ✘ 	<ul style="list-style-type: none"> Speed ✘ Sight distance (obstructed by turning veh.) ✘ High % rt turns ✘ Location of hold line ✘ Frustration due to delays ✘ Minimal advance warning ✘ Dedicated turn lanes BB Rd ✓ Lighting ✓ Median in Byron Street ✓ 	<ul style="list-style-type: none"> Short acceleration lane ✘ Buses and HV impacting sight distance ✘ 	<ul style="list-style-type: none"> Speed ✘ Crossing length ✘ No pedestrian refuge ✘ No pedestrian path ✘ 	<ul style="list-style-type: none"> Speed ✘ Narrow lane Byron St ✘ Recreational cyclists ✘ No cycle lane or path ✘ No crossing facilities ✘ 	<ul style="list-style-type: none"> Speed ✘ Sight distance (obstructed by turning veh.) ✘ High % rt turns ✘ Location of hold line ✘ Frustration due to delays ✘ Minimal advance warning ✘ Dedicated turn lanes BB Rd ✓ Lighting ✓ Median in Byron Street ✓
Likelihood Score:	2/4	3/4	4/4	2/4	2/4	2/4	3/4

7.2 Byron Bay Road/Byron Street Intersection, Lennox Head



Severity Comments:	<ul style="list-style-type: none"> • Speed ✘ • No barriers ✘ • Roadside hazards (poles/trees) ✘ • Wide run off area ✓ 	<ul style="list-style-type: none"> • Speed ✘ 	<ul style="list-style-type: none"> • High speed on Byron Bay Rd ✘ • Low speed in Byron St ✓ 	<ul style="list-style-type: none"> • Speed ✘ 	<ul style="list-style-type: none"> • Speed ✘ • No pedestrian refuge ✘ 	<ul style="list-style-type: none"> • Speed ✘ • No crossing facilities ✘ 	<ul style="list-style-type: none"> • Speed ✘ • No barriers ✘ • Roadside hazards (poles/trees) ✘
Severity Score:	2/4	3/4	4/4	3/4	4/4	4/4	4/4
Product (multiply scores)	16/64	36/64	64/64	24/64	8/64	16/64	36/64
TOTAL							200/448



Table 3: SSA Matrix – Concept Design

	Run-off road	Head-on	Intersection	Other	Pedestrian	Cyclist	Motorcyclists
Exposure Comments:	<ul style="list-style-type: none"> High volume (>10,000 vpd on Byron Bay Rd) ✘ 	<ul style="list-style-type: none"> High volume (>10,000 vpd on Byron Bay Rd) ✘ 	<ul style="list-style-type: none"> High volumes (>10,000 vpd on Byron Bay Rd, >5,000 vpd on Byron St) ✘ 	<ul style="list-style-type: none"> High volume (>10,000 vpd on Byron Bay Rd) ✘ 	<ul style="list-style-type: none"> Low pedestrian volume ✓ 	<ul style="list-style-type: none"> Low cyclist volume ✓ 	<ul style="list-style-type: none"> High volumes (>10,000 vpd on Byron Bay Rd, >5,000 vpd on Byron St) ✘ M/C volume (>50 per day) ✘
Exposure Score:	4/4	4/4	4/4	4/4	1/4	2/4	3/4
Likelihood Comments:	<ul style="list-style-type: none"> Speed ✘ Entering traffic ✘ No barriers ✘ Wide shoulders ✓ 	<ul style="list-style-type: none"> Speed ✘ Entering traffic ✘ High % rt turns ✘ 	<ul style="list-style-type: none"> Speed ✘ Sight distance improved, but still obstructed by turning vehicles ✘ High % rt turns ✘ Location of hold line ✓ Delays reduced ✓ Minimal advance warning ✘ Dedicated turn lanes BB Rd ✓ Lighting ✓ Median in Byron Street ✓ 	<ul style="list-style-type: none"> Short acceleration lane ✘ Sight distance improved, but still obstructed by turning vehicles ✘ 	<ul style="list-style-type: none"> Speed ✘ Crossing length increased ✘ No pedestrian refuge ✘ No pedestrian path ✘ 	<ul style="list-style-type: none"> Speed ✘ Narrow lane Byron St ✘ Recreational cyclists ✘ No cycle lane or path ✘ No crossing facilities ✘ 	<ul style="list-style-type: none"> Speed ✘ Sight distance improved, but still obstructed by turning vehicles ✘ High % rt turns ✘ Location of hold line ✓ Delays reduced ✓ Minimal advance warning ✘ Dedicated turn lanes BB Rd ✓ Lighting ✓ Median in Byron Street ✓
Likelihood Score:	2/4	3/4	3/4	2/4	2/4	2/4	3/4

7.2 Byron Bay Road/Byron Street Intersection, Lennox Head



Severity Comments:	<ul style="list-style-type: none"> • Speed ✘ • No barriers ✘ • Roadside hazards (poles/trees) ✘ • Wide run off area ✓ 	<ul style="list-style-type: none"> • Speed ✘ 	<ul style="list-style-type: none"> • High speed on Byron Bay Rd ✘ • Low speed in Byron St ✓ 	<ul style="list-style-type: none"> • Speed ✘ 	<ul style="list-style-type: none"> • Speed ✘ • No pedestrian refuge ✘ 	<ul style="list-style-type: none"> • Speed ✘ • No crossing facilities ✘ 	<ul style="list-style-type: none"> • Speed ✘ • No barriers ✘ • Roadside hazards (poles/trees) ✘
Severity Score:	2/4	3/4	4/4	3/4	4/4	4/4	4/4
Product (multiply scores)	16/64	36/64	48/64	24/64	8/64	16/64	36/64
TOTAL							184/448

5. Treatments to Improve Safe System Alignment

Table 4 and **Table 5** list treatments that would improve the Safe System alignment of the project:

- **Primary Treatments** are those measures that have the potential to eliminate or come close to eliminating the risk of fatal and serious injury (FSI) crashes.
- **Supporting Treatments** are effective in reducing the risk of FSI crashes but not to the extent of a primary treatment (i.e. there is a residual moderate or significant FSI crash risk). Implementation of a primary treatment should be given priority over a supporting treatment that may be targeting a similar crash risk.

Table 4: Primary Treatments

Treatments for consideration	Influence
Construct roundabout	Would reduce likelihood and severity of an FSI crash
Ban right turn into Byron Bay Road	Would reduce exposure to an FSI crash

Table 5: Supporting Treatments

Treatments for consideration	Influence
Left turn slip lane on Byron Bay Road	Would reduce likelihood of an FSI crash
Acceleration lane northbound and southbound	Would reduce likelihood of an FSI crash
Separate shared path for pedestrians and cyclists	Would reduce likelihood of an FSI crash
Reduce speed Byron Bay Road to 60kph	Would reduce severity of an FSI crash

6. Additional Safe System Components

As part of this SSA, consideration has been given to other components that comprise the Safe System i.e. road users, vehicles and post-crash care. Issues identified as relevant to this project are listed in **Table 6**.

Table 6: Other Safe System Components

Pillar	Prompts	Comments / Issues
Road user	<p>Are road users likely to be alert and compliant? Are there factors that might influence this?</p> <p>What are the expected compliance and enforcement levels (alcohol / drugs, speed, road rules and driving hours)? What is the likelihood of driver fatigue? Can enforcement activities be conducted safely?</p> <p>Are there special road users (e.g. entertainment precincts, elderly, children, on-road activities, motorcyclist route), distraction by environmental factors (e.g. commerce, tourism) or risk-taking behaviours?</p>	<ul style="list-style-type: none"> • Frustration due to delays at intersection – can result in taking risks entering through traffic • Tourists – may be unfamiliar with intersection • Bus route, including school buses • Popular recreational cycling route
Vehicle	<p>What level of alignment is there with the ideal of safer vehicles?</p> <p>Are there factors that may attract large numbers of unsafe vehicles? Is the percentage of heavy vehicles too high for the proposed / existing road design? Is this route used by recreational motorcyclists?</p> <p>Are there resources in the area to detect non-roadworthy, overloaded or unregistered vehicles and thus remove them from the network? Can enforcement activities be undertaken safely?</p> <p>Has vehicle breakdown been catered for?</p>	<ul style="list-style-type: none"> • Moderate amount of trucks and buses • Popular recreational cycling route • Popular location for RBT
Post-crash care	<p>Are there issues that might influence safe and efficient post-crash care in the event of a severe injury (e.g. congestion, access, stopping space)?</p> <p>Do emergency and medical services operate as efficiently as possible?</p> <p>Are other road users and emergency response teams protected during a crash event? Are drivers provided the correct information to address travelling speeds on the approach and adjacent to the incident? Is there reliable information available via radio, VMS etc?</p> <p>Is there provision for e-safety (i.e. safety systems based on modern information and communication technologies, C-ITS)?</p>	<ul style="list-style-type: none"> • Wide shoulders in Byron Bay Rd for emergency access • 12.5km to Ballina Hospital, police, ambulance, and other emergency services

7. Summary and Conclusions

A Safe System Assessment (SSA) has been conducted on the Byron Bay Road/Byron Street intersection at Lennox Head. Existing conditions and one concept design have been assessed. The SSA Matrix scores are summarized in the table below:

Option	Score
Existing conditions	200 / 448
Concept Design	184 / 448



It is clear that neither the existing or proposed intersection produces Safe System outcomes. The main FSI crash risks at the intersection are the right turn movements in and out of Byron Street, and the proposed Concept Design does not offer any structural improvement to these turns. Therefore, from the SSA Matrix scores, the proposed Concept Design only makes a marginal improvement to existing conditions.

However, by providing a separate left and right turn lanes in the Byron Street approach leg, left turning vehicles will be less likely to be trapped behind right turning vehicles. This should reduce queuing which will in turn reduce delays and driver frustration. Less frustrated drivers are less likely to take risks entering the Byron Bay Road traffic stream.

By moving the hold line forward (closer to the through lane), in association with an extension of a painted median, there will be an improvement in sight distance for right turning vehicles.

The proposed Concept Plan will enable an improved flow for left turning vehicles, and should reduce queue lengths and delays for right turning vehicles, and therefore reduce driver frustration. However, it is difficult to quantify the extent of these improvements, especially during peak periods, and therefore hard to justify any significant improvement in alignment with Safe System objectives.

Further treatment options to improve safety could be selected from the suggested treatments in Section 5 of this report. For example, there remains the potential for fatal and serious injury due crashes involving a vehicle turning right out of Byron Street. Sight distance is still obstructed by vehicles turning left into Byron Street. Safety could be greatly improved by providing a left turn slip lane. Safety at the intersection generally could be improved by reducing the speed limit on Byron Bay Road to 60km/h.

Measures that have the potential to eliminate or come close to eliminating the risk of fatal and serious injury (FSI) crashes could include the construction of a roundabout, or banning right turns into Byron Bay Road at the intersection.



8. Attachments

Attachment 1 Site Photographs



ATTACHMENT 1

Attachment 1: Site Photographs



Photo No. 1: Sight distance to the north with turning vehicle (note through vehicle beside rear of bus, still obstructed with stopped vehicle in front of hold line)



Photo No. 2: Location of existing hold line, set well back from through lane

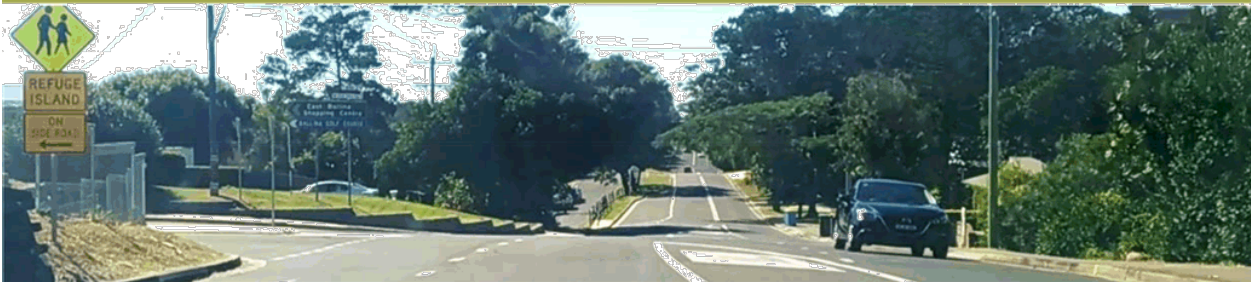

Photo No. 3: Existing westbound approach to intersection – single lane. Note narrow lane eastbound side

Road Safety Audit

Section A: Hill St/Pine Ave/The Coast Road

1.5km of Existing Road in East Ballina



GeoLINK
environmental management and design

PO Box 119
Lennox Head NSW 2478
T 02 6687 7666

PO Box 1446
Coffs Harbour NSW 2450
T 02 6651 7666

PO Box 1267
Armidale NSW 2350
T 02 6772 0454

PO Box 229
Lismore NSW 2480
T 02 6621 6677

info@geolink.net.au

Prepared for: Ballina Shire Council
© GeoLINK, 2020

7.4 **Traffic Issues, Hill Street/Pine Avenue/The Coast Road, East Ballina (Section A) – Road Safety Audit**

<i>UPR</i>	<i>Description</i>	<i>Date Issued</i>	<i>Issued By</i>
3586-1003	First issue	14/05/2020	MVE
3586-1010	Second issue	27/05/2020	MVE

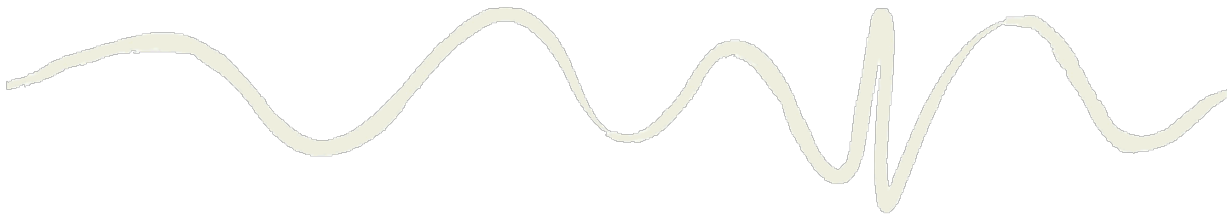

Table of Contents

1.	Project Information	1
1.1	Background	1
1.2	Site Description	2
1.3	Information Provided by the Client	3
1.4	Audit Scope	4
1.5	Audit Team	5
2.	Audit Process	6
2.1	Methodology and Responsibilities	6
2.2	Previous Audits	6
2.3	Commencement Meeting	6
2.4	Site Inspections	7
2.5	Completion Meeting	7
3.	Risk Matrix	8
4.	Audit Findings	9
5.	Recommendations	16
6.	Concluding Statement	17
6.1	Identified Deficiencies	17
6.2	Responding to the Audit	17
6.3	Concluding Statement	17

Tables

Table 1.1	Intersections within the audit area	3
Table 1.2	Crash Data - July 2014 to June 2019	4
Table 2.1	Steps and responsibilities	6
Table 3.1	How often is the problem likely to lead to a crash?	8
Table 3.2	What is the likely severity of the resulting crash type?	8
Table 3.3	Resulting level of risk	8
Table 3.4	Treatment approach	8
Table 4.1	Audit findings	9
Table 5.1	Recommendations for client consideration to improve road safety	16

Figures

Figure 1.1	Site Locality [Source: SIX Maps]	1
Figure 1.2	Site Detail [Source: SIX Maps]	2

Appendices

- Appendix A Site Photos
- Appendix B Correspondence from Local Residents



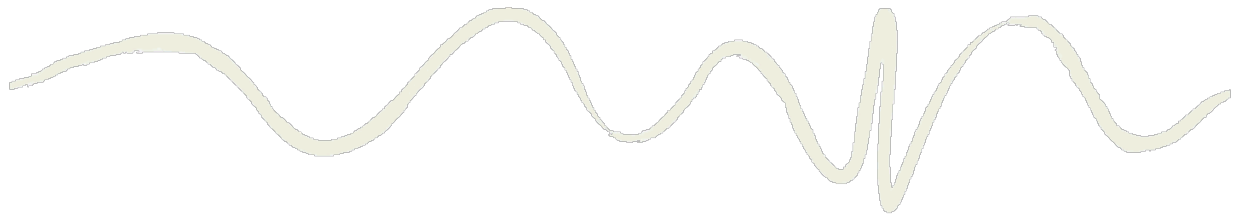

1. Project Information

1.1 Background

Ballina Shire Council (Council) has engaged GeoLINK to undertake two Road Safety Audits (RSA) for existing roads and road-related areas in the East Ballina/Shaws Bay area. This report is for Section A, being 1.5 km of existing road, including intersections, extending from the eastern end of Missingham Bridge to the change in speed zone from 60 km/h to 80 km/h. This stretch of road changes name twice and is known (from west to east) as Hill Street, Pine Avenue and The Coast Road.

Hill Street extends from Missingham Bridge to the intersection with Coogee Street. Between Coogee and Manly streets it becomes Pine Avenue, and beyond the Suvla Street intersection, it is The Coast Road.

A separate RSA is currently being undertaken for Section B, including part of Hill Street which falls in the scope of this audit. In addition to the intersection of Hill Street and Park Street/Brighton Street, the audit for Section B also comprises the area to the east including Brighton Street, Range Street and the publicly accessible road-related areas providing access and parking (formal and informal) to the nearby take-away shops, amenities block, caravan park and Shaws Bay Hotel.

Figure 1.1 below shows the whole stretch of Section A, and **Figure 1.2** overleaf shows the detail of the south western end of the site (Section B).



Figure 1.1 Site Locality [Source: SIX Maps]



7.4 Traffic Issues, Hill Street/Pine Avenue/The Coast Road, East Ballina (Section A) – Road Safety Audit



Figure 1.2 Site Detail [Source: SIX Maps]

1.2 Site Description

Council has provided the following description of the site:

Hill St/Pine Ave/The Coast Rd is part of a significant connector road that connects the east end of Ballina CBD via Kingsford Smith Drive, Hill Street, Pine Avenue and The Coast Road northwards to Angels Beach, Skennars Head and Lennox Head. Traffic volumes in 2014 were 4,079 vehicles per day and modelled to reach 4,662 by 2036. Hill St/Pine Ave traverses a constrained hilly section of East Ballina that is characterised by medium and low-density housing on the east [north] side and lower density housing and some natural areas on the west [south] side. Due to topographical and cost constraints, Hill St/Pine Ave is quite narrow with no provision for kerbside parking.

The audit area begins at the western end as Hill Street (chainage 0). At chainage 650 m, beyond the intersection with Coogee Street, Hill Street becomes Pine Avenue. Another 650 m east at the intersection with Suvla Street, it becomes The Coast Road. The change in speed zone is a further 200 m east of the Suvla Street intersection. The speed zone within the audit area is 60 km/h. The speed zone is delineated by 60 km/h speed signs at either end of the speed zone plus intermediate reinforcing speed zone signs (once in the eastbound direction following Missingham Bridge and twice in the westbound direction following the Suvla Street and Compton Drive intersections).

The existing road pavement and surface appears to be in good condition.

There is some street lighting along the length of the audit area and numerous power poles with overhead power lines.

7.4 Traffic Issues, Hill Street/Pine Avenue/The Coast Road, East Ballina (Section A) – Road Safety Audit

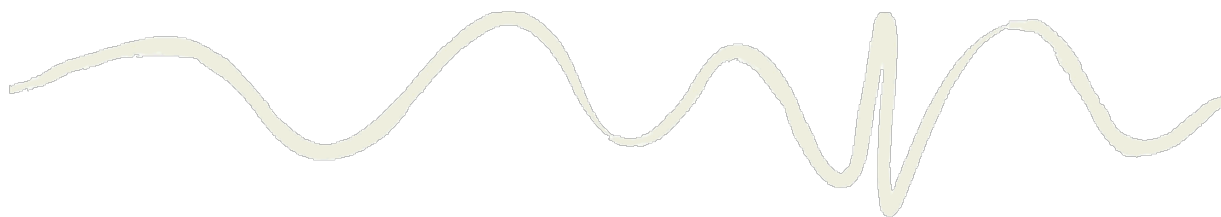

There are two bus stops on the eastbound route: east of the Coogee Street intersection, between the two Cronulla Street intersections; and on the westbound route sharing the informal channelised left turn lane into Brighton Street.

The route provides good connectivity for pedestrians and cyclists with sections of shared path and non-shared paths (i.e. < 2.5m in width). There are two pedestrian refuge islands: one between the Brighton Street/Park Street and Compton Drive intersections and the other at the tangent point of the Compton Drive intersection.

The audit area includes several intersections with varying significance and treatments. Details of the intersections are noted below.

Table 1.1 Intersections within the audit area

Street name	Location*	Turn Treatment
The Serpentine	60 m N	CHL Prohibited
Park Street	240 m N	CHL BAR
Brighton Street	240 m S	Informal CHL shared with bus bay AUR
Compton Drive	350 m S	BAL Prohibited
Coogee Street	650 m N	BAL BAR
Manly Street	900 m N	CHL CHR
Cronulla Street, west	1,000 m N	BAL BAR
Cronulla Street, east	1,100 m N	BAL BAR
Suvla Street	1,300 m S	CHL AUR

NOTES:

- Location is measured in metres west of the eastern end of Missingham Bridge
- 'N' or 'S' refers to which side (north or south) of Hill St/Pine Ave/The Coast Rd the side street extends
- CHL and CHR denote channelised left/right turn lane
- BAL and BAR denote basic left/right turns
- AUR refers to an auxiliary right turn lane.

The site, particularly the western end between Missingham Bridge and Compton Drive is known to be popular with locals and visitors with an influx of beach-goers, holidaymakers and patrons to the Shaws Bay Hotel on weekends during the summer months and school holidays This area is the focus of the separate RSA carried out for Section B.

Photos of the audit area taken from video footage recorded on Sunday the 26th of April 2020 by the lead auditor are provided in **Appendix A**.

1.3 Information Provided by the Client

In addition to the site description, the following background information has been provided by Council:

The absence of a parking lane causes access from Hill Street to and from adjacent properties to be problematic in terms of sight distance and gap selection.

The current speed limit of 60 km/h is higher than the default urban speed limit of 50 km/h as this street was identified as part of a major through road in the network and exempted at the time the default 50 km/h speed limit was being implemented. The 60 km/h speed zone starts 200 m north of Suvla Street (north of this it is 80 km/h) and continues through to River Street where it becomes 50 km/h.



7.4 Traffic Issues, Hill Street/Pine Avenue/The Coast Road, East Ballina (Section A) – Road Safety Audit

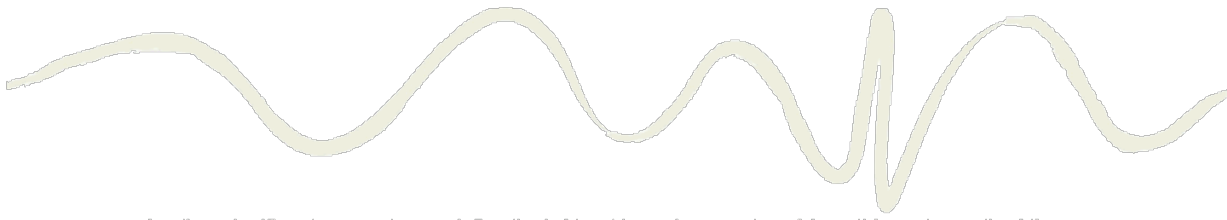

Another significant connector road, Bentinck Street branches westward from this route south of the Missingham Bridge. Bentinck Street is also a 60 km/h speed zone until it reverts to the 50 km/h urban default west of Martin Street.

This road safety audit arises from concerns expressed by adjacent residents about vehicle and pedestrian safety and whether the current 60 km/h speed limit is appropriate on this section of Hill St/Pine Ave/The Coast Rd.

The following crash data has been provided, capturing all reported crashes in the vicinity of the audit site for the five-year period between the 1st of July 2014 and the 30th of June 2019. Each incident below resulting in at least one injury.

Table 1.2 Crash Data - July 2014 to June 2019

ID	Date	Time	Crash description
1064677	Th 12/02/2015	1700	V1 rear-ended V2 while V2 was slowing to turn right into Manly St.
1076137	We 5/08/2015	0715	P1 was struck by V1 while walking in opposite direction to traffic flow north of Compton Dr.
1098166	Tu 8/03/2016	1440	V1, attempting to turn right out of Manly St. collided with V2 travelling east on Pine Ave.
1102961	We 13/04/2016	1800	V1 collides with V2 at Suvla St intersection
1124822	We 5/10/2016	0945	V1 left carriageway at Coogee St. intersection, colliding with object
1126276	Th 12/01/2017	1457	V1 rear-ended V2 at Compton Dr. intersection
1138765	Tu 14/03/2017	0800	V1 left carriageway at Compton Dr. intersection
1145968	We 26/07/2017	1600	V1 rear-ended V2 south of Coogee St. intersection
1167209	Sa 8/04/2018	1830	P1 was struck by V1 while attempting to cross roadway

Shaded times denote crashes occurring outside of daylight hours. V denotes vehicle, P denotes pedestrian

The crash data doesn't reveal any trend or particularly hazardous location within the RSA area. All incidents occurred at or near intersections within the Hill Street/Pine Avenue section. Nine recorded crashes within the five-year period is considered disproportionately large and suggests there may be inherent hazards associated with the road network.

The Council also provided the audit team with a number of emails and letters from concerned residents. Copies with names and addresses removed are in **Appendix B**.

1.4 Audit Scope

This RSA will assess the existing road alignment, cross section, intersections, pathways and pedestrian/cyclist safety, signage, property access, roadside obstacles and other related infrastructure between the eastern end of Missingham Bridge and the 80 km/h speed sign. The appropriateness of the current 60 km/h speed limit will also be assessed.

The scope of the RSA is limited to the existing infrastructure within the carriageway and verges of Hill Street, Pine Avenue and The Coast Road, including intersections, between the eastern end of Missingham Bridge and the change in speed zone approximately 200m east of the Suvla Street intersection.

There is some cross-over between the areas of Section A and Section B, mainly being the intersection of Hill Street and Park Street/Brighton Street and the Hill Street frontage of the Section B area. Deficiencies identified within the common area will be included in both audits.

7.4 Traffic Issues, Hill Street/Pine Avenue/The Coast Road, East Ballina (Section A) – Road Safety Audit

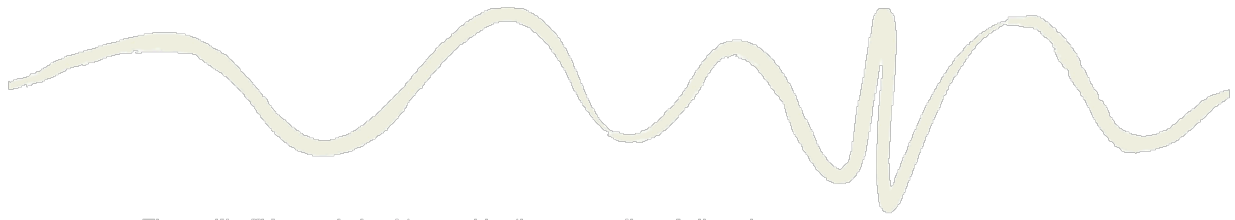

The audit will be carried out to consider the perspective of all road users.

The objective of the RSA is to identify any potential road safety issues or design deficiencies associated with the existing road that may need to be mitigated or rectified.

Although the RSA will not check the existing roadway against relevant standards and guidelines, some design-related compliance issues may be raised during the audit process.

Positive aspects of the road and infrastructure have not been recorded.

1.5 Audit Team

The audit has been carried out by suitably qualified team members registered as Road Safety Auditors by Transport for NSW.

1. Michelle Erwin

BE(Civil)(Hons), MTraf
Senior Civil Engineer, GeoLINK
Level 3 Lead Road Safety Auditor

2. Graeme Robertson

BEtech(Civil)
Asset Management Coordinator, Richmond Valley Council
Level 2 Road Safety Auditor

3. Jarrod Connell

BE(Civil)
Civil Engineer, GeoLINK
Level 1 Road Safety Auditor

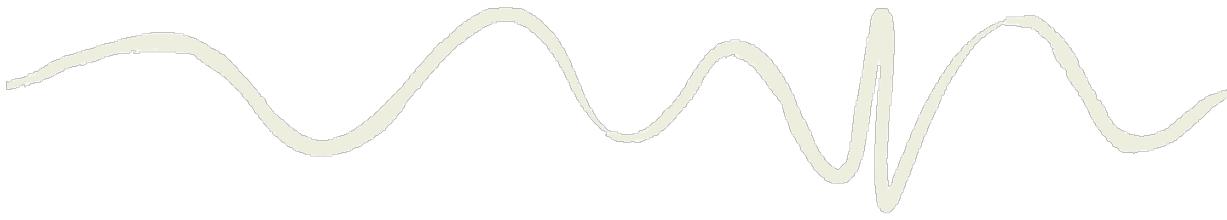

2. Audit Process

2.1 Methodology and Responsibilities

The RSA has been undertaken in accordance with:

- Austroads *Guide to Road Safety Part 6A: Implementing Road Safety Audits (2019)*; and
- NSW RMS *Guidelines for Road Safety Audit Practices (2011)*,

The RSA process includes the steps listed in the table below together with the party responsible for each task.

Table 2.1 Steps and responsibilities

Steps	Responsibility
Select the audit team	Client or Designer
Provide background information	Client or Designer
Hold a commencement meeting	Client and/or Designer and the Audit Team
Assess the documents / Inspect the site	Audit Team
Write the audit report and issue to client	Audit Team
Hold a completion meeting	Client and/or Designer and the Audit Team
Write the responses	Client and Designer
Implement the changes	Client or Designer

The client and designer in this case are both Ballina Shire Council.

2.2 Previous Audits

No previous RSAs have been carried out for this site. However, a separate RSA is currently being undertaken for Section B, including part of Hill Street which falls in the scope of this audit. Refer **Section 1.1**.

2.3 Commencement Meeting

An initial meeting was held on site with Patrick Knight and Brett Howard from Council (the client) and Michelle Erwin from GeoLINK (lead auditor) on Thursday the 30th of April 2020. During the meeting, the scope of the audit was confirmed, as described in this report.

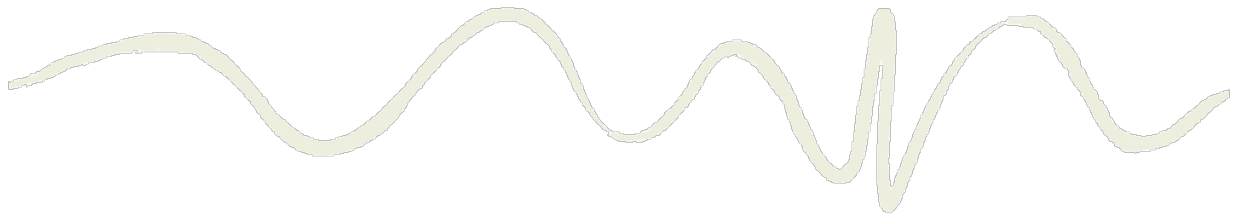

2.4 Site Inspections

The site investigation was undertaken by the audit team on the afternoon and evening of Thursday the 30th of April between 16:00pm and 18:30pm. The audit team drove the stretch of road between Missingham Bridge and the change in speed zone in both directions numerous times in daylight and night conditions. Further, the audit team walked along several sections of the existing pathways within the audit area.

Additionally, the lead auditor is very familiar with the road network in the vicinity of the proposed works, given the proximity to home and work.

The audit was carried out during the period of COVID19 lockdown, whereby picnics, sunbaking, gathering of non-household members greater than two people and any other non-essential, non-exercise related activities were banned. It was not a school holiday period. The weather was fine at the time of the site visit and there had been little to no rain in the 24 hours prior.

2.5 Completion Meeting

The objective of the completion meeting is to allow the auditor(s) to discuss the findings with the client for corrective action, where required. Although the meeting is not an occasion for the client to disagree with the audit findings, it is an opportunity for misunderstandings to be explained.

The completion meeting was held on the 27th of May 2020 by telephone between Michelle Erwin (Lead Auditor) and Patrick Knight (Council, the client), following submission of the audit report.

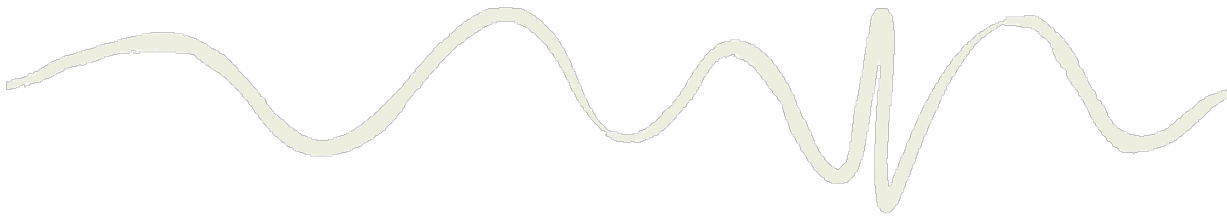

3. Risk Matrix

The audit findings include a risk ranking, determined using **Table 3.1** to **Table 3.4**, reproduced from The Austroads *Guide to Road Safety Part 6A*.

Table 3.1 How often is the problem likely to lead to a crash?

<i>Frequency</i>	<i>Description</i>
Frequent	Once or more per week
Probable	Once or more per year (but less than once per week)
Occasional	Once every five to ten years
Improbable	Less often than once every ten years

Table 3.2 What is the likely severity of the resulting crash type?

<i>Severity</i>	<i>Description</i>	<i>Examples</i>
Catastrophic	Likely multiple deaths	<ul style="list-style-type: none"> ▪ High-speed, multi-vehicle crash on a freeway. ▪ Car runs into crowded bus stop. ▪ Bus and petrol tanker collide. ▪ Collapse of a bridge or tunnel.
Serious	Likely death or serious injury	<ul style="list-style-type: none"> ▪ High or medium-speed vehicle/vehicle collision. ▪ High or medium-speed collision with a fixed roadside object. ▪ Pedestrian or cyclist struck by a car.
Minor	Likely minor injury	<ul style="list-style-type: none"> ▪ Some low-speed vehicle collisions. ▪ Cyclist falls from bicycle at low speed. ▪ Left-turn rear-end crash in a slip lane.
Limited	Likely trivial injury or property damage only	<ul style="list-style-type: none"> ▪ Some low-speed vehicle collisions. ▪ Pedestrian walks into object (no head injury). ▪ Car reverses into post.

Table 3.3 Resulting level of risk

	<i>Frequent</i>	<i>Probable</i>	<i>Occasional</i>	<i>Improbable</i>
<i>Catastrophic</i>	Intolerable	Intolerable	Intolerable	High
<i>Serious</i>	Intolerable	Intolerable	High	Medium
<i>Minor</i>	Intolerable	High	Medium	Low
<i>Limited</i>	High	Medium	Low	Low

Table 3.4 Treatment approach

<i>Frequency</i>	<i>Description</i>
Intolerable	Must be corrected
High	Should be corrected or the risk significantly reduced, even if the treatment cost is high
Medium	Should be corrected or the risk significantly reduced, if the treatment cost is moderate but not high
Low	Should be corrected or the risk reduced, if the treatment cost is low

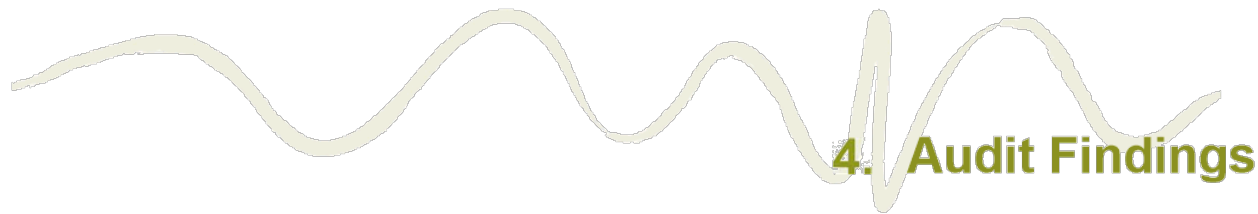

4. Audit Findings

The following table details the findings of the RSA. The client responses were provided by Patrick Knight of Ballina Shire Council and added in the second issue of this report.

Table 4.1 Audit findings

Audit findings	Risk Ranking	Client	
		Accept Yes/No	Comments
1.0 GEOMETRY			
<p>1.1 Vehicles queuing to turn right into Brighton Street Several eastbound vehicles were observed queuing to turn right into Brighton Street from Hill Street. Eastbound through traffic was required to use the auxiliary lane to pass these vehicles. The auxiliary lane appeared somewhat short given the number of vehicles observed in the through lane waiting for a gap in the oncoming traffic to allow a right turn, and it is expected the volumes of traffic for all manoeuvres in the area would be greater during peak summer periods.</p> <p>Vehicles travelling eastbound at 60 km/h off Missingham Bridge, rounding the left-hand bend may not perceive the stopped vehicles ahead in the through lane and may rear-end vehicles queued to turn right.</p> <p>It is recommended that consideration be given to reconfiguration of this intersection in conjunction with the area to the east of Brighton Street.</p>	Occasional <i>Limited</i> Low	Yes	Will be considered with options for the Section B RSA.
<p>1.2 Property access on the south side of Hill Street / Pine Avenue The existing geometry on Hill Street (cross section and vertical curves) between Compton Drive and Manly Street makes it difficult for vehicles to access properties on the south side of Hill Street / Pine Avenue. Residents will need to reverse into oncoming traffic with limited sight distance.</p> <p>There is a risk that through traffic will collide with residents/visitors access the existing driveways within this portion of the audit area. The resulting crash may be a rear-end or a head on collision.</p> <p><i>Refer to 3.2, 3.3 and 5.2 for recommendations that will mitigate this risk.</i></p>	Probable <i>Minor</i> High	Yes	To the extent that it can be dealt with by adoption of the recommendations for 3.2, 3.3 and 5.2 (clear 'concealed driveway signage in both directions and a reduction in the speed zone).

Audit findings	Risk Ranking	Client	
		Accept Yes/No	Comments
<p>1.3 Shared bus zone and left turn lane The bus zone on Hill Street between Brighton Street and Compton Drive is also used as the left turn lane for westbound traffic turning from Hill Street into Brighton Street. Vehicles wanting to turn left here while a bus is standing in the bus zone will either need to wait in the Hill Street through lane (potentially resulting in a rear-end collision) or turn in front of the bus (potentially resulting in the bus colliding with the passenger side of the turning vehicle).</p> <p><i>Refer 1.1 for recommendations that will mitigate this risk.</i></p>	<p><i>Occasional</i> <i>Minor</i> Medium</p>	Uncertain	Depends on what comes out of the Section B of the RSA.
<p>1.4 Bus obscuring view for motorists exiting Brighton Street A bus stopped in the bus zone on Hill Street between Brighton Street and Compton Drive would obscure the view of westbound traffic on Hill Street for motorists wishing to exit Brighton Street.</p> <p>This may result in a broadside crash between the vehicle leaving Brighton Street and through-traffic travelling west past the stopped bus.</p> <p><i>Refer 1.1 for recommendations that will mitigate this risk.</i></p>	<p><i>Improbable</i> <i>Serious</i> Medium</p>	Uncertain	Depends on what comes out of the Section B of the RSA.
<p>1.5 Hill Street / Compton Drive intersection The Hill Street / Compton Drive intersection allows right turn into Compton Drive and left turn out of Compton Drive (with a stop sign). Due to the geometry at the intersection, left turns from Hill Street into Compton Drive and right turns out of Compton Drive are prohibited.</p> <p>There is a risk that vehicles waiting to turn into or out of Compton Drive will be struck by vehicles travelling westbound (downhill) on Hill Street. The risk is increased for the vehicles turning left out of Compton Drive due to the angle of the intersection forcing drivers to look backwards to check for oncoming traffic. The risk is further increased during the winter months when the morning sun prevents a clear view of westbound traffic for motorists turning into or out of Compton Drive. The resulting collision would be a broadside crash.</p> <p><i>Refer to 5.2 for recommendations that will mitigate this risk.</i></p>	<p><i>Occasional</i> <i>Serious</i> High</p>	Yes	To the extent that it could be addressed by adoption of 5.2 (reduction in speed zone).

Audit findings	Risk Ranking	Client	
		Accept Yes/No	Comments
<p>1.6 Bus obscuring view for motorists existing Coogee Street A bus stopped in the bus zone on Pine Avenue immediately east of Coogee Street would obscure the view of westbound traffic from motorists wishing to turn right out of Coogee Street. This may result in a broadside crash between the right-turning vehicle and westbound through traffic.</p> <p>It is recommended that investigations be made into the possibility of relocating this bus stop.</p>	<p><i>Occasional Limited</i></p> <p>Low</p>	No	This would be cost prohibitive at this location given the physical constraints.
<p>1.7 Narrow carriageway on Hill Street The carriageway and verges on Hill Street between Compton Drive and Manly Street feel narrow from the perspective of a motorist. The presence of a 1.5-2.0 m high retaining wall less than a metre from the edge of the travel lane (kerb lip) of the eastbound lane and a footpath immediately behind the kerb of the westbound lane does not provide much (if any) room for error along this stretch of road.</p> <p>There is a risk that any errant vehicle will collide with oncoming vehicles/pedestrians/cyclists, given the lack of available space to avoid a collision.</p> <p><i>Refer to 5.2 for recommendations that will mitigate this risk.</i></p>	<p><i>Occasional Serious</i></p> <p>High</p>	Yes	To the extent that it could be addressed by adoption of 5.2 (reduction in speed zone).
2.0 PARKING			
<p>2.1 On-street parking There is no space available on Hill Street, Pine Avenue or The Coast for on-street parking. This is particularly problematic between Compton Drive and Manly Street, given the number of dwellings and unit developments on the southern side of Hill Street, none of which appear to provide any on-site visitor parking. Cars were observed parking on the footpath, reducing the walkway area for pedestrians and cyclists.</p> <p>There is a risk that vehicles parked on the footpath will damage property or strike a pedestrian using the footpath.</p> <p>It is recommended that consideration be given to installing signage to prohibit parking on the verge/footpath on the southern side of Pine Avenue.</p>	<p><i>Occasional Minor</i></p> <p>Low</p>	No	<p>Parking is already prohibited on the footpath/verge by NSW Road Rules, and redundant signage is not provided by Council.</p> <p>Consideration however can be given to installation of bollards and/or increased compliance action by parking rangers.</p>



Audit findings	Risk Ranking	Client	
		Accept Yes/No	Comments
3.0 SIGNAGE AND LINEMARKING			
<p>3.1 Linemarking appeared to be non-reflective The linemarking within the audit area appeared to be non-reflective during the night audit. Further, the right turn arrows for the CHR into Compton Drive were faded.</p> <p>Ill-defined lane and movement definition can result in crashes if motorists are unclear where they should be within the road carriageway.</p> <p>It is recommended that linemarking be refreshed and maintained as required.</p>	<p><i>Improbable</i> <i>Minor</i></p> <p>Low</p>	Yes	Can be refreshed when contractor available.
<p>3.2 Concealed Driveways Ahead - westbound The Concealed Driveways Ahead sign on Pine Avenue advising westbound traffic of the presence of driveways up ahead on Hill Street is in poor condition and non-reflective. Motorists not anticipating the possibility of vehicles slowing to enter a driveway or reversing out of a driveway may collided with these vehicles</p> <p>It is recommended that this sign be cleaned and/or replaced, as appropriate.</p>	<p><i>Occasional</i> <i>Minor</i></p> <p>Medium</p>	Yes	-
<p>3.3 Concealed Driveways Ahead - eastbound There is no Concealed Driveways Ahead sign on Hill Street advising eastbound traffic of the presence of driveways. Although the driveways are all on the southern side of Hill Street, residents access the driveways may approach and stop in the eastbound lane. Similarly, residents leaving their driveways may reverse into the eastbound lane if they intent on travelling eastwards.</p> <p>It is recommended that this sign be installed in an appropriate location for eastbound traffic.</p>	<p><i>Occasional</i> <i>Minor</i></p> <p>Medium</p>	Yes	-
<p>3.4 Shared path sign at Brighton Street The Shared Path / End sign on the south eastern corner of the Hill Street / Brighton Street intersection appears to have been hit by a vehicle and is leaning into the shared path.</p> <p>It is recommended this sign be repaired as required.</p>	<p>Comment only</p>	Noted	-

Audit findings	Risk Ranking	Client	
		Accept Yes/No	Comments
4.0 PEDESTRIANS AND CYCLISTS			
<p>4.1 Minimal streetlighting near Park Street / Brighton Street intersection Minimal street lighting was observed on Hill Street between the Park Street / Brighton Street intersection and the Compton Drive intersection. Given that this area is very popular with pedestrians and includes take away shops and a pub open beyond daylight hours, there is a risk that motorists may strike a pedestrian crossing the street after dark.</p> <p>It is recommended that consideration be given to engaging a streetlighting expert to assess the area for compliance with best practices.</p>	<p><i>Occasional Serious</i></p> <p>High</p>	<p>Yes</p>	<p>Will be considered with options for the Section B of RSA.</p>
<p>4.2 Shared paths Although the area is very popular with pedestrians and cyclists, particularly the western end of the site, the majority of the footpaths are not wide enough to be shared pedestrian and cyclist facilities.</p> <p>There is a risk that a cyclist may collide with a pedestrian attempting to share the available footpath space, or a pedestrian/cyclist may trip over an obstacle on the path.</p> <p>It is recommended that consideration be given to improving the shared path network east and south of Compton Drive.</p>	<p><i>Occasional Minor</i></p> <p>Medium</p>	<p>Yes, partially</p>	<p>Consideration can be given when Pedestrian Access and Mobility Plan (PAMP) is next reviewed.</p> <p>However, the road layout does not allow for an upgrade without extensive works.</p> <p>Alternative bike path arrangements/ options would need to be investigated.</p>
<p>4.3 Obstacles within walkway area The concrete path fronting the dwellings and unit developments on the south side of Hill Street between Compton Drive and Manly Street is 'shared' with parked vehicles and wheelie bins, further narrowing the walkway area. The concrete surface itself is narrow and undulating, partially due to the frequency of service pit lids and driveway crossings.</p> <p>There is a risk that pedestrians or cyclists using the path will trip over one of the hazards.</p> <p><i>Refer 2.1 and 4.2 for recommendations that may mitigate this risk.</i></p>	<p><i>Occasional Limited</i></p> <p>Low</p>	<p>Yes, partially</p>	<p>As per 4.2 above.</p>

Audit findings	Risk Ranking	Client	
		Accept Yes/No	Comments
<p>4.4 Crossing Hill Street between Missingham Bridge and Park Street / Brighton Street There is no defined safe crossing point on Hill Street between Missingham Bridge and Park Street / Brighton Street. However, there is a shared path extending from the 'North Wall' meeting with the shared path running along the south side of Hill Street. Several pedestrians were observed crossing Hill Street at various locations between Park / Brighton street and The Serpentine (many more so during peak summer periods).</p> <p>It is apparent that the desire lines and convenience for many pedestrians does not extend north up Hill Street to the existing pedestrian refuge. Motorists would not expect pedestrians to be crossing away from the refuge and may strike a pedestrian while travelling at 60 km/h.</p> <p><i>Refer 1.1 and 5.2 for recommendations that will mitigate this risk.</i></p>	<p><i>Occasional Serious</i></p> <p>High</p>	<p>Yes</p>	<p>Can be addressed as suggested by 1.1 (redesign of intersection) and 5.2 (reduction of speed zone), and outcomes of the RSA for Section B.</p>
<p>4.5 Guard rail protection There is a timber board affixed to the rear of the existing guard rail on the south west corner of the Hill Street / Compton Drive intersection, adjacent to the shared path. This is presumably to prevent cyclists from incurring an injury if they were to collide with the unprotected rear of the guardrail. However, the board appears to be insufficient to achieve this goal and is presumed to be non-compliant with current Australian Standards for shared paths and cycleways.</p> <p>It is recommended that the intention of this fixture be considered to ensure it does not pose an additional safety risk, specifically for cyclists.</p>	<p>Comment only</p>	<p>Yes</p>	<p>Will be investigated.</p>
<p>5.0 OTHER</p>			
<p>5.1 Vegetation reducing intersection sight distance Vegetation on north west side of Hill Street / Coogee Street intersection partly obscures view of eastbound traffic from motorists waiting to turn out of Coogee Street.</p> <p>There is a risk that a vehicle leaving Coogee Street will be struck by eastbound through traffic.</p> <p>It is recommended that all roadside vegetation be monitored and maintained to ensure signage is visible and intersection sight distance is maximised.</p>	<p><i>Improbable Minor</i></p> <p>Low</p>	<p>Yes</p>	<p>-</p>

Audit findings	Risk Ranking	Client	
		Accept Yes/No	Comments
<p>5.2 Speed environment</p> <p>The current speed zone of 60 km/h is at odds with the existing land use, being residential with a high volume of pedestrians and cyclists (with no grade-separation or dedicated crossings). The existing 60 km/h speed zone creates an environment whereby the priority is given to the efficiency of the through traffic. However, the area includes a number of intersections – some with limited sight distance – driveways to access dwellings and unit developments, commercial enterprises, popular beach/picnic/recreational activity destinations.</p> <p>The 60 km/h speed of through traffic increases the severity of any crash when compared to the standard 50 km/h urban speed zone. Further, it suggests that the primary function is through traffic movement, which was not observed to be the case.</p> <p>The 60 km/h speed zone presents a risk that motorists will not anticipate the prevalence of pedestrians, cyclists, turning vehicles (at intersections and driveways), buses etc. that frequent the area.</p> <p>It is recommended that consideration be given to applying for a speed zone reduction for the full length of the audit area to provide a 50 km/h speed zone.</p> <p>It is noted that if the speed zone drops from 60 km/h to 50 km/h, the risk ranking for a number of other audit findings will be affected due to the reduced likelihood of a collision and/or the reduced severity of collision, as follows:</p> <ul style="list-style-type: none"> ▪ 1.2 would drop from HIGH to MEDIUM (<i>Probable to Occasional</i>) ▪ 1.5 could drop from HIGH to MEDIUM if speed limits were obeyed (<i>Serious to Minor</i>) ▪ 1.7 would also drop from HIGH to MEDIUM (<i>Serious to Minor</i>) ▪ 3.2, 3.3, 4.4, and 5.1 and 3.3 would also improve, but no change in rating 	<p><i>Probable</i></p> <p><i>Minor</i></p> <p>High</p>	<p>Yes</p>	<p>Council can request TfNSW to carry out speed zone review based on the findings of this RSA.</p>

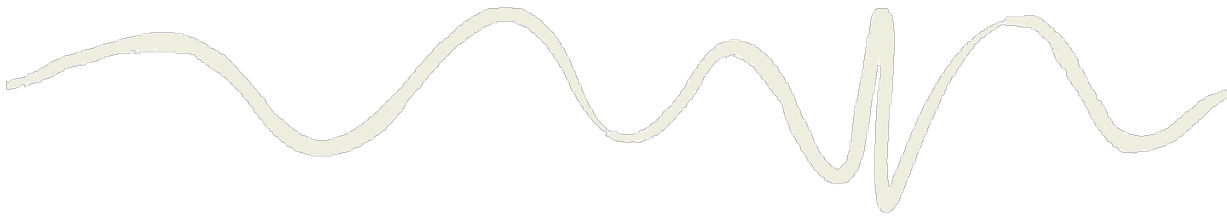

5. Recommendations

The following recommendations are proposed for consideration by the client in relation to improving the safety for road users within the audit area.

Table 5.1 Recommendations for client consideration to improve road safety

<i>Audit finding</i>	<i>Recommendations</i>
1.1, 1.3, 1.4, 4.4	Consider reconfiguration of the Hill Street / Park Street / Brighton Street intersection in conjunction with the area to the east of Brighton Street (refer to RSA for Section B, GeoLINK, 2020).
1.2, 3.2, 3.3	Clean and/or replace the 'Concealed Driveways Ahead' sign on Pine Avenue (westbound traffic) and install a similar sign appropriately located on Hill Street for eastbound traffic.
1.2, 1.5, 1.7, 3.2, 3.3, 4.4, 5.2	Apply for a speed zone reduction to provide a 50 km/h zone for the full length of the audit area.
1.6	Investigate relocating the bust stop on Pine Avenue immediately east of Coogee Street.
2.1, 4.3	Install signage to prohibit parking on the verge/footpath on the southern side of Pine Avenue.
3.1	Refresh and maintain linemarking.
3.4	Repair Shared Path sign on the south eastern corner of the Hill / Brighton Street intersection.
4.1	Engage a streetlighting expert to assess the area for compliance with best practices.
4.2, 4.3	Improve shared path networks east and south of Compton Drive.
4.5	Consider the intention and appropriateness of the timber board fixed to the rear of the guard rail on the south west corner of the Hill Street / Compton Drive intersection and check compliance against current relevant standards.
5.1	Monitor and maintain all roadside vegetation to ensure signage is visible and intersection sight distance is maximised.

Note that audit findings are colour coded according to the risk ranking determined in Section 4: Low, Medium, High

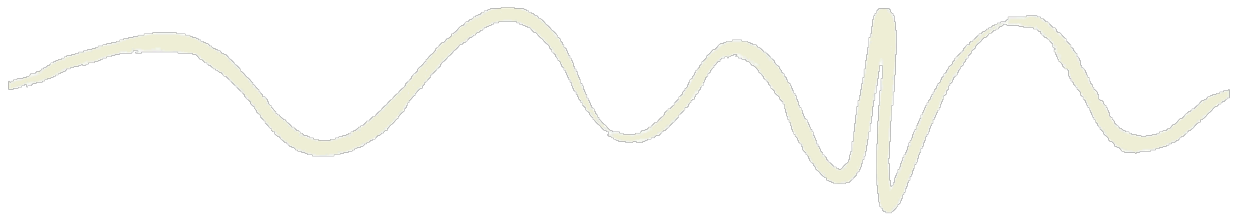

6. Concluding Statement

6.1 Identified Deficiencies

The audit process seeks to identify potential safety hazards. However, there is no guarantee that every deficiency has been identified. Further, even if all audit findings are addressed, this will not necessarily guarantee a safe site. Rather, addressing the findings of this report should improve the level of safety offered by the existing road network within the audit area.

As per **Section Error!** Reference source not found., several deficiencies have been identified. The risk associated with each issue has been assessed. As per **Table 3.4**, any issue with a risk ranking of 'medium' should be corrected if the cost of treatment is moderate. Issues with a risk rating of 'high' or 'intolerable' should be corrected or the risk significantly reduced even if the cost of treatment is high.

6.2 Responding to the Audit

As set out in the RSA guidelines, responsibility for the road design always rests with the client, and not with the auditor. A client is under no obligation to accept all the audit recommendations. Also, it is not the role of the auditor to agree to or approve of the client's response to the audit. Rather, the audit provides the opportunity to highlight potential problems and have them formally considered by the client, in conjunction with all other project considerations.

This formal RSA report should be responded to in writing, giving reasons for each rejection of an audit finding or recommendation. Acceptance of a recommendation may require no further comment, but explanation of how or when the action will be taken may be useful. The audit response does not need to be provided to the audit team but should be kept on file as a record of due diligence.

6.3 Concluding Statement

Each member of the audit team has examined the plans listed in **Error!** Reference source not found.. The audit has been carried out for the sole purpose of identifying any features of the existing road network within the audit scope which could be altered or removed to improve the safety of the proposal. The identified issues have been noted in this report and given a risk rating. The accompanying findings are provided to for the consideration by the client for implementation.

14th May 2020

Michelle Erwin (Audit Team Leader)

14th May 2020

Graeme Robertson (Audit Team Member)

14th May 2020

Jarrod Connell (Audit Team Member)

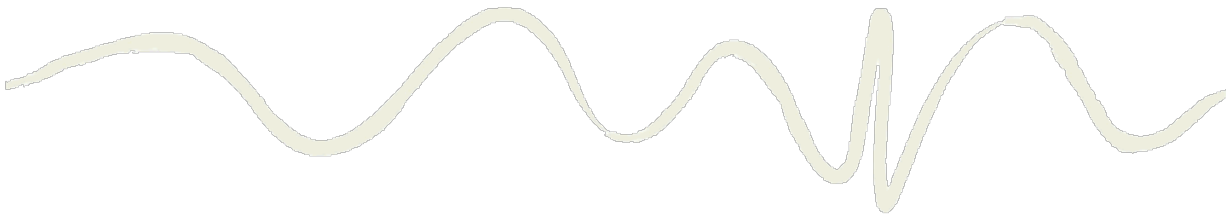

Copyright and Usage

©GeoLINK, 2020

This document, including associated illustrations and drawings, was prepared for the exclusive use of Ballina Shire Council. It is not to be used for any other purpose or by any other person, corporation or organisation without the prior consent of GeoLINK. GeoLINK accepts no responsibility for any loss or damage suffered howsoever arising to any person or corporation who may use or rely on this document for a purpose other than that described above.

This document, including associated illustrations and drawings, may not be reproduced, stored, or transmitted in any form without the prior consent of GeoLINK. This includes extracts of texts or parts of illustrations and drawings.

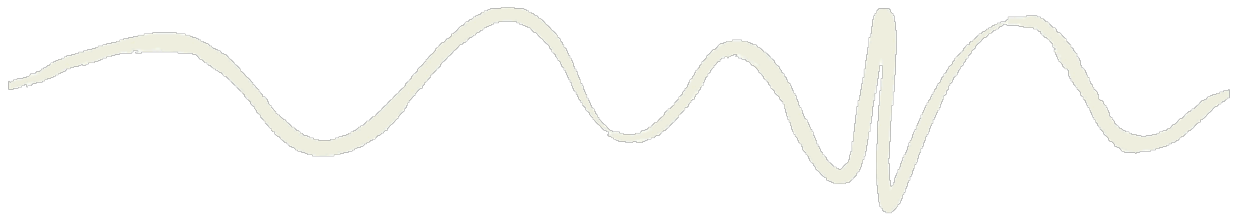

Appendix A
Site Photos



7.4 Traffic Issues, Hill Street/Pine Avenue/The Coast Road, East Ballina (Section A) – Road Safety Audit

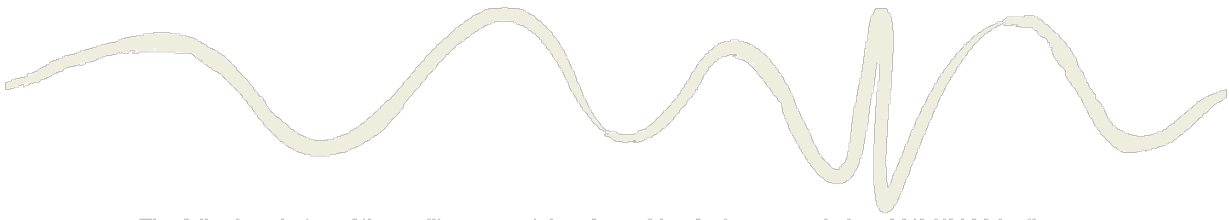

The following photos of the audit area are taken from video footage recorded on 26/04/2020 by the lead auditor. The western end of the audit site (being the eastern end of Missingham Bridge) is Chainage 0m and the eastern end of the audit site (being the 80 km/h sign) is Chainage 1,500m.

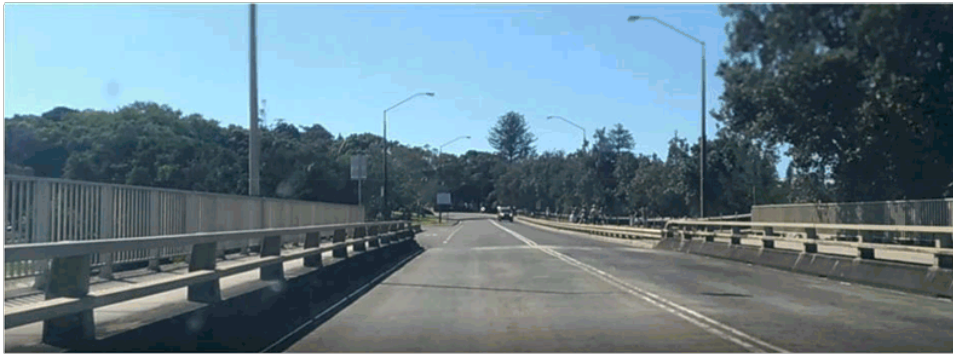

Photo 1 – CH 0 – View to the EAST – East end of Missingham Bridge

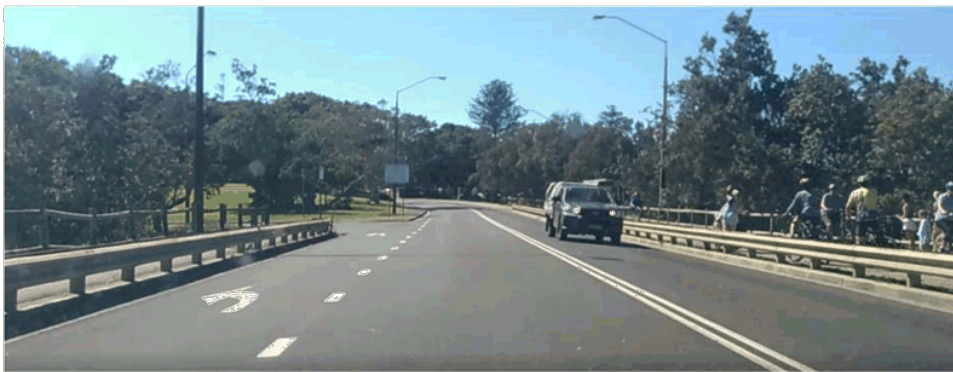

Photo 2 – CH 50 – View to the EAST – Intersection with The Serpentine



Photo 3 – CH 150 – View to the EAST



Road Safety Audit – Section A: HillStreet/Pine Avenue/The Coast Road
3586-1010

7.4 **Traffic Issues, Hill Street/Pine Avenue/The Coast Road, East Ballina (Section A) – Road Safety Audit**

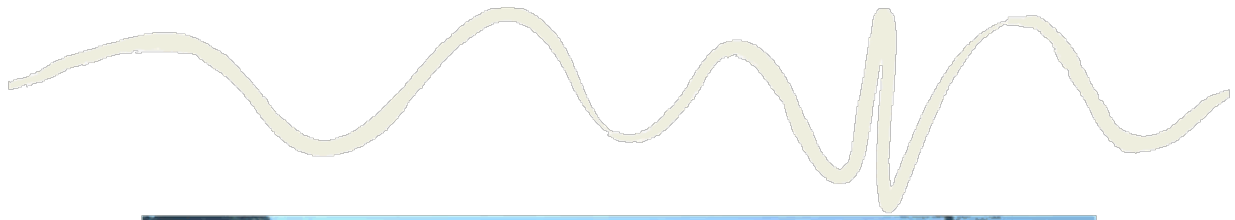

Photo 4 – CH 200 – View to the EAST – Intersection with Park Street (left) and Brighton Street (right)



Photo 5 – CH 240 – View to the EAST – Centre of intersection with Park Street and Brighton Street



Photo 6 – CH 350 – View to the EAST – Intersection with Compton Drive



Road Safety Audit – Section A: Hill Street/Pine Avenue/The Coast Road
3586-1010

7.4 Traffic Issues, Hill Street/Pine Avenue/The Coast Road, East Ballina (Section A) – Road Safety Audit



Photo 7 – CH 500 – View to the EAST



Photo 8 – CH 600 – View to the EAST – Intersection with Coogee Street



Photo 9 – CH 650 – View to the EAST – Bus Stop



Road Safety Audit – Section A: Hill Street/Pine Avenue/The Coast Road
3586-1010

7.4 Traffic Issues, Hill Street/Pine Avenue/The Coast Road, East Ballina (Section A) – Road Safety Audit

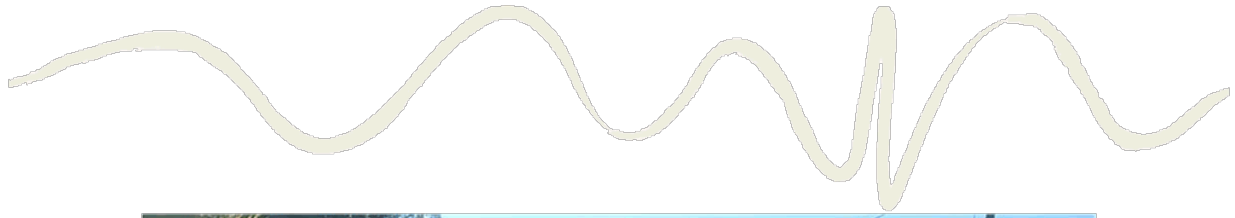

Photo 10 – CH 750 – View to the EAST



Photo 11 – CH 850 – View to the EAST – Start of CHL for the intersection with Manly Street



Photo 12 – CH 900 – View to the EAST – Intersection with Manly Street



Road Safety Audit – Section A: HillStreet/Pine Avenue/The Coast Road
3586-1010

7.4 Traffic Issues, Hill Street/Pine Avenue/The Coast Road, East Ballina (Section A) – Road Safety Audit



Photo 13 – CH 925 – View to the EAST



Photo 14 – CH 950 – View to the EAST – Intersection with western end of Cronulla Street



Photo 15 – CH 1,000 – View to the EAST



Road Safety Audit – Section A: HillStreet/Pine Avenue/The Coast Road
3586-1010

7.4 **Traffic Issues, Hill Street/Pine Avenue/The Coast Road, East Ballina (Section A) – Road Safety Audit**

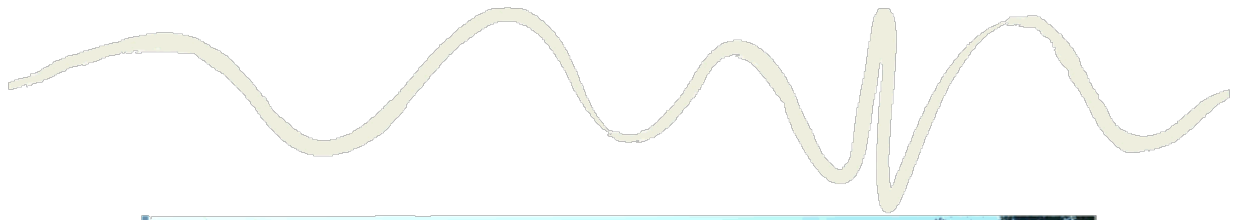

Photo 16 – CH 1,100 – View to the EAST – Intersection with eastern end of Cronulla Street



Photo 17 – CH 1,200 – View to the EAST – AUR for the intersection with Suvla Street



Photo 18 – CH 1,300 – View to the EAST – Intersection with Suvla Street



Road Safety Audit – Section A: HillStreet/Pine Avenue/The Coast Road
3586-1010

7.4 **Traffic Issues, Hill Street/Pine Avenue/The Coast Road, East Ballina (Section A) – Road Safety Audit**

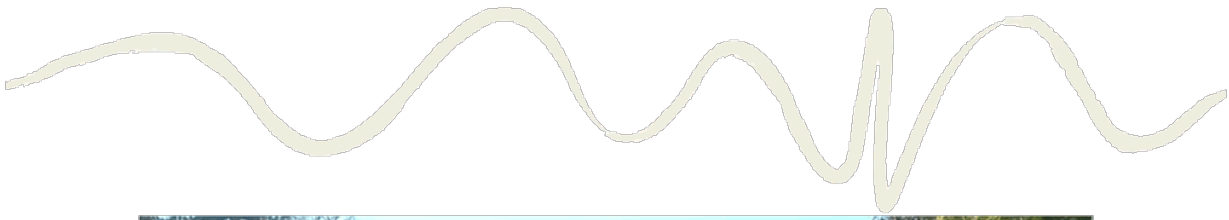

Photo 19 – CH 1,400 – View to the EAST – End of AUL for intersection with Suvla Street



Photo 20 – CH 1,500 – View to the EAST – End of 60 km/h zone



Road Safety Audit – Section A: HillStreet/Pine Avenue/The Coast Road
3586-1010

7.4 **Traffic Issues, Hill Street/Pine Avenue/The Coast Road, East Ballina (Section A) – Road Safety Audit**

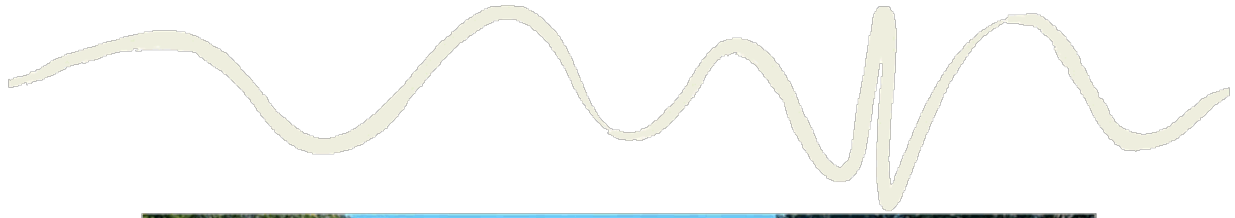

Photo 21 – CH 1,500 – View to the WEST – Start of 60 km/h zone



Photo 22 – CH 1,400 – View to the WEST – Start of CHL and end of AUR for Suvla Street intersection



Photo 23 – CH 1,350 – View to the WEST – Intersection with Suvla Street



Road Safety Audit – Section A: HillStreet/Pine Avenue/The Coast Road
3586-1010

7.4 Traffic Issues, Hill Street/Pine Avenue/The Coast Road, East Ballina (Section A) – Road Safety Audit



Photo 24 – CH 1,300 – View to the WEST – Reinforcing 60 km/h speed zone sign



Photo 25 – CH 1,200 – View to the WEST – Start of AUR for the intersection with Suvla Street



Photo 26 – CH 1,100 – View to the WEST – Intersection with eastern end of Cronulla Street



Road Safety Audit – Section A: HillStreet/Pine Avenue/The Coast Road
3586-1010

7.4 Traffic Issues, Hill Street/Pine Avenue/The Coast Road, East Ballina (Section A) – Road Safety Audit



Photo 27 – CH 1,000 – View to the WEST – Bus stop



Photo 28 – CH 950 – View to the WEST – Intersection with western end of Cronulla Street



Photo 29 – CH 925 – View to the WEST – Intersection with Manly Street



7.4 Traffic Issues, Hill Street/Pine Avenue/The Coast Road, East Ballina (Section A) – Road Safety Audit

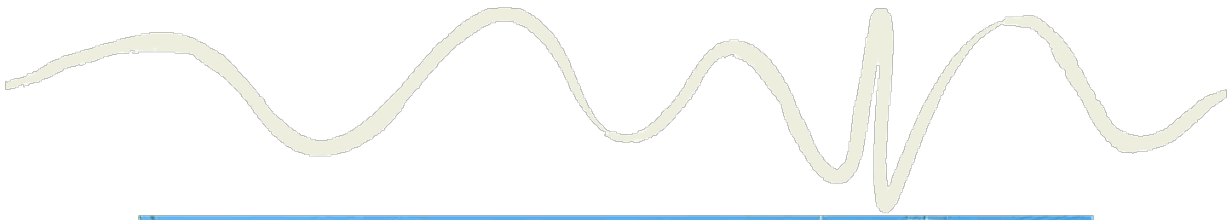

Photo 30 – CH 900 – View to the WEST – Intersection with Manly Street



Photo 31 – CH 850 – View to the WEST – Start of CHL for the intersection with Manly Street



Photo 32 – CH 750 – View to the WEST



Road Safety Audit – Section A: Hill Street/Pine Avenue/The Coast Road
3586-1010

7.4 **Traffic Issues, Hill Street/Pine Avenue/The Coast Road, East Ballina (Section A) – Road Safety Audit**



Photo 33 – CH 700 – View to the WEST



Photo 34 – CH 650 – View to the WEST – Intersection with Coogee Street



Photo 35– CH 500 – View to the WEST



Road Safety Audit – Section A: HillStreet/Pine Avenue/The Coast Road
3586-1010

7.4 Traffic Issues, Hill Street/Pine Avenue/The Coast Road, East Ballina (Section A) – Road Safety Audit

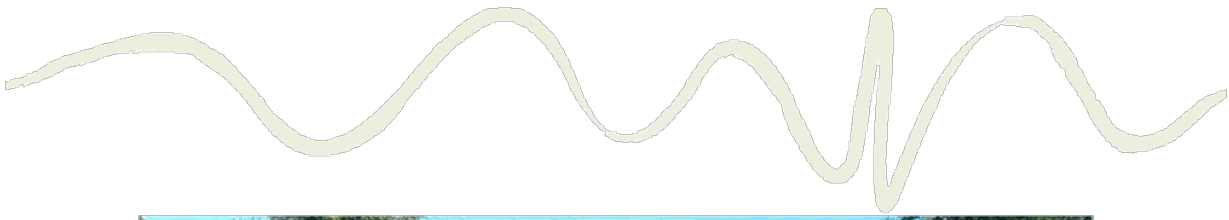

Photo 36 – CH 400 – View to the WEST – Intersection with Compton Drive



Photo 37 – CH 300 – View to the WEST – Bus stop and pedestrian refuge



Photo 38 – CH 250 – View to the WEST – Intersection with Brighton Street (left) and Park Street (right)



Road Safety Audit – Section A: Hill Street/Pine Avenue/The Coast Road
3586-1010

7.4 Traffic Issues, Hill Street/Pine Avenue/The Coast Road, East Ballina (Section A) – Road Safety Audit



Photo 39 – CH 150 – View to the WEST



Photo 40 – CH 75 – View to the WEST – Intersection with The Serpentine



Photo 41 – CH 0 – View to the WEST – East end of Missingham Bridge



Road Safety Audit – Section A: Hill Street/Pine Avenue/The Coast Road
3586-1010

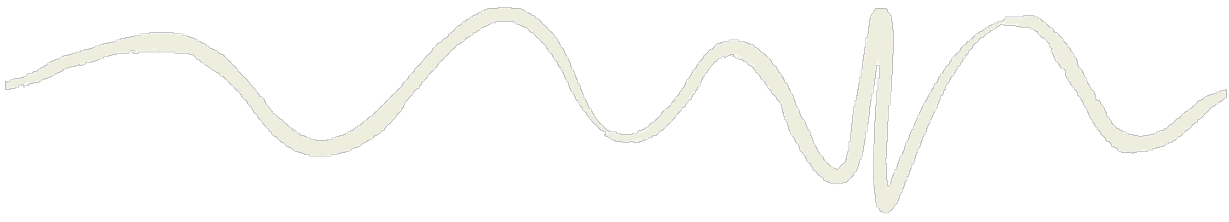

Appendix B

Correspondence from Local Residents



7.4 Traffic Issues, Hill Street/Pine Avenue/The Coast Road, East Ballina (Section A) – Road Safety Audit



Email 1

"With the closure of the parking in front of the Shaws bay hotel area recently by your counterparts , who by the way, have no idea what a debacle this is going to cause this long Australia Day weekend, we would like to bring to your attention the problems occurring across this whole area.

We believe that this is due to the increased traffic through this area over the last twelve months, caused in part due to the beaches popularity as well as the new cafe and coffee shop.

We live down range street and have had many near accidents due to the lack of clarity in regard to parking and the absence of any clear line markings across the whole area causing most visitors to not even realise that it is a road that carries quite a lot of traffic all year.

We believe that something must be done as soon as possible to improve the whole area to make it safer for all. At the very least , clear lane markings and traffic separators must be considered asap .

Also the corner in front of the coffee shop often gets blocked by vehicles parking on the bend , delivery trucks parked right on the corner for up to 30 mins making it extremely difficult to get in and out of range street, let alone seeing customers of both shops meandering all over the road.

It is a recipe for a disaster to happen at some time. I personally am amazed that nothing has happened to cause injury that I am aware of. The road surface is breaking up and has been patched up many times. In reality , the whole area has become an eyesore and a mess.

Please consider working with your counterparts responsible for the park area and fix the whole area at the one time."

Email 2.

"Hi, I am concerned about the parking / number of cars, especially in holiday periods, around the Shaws Bay Kiosk beach area. Has the Council considered at least making some of the parking 4 hourly to stop cars (who are most likely overflowing from the caravan park) being permanently parked so that day visitors have even less access to parking? I'm also concerned about the erosion that's occurring from 4WDs parking on the grass / sand in the area.

Another area that might need to be blocked off to cars is along the river (behind the Tourist information Centre). There's ample parking there but, since there's access, people drive there cars right up to the riverbank. This is also causing damage to the riverfront since it is so dry. There's no need for the cars to be parked on the riverbank when its such a short walk from the car park."

Email 3.

"I would like to draw your attention to the safety issues arising from the lack of separation between vehicle and pedestrian traffic on Pine Avenue and Hill Street East Ballina. The section I am referring to is between the Suvla Street and Crompton Drive intersections.

Extensive road works were completed some years ago that resulted in the formed footpath being constructed hard against the southbound traffic lane. With the development north of Ballina this road is extremely busy especially during the morning and afternoon 'peak' periods and weekends. The speed limit on this road is still 60km an hour which seems excessive when cars, trucks and buses are passing pedestrians only separated by the width of the gutter.

I appreciate that this is not a straight forward problem to fix. Because there is no parking lane or allocation on this section of road a large percentage of the gutter length is layback to allow vehicle access to the residential properties. This precludes the use of a physical barrier such as guard rails to separate vehicles and pedestrians as we have on Missingham bridge and adjacent to the Crompton Drive intersection.



Road Safety Audit – Section A: HillStreet/Pine Avenue/The Coast Road
3586-1010

7.4 Traffic Issues, Hill Street/Pine Avenue/The Coast Road, East Ballina (Section A) – Road Safety Audit

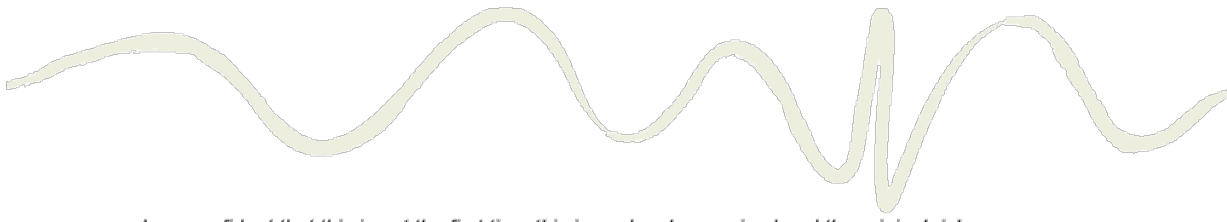

I am confident that this is not the first time this issue has been raised and the original risk assessments associated with the road construction would have identified this design as having significant safety implications for pedestrians. I would ask you to urgently consider a reduction in the speed limit while other measures such as traffic calming and speed limit enforcement are evaluated."

Email 4

"Over the past few months the parking around Shaw's Bay in Brighton Street has increased to a point that it is now dangerous and also becoming very inconvenient to all of the residents in Range Street.

On weekends, public and school holidays and Monday mornings, overflow traffic and parking from the hotel, shops, and the beach is at times blocking the street. Shop truck deliveries have blocked the street for up to 10 to 15 minutes, with the drivers refusing to move " because they will only be a few minutes". If there was any emergency this is not acceptable, as residents cannot get in or out.

Parking in Range Street on Sundays is stopping residents from placing garbage bins, street-side for Monday morning pickup. Last week I had been told the garbage truck had to return at a later time because Sunday " left over parking" was still blocking the street that Monday morning. Could we have NO STANDING signs installed on the southern side of Range Street?

The access to Brighton Street off Compton Drive has become dangerous as well. I have brought this to the Council attention before.

Cars, 4WD's and trucks, and Byron Bay surf schools are coming down Compton Drive and NOT turning into Brighton Street but driving straight across the intersection, into what WAS the park.

Unfortunately this is now an eroded dust bowl, from all the vehicle traffic and parking. I have nearly been hit by a car doing this and some of our neighbors have told me of similar incidents. At Christmas this year I witnessed a young child run out from behind the phone booth, nearly hit by a large 4WD, which came directly off Compton Drive. This park needs to be fenced off and dividing median strip built at the intersection to force drivers to turn in safely, before someone is injured or worse."

Email 5

"I have been concerned for some time about the complete disregard by drivers exiting Crompton Drive onto Hill St @ Shaw's Bay.

I am very concerned for the safety of drivers coming down Hill St and am worried about a serious accident occurring at the location where the two streets intersect. There is a stop sign on the corner of Crompton which on many occasions is completely ignored. I live @ East Ballina and to drive to town I only have 2 options Missingham bridge or via E/B and Angles Beach Drive.

When Southern Cross high school was in operation I drove a school bus (which most days was fully loaded) from SCHS to the interchange @ the old Ballina High school via Links Ave and Hill St Missingham etc. on most occasions I would have to brake heavily to avoid a collision with vehicles shooting out of Crompton drive without observing the stop sign.

Yesterday I decided that I had had enough as I was driving down Hill St in my own car a vehicle shot out of Crompton with no reduction of speed I had to brake heavily to avoid a collision. So I noted the registration of the vehicle and drove straight to the police station to report the incident. The officer at reception told me that there was nothing they could do as they did not witness the event, and that I should report it to the council, which is what I am now doing.

Something needs to be done before somebody is injured or even killed."



Road Safety Audit – Section A: HillStreet/Pine Avenue/The Coast Road
3586-1010

7.4 Traffic Issues, Hill Street/Pine Avenue/The Coast Road, East Ballina (Section A) – Road Safety Audit

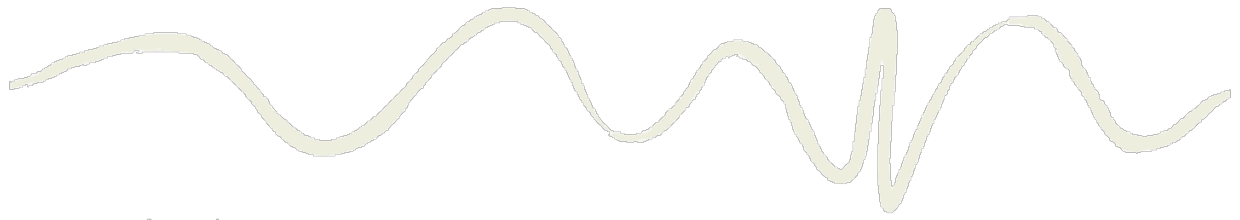

Letter 1

I BELIEVE THERE IS A SERIOUS PROBLEM AT THE ENTRANCE TO THE SHAW'S BAY (BRIGHTON ST) OFF HILL STREET.

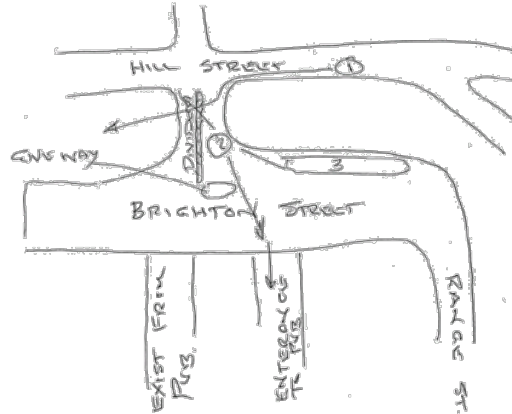

1) CARS COMING DOWN HILL STREET CUT ACCESS TO ENTRANCE TO SHAW'S BAY ONTO THE GRASS AREA, NOT GIVING WAY

2) CARS TURNING INTO THE HOTEL (AT PRIVATE DRIVEWAY) DO NOT GIVE WAY TO TRAFFIC ON BRIGHTON STREET

3) CAR PARKED AT (3) CUT ACCESS TO ENTRANCE TO EAST

I FEEL THERE NEED AS DIVIDER AT (A) WITH A GIVING WAY SIGN.



Letter 2

Dear Sir,

I am writing to express concern about a couple of parking matters.

Firstly, for some years there has been a problem over the Christmas school holidays with parking in the area between the Caravan Park at Shaws Bay and the approach to the Missingham Bridge. This problem is apparently caused by the Caravan Park limiting the number of vehicles, patrons can park inside the Caravan Park, causing them to park semi-permanently as close as possible outside the park. The little beach (where the fishermen net sea mullet) is an extremely popular spot for people with very young children and also for older bathers who wish to avoid being buffeted by the surf. Our daughter and 8 month old grandson were with us for Christmas and January and found it extremely difficult to get a parking spot even in the area across the road towards the Serpentine. People with babies need to carry prams or strollers and nappy bags etc and this is difficult over long distances. This problem would seem to be able to be remedied by the introduction of timed parking spots along the foreshore and the prohibition of long term parking east of Pine Street. This would need to be regulated by the Council's parking ranges.

The other area of concern is people parking on the footpath on the east side of Pine Street. This is a problem all year round but also seems worse during the holidays when rental properties there attract numerous vehicles. Parking on the footpath means that pedestrians, skateboarders, scooter riders, cyclists and mobility scooters have to venture onto the very busy road to avoid cars on the footpath. I realise that parking is a difficult issue for residents and tradesmen, but extended parking on the footpath is not an acceptable solution. I also realise that this may be more of a police matter rather than a Council matter and request (if this is the case) that you bring this matter to the attention of the Traffic Committee as it is a real safety concern. In the last two weeks I have had to brake sharply to avoid a cyclist and a skateboarder on two separate occasions.

Safe System Assessment

Section A: Hill St/Pine Ave/The Coast Road

1.5km of Existing Road in East Ballina

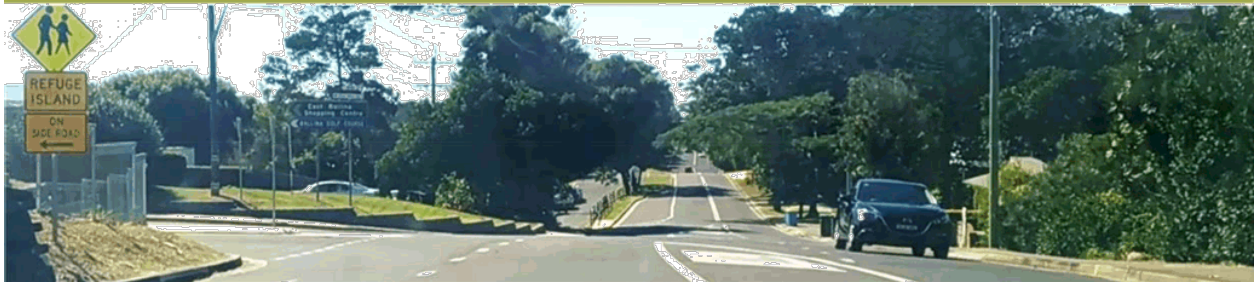

PO Box 119
Lennox Head NSW 2478
T 02 6687 7666

PO Box 1446
Coffs Harbour NSW 2450
T 02 6651 7666

PO Box 1267
Armidale NSW 2350
T 02 6772 0454

PO Box 229
Lismore NSW 2480
T 02 6621 6677

info@geolink.net.au

Prepared for: Ballina Shire Council
© GeoLINK, 2020

7.4 Traffic Issues, Hill Street/Pine Avenue/The Coast Road, East Ballina (Section A) – Road Safety Audit

<i>UPR</i>	<i>Description</i>	<i>Date Issued</i>	<i>Issued By</i>
3586-1005	First issue	01/06/2020	MVE

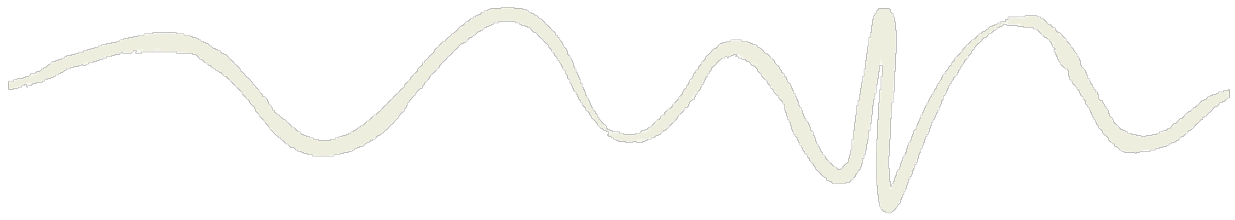

Table of Contents

1.	Project Information	1
1.1	Background	1
1.2	Site Description	1
1.3	RSA Findings	4
2.	Safe System Assessment	5
2.1	Safe System Assessment Framework (SSAF)	5
2.2	Safe System Matrix	6
3.	Conclusions	10

Tables

Table 1.1	Intersections within the study area	3
Table 1.2	RSA findings and accepted actions	4
Table 2.1	Project context	6
Table 2.2	Safe System Assessment Matrix – Existing	8
Table 2.3	Safe System Assessment Matrix – Upgraded to implement accepted actions	9

Figures

Figure 1.1	Site Locality	2
Figure 1.2	Site Detail	2
Figure 2.1	The Safe System	5

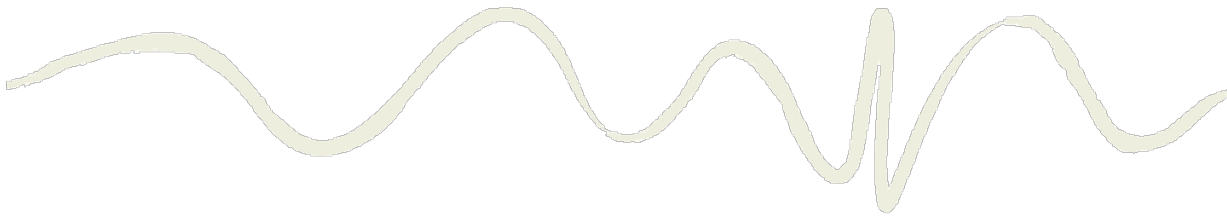

1. Project Information

1.1 Background

Ballina Shire Council (Council) has engaged GeoLINK to undertake Road Safety Audits (RSA) and Safe System Assessments (SSA) for existing roads and road-related areas in the East Ballina/Shaws Bay area. This report is for Section A, being 1.5 km of existing road, including intersections, extending from the eastern end of Missingham Bridge to the change in speed zone from 60 km/h to 80 km/h. This stretch of road changes name twice and is known (from west to east) as Hill Street, Pine Avenue and The Coast Road.

A separate RSA and SSA has been undertaken for Section B, including part of Hill Street which falls in the scope of this assessment. In addition to the intersection of Hill Street and Park Street/Brighton Street, Section B also comprises the area to the east including Brighton Street, Range Street and the publicly accessible road-related areas providing access and parking (formal and informal) to the nearby take-away shops, amenities block, caravan park and Shaws Bay Hotel.

This report details the process and outcomes of the SSA for Section A which has been carried out following completion of the RSA for both Sections A and B.

1.2 Site Description

Council has provided the following description of the site:

Hill St/Pine Ave/The Coast Rd is part of a significant connector road that connects the east end of Ballina CBD via Kingsford Smith Drive, Hill Street, Pine Avenue and The Coast Road northwards to Angels Beach, Skennars Head and Lennox Head. Traffic volumes in 2014 were 4,079 vehicles per day and modelled to reach 4,662 by 2036. Hill St/Pine Ave traverses a constrained hilly section of East Ballina that is characterised by medium and low-density housing on the east [north] side and lower density housing and some natural areas on the west [south] side. Due to topographical and cost constraints, Hill St/Pine Ave is quite narrow with no provision for kerbside parking.

The study area begins at the western end as Hill Street (chainage 0). At chainage 650 m, beyond the intersection with Coogee Street, Hill Street becomes Pine Avenue. Another 650 m east at the intersection with Suvla Street, it becomes The Coast Road. The change in speed zone is a further 200 m east of the Suvla Street intersection. The speed zone within the study area is 60 km/h. The speed zone is delineated by 60 km/h speed signs at either end of the speed zone plus intermediate reinforcing speed zone signs (once in the eastbound direction following Missingham Bridge and twice in the westbound direction following the Suvla Street and Compton Drive intersections).

The existing road pavement and surface appears to be in good condition.

There is some street lighting along the length of the study area and numerous power poles with overhead power lines.

Figure 1.1 overleaf shows the whole stretch of Section A, and **Figure 1.2** shows the detail of the south western end of the site (Section B).

7.4 Traffic Issues, Hill Street/Pine Avenue/The Coast Road, East Ballina (Section A) – Road Safety Audit

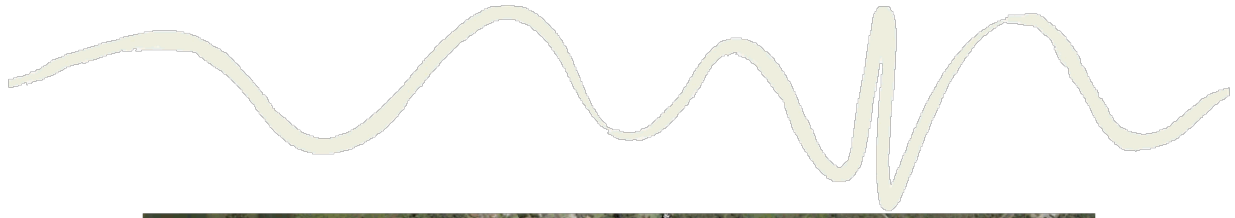

Figure 1.1 Site Locality [Source: SIX Maps]



Figure 1.2 Site Detail [Source: SIX Maps]



7.4 Traffic Issues, Hill Street/Pine Avenue/The Coast Road, East Ballina (Section A) – Road Safety Audit

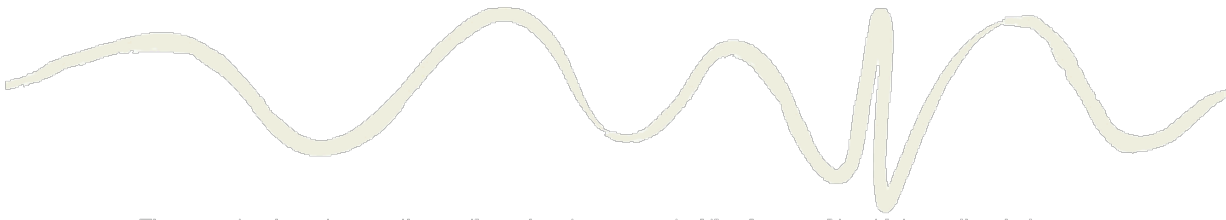

There are two bus stops on the eastbound route: one east of the Coogee Street intersection, between the two Cronulla Street intersections; and one on the westbound route sharing the informal channelised left turn lane into Brighton Street.

The route provides good connectivity for pedestrians and cyclists with sections of shared path and non-shared paths (i.e. < 2.5m in width) between nearby residences, commercial premises, amenities, beaches and recreational area. There are two pedestrian refuge islands: one between the Brighton Street/Park Street and Compton Drive intersections and the other at the tangent point of the Compton Drive intersection.

The study area includes several intersections with varying significance and treatments. Details of the intersections are noted below.

Table 1.1 Intersections within the study area

Street name	Location*	Turn Treatment	
The Serpentine	60 m N	CHL	Prohibited
Park Street	240 m N	CHL	BAR
Brighton Street	240 m S	Informal CHL shared with bus bay	AUR
Compton Drive	350 m S	BAL	Prohibited
Coogee Street	650 m N	BAL	BAR
Manly Street	900 m N	CHL	CHR
Cronulla Street, west	1,000 m N	BAL	BAR
Cronulla Street, east	1,100 m N	BAL	BAR
Suvia Street	1,300 m S	CHL	AUR

NOTES:

- Location is measured in metres west of the eastern end of Missingham Bridge
- 'N' or 'S' refers to which side (north or south) of Hill St/Pine Ave/The Coast Rd the side street extends
- CHL and CHR denote channelised left/right turn lane
- BAL and BAR denote basic left/right turns
- AUR refers to an auxiliary right turn lane.

The site, particularly the western end between Missingham Bridge and Compton Drive is known to be popular with locals and visitors with an influx of beach-goers, holidaymakers and patrons to the Shaws Bay Hotel on weekends during the summer months and school holidays. This area is the focus of the separate assessment carried out for Section B.

Photos of the site taken from video footage recorded on Sunday the 26th of April 2020, along with crash history data and letters sent to Council by concerned local residents are provided with the RSA for Section A.

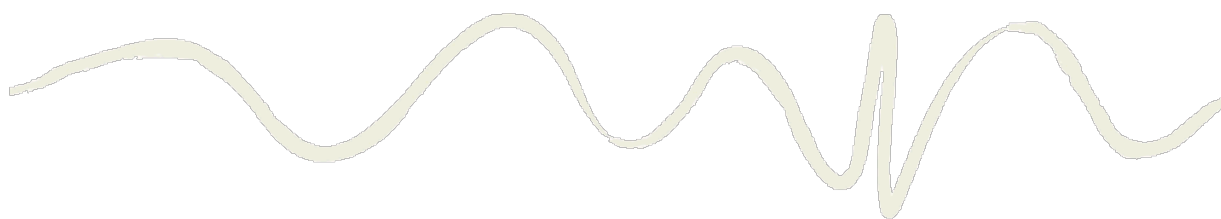

1.3 RSA Findings

The existing site RSA carried out for Section A identified a number of deficiencies, providing each with a risk rating. The findings and recommendations accepted by Council are summarised below.

Table 1.2 RSA findings and accepted actions

Audit finding	Actions
1.1, 1.3, 1.4, 4.1, 4.4	Council will consider options to reconfigure the intersection of Hill Street / Park Street / Brighton Street in conjunction with the area to the east of Brighton Street with the aims to: <ul style="list-style-type: none"> ▪ Provide a right turn lane for traffic turning right off Hill Street into Brighton Street; ▪ Relocate the bus zone to avoid conflict with the left turn lane from Hill Street to Brighton Street and prevent buses from obscuring the view of motorists existing Brighton Street; ▪ Provide better connectivity for pedestrians to cross Hill Street, particularly between Missingham Bridge and the Park Street/Brighton Street intersection; ▪ Provide better pedestrian connectivity through the Brighton Street area; and ▪ Improve street lighting.
1.2, 3.2, 3.3	Clean and/or replace the 'Concealed Driveways Ahead' sign on Pine Avenue (westbound traffic) and install a similar sign appropriately located on Hill Street for eastbound traffic.
1.2, 1.5, 1.7, 3.2, 3.3, 4.4, 5.2	Apply to TfNSW for a speed zone review with the intention to gain approval to reduce the speed zone from 60 km/h to 50 km/h for the full length of the study area, thus improving the safety associated with following by reducing the likelihood and/or severity of a crash: <ul style="list-style-type: none"> ▪ Property access on the south side of Hill Street / Pine Avenue; ▪ Turning manoeuvres at the Hill Street / Compton Drive intersection; ▪ The narrow carriageway on Hill Street; ▪ The concealed driveways on Pine Avenue; ▪ Pedestrians crossing the road carriageway; and ▪ Any errant vehicle collision.
3.1	Refresh and maintain linemarking.
3.4	Repair 'Shared Path' sign on the south eastern corner of the Hill / Brighton Street intersection.
4.2, 4.3	Improve shared path networks east and south of Compton Drive as part of the next review of Council's Pedestrian and Access Mobility Plan (PAMP). However, it is likely that only low-cost solutions will be possible in the near future. <i>For the purpose of the SSA, it is assumed that only improvements associated with the upgrade of Section B will be made in relation to pedestrian facilities.</i>
4.5	The intention and appropriateness of the timber board fixed to the rear of the guard rail on the south west corner of the Hill Street / Compton Drive intersection will be investigated and compliance checked against current relevant standards.
5.1	All roadside vegetation will be monitored and maintained to ensure signage is visible and intersection sight distance is maximised.

Note that audit findings are colour coded according to the risk ranking determined in the RSA for the design as per the concept design plans: Low, Medium, High. Note also that these rankings are likely to improve (i.e. drop) with application of the agreed actions tabled above.

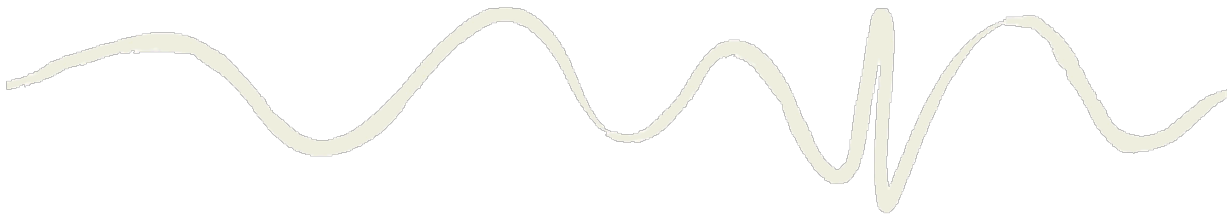

2. Safe System Assessment

2.1 Safe System Assessment Framework (SSAF)

The 'Safe System' (SS) approach is an internationally recognised holistic methodology. The key principles underpinning the SS approach are:

- People make mistakes. Humans will continue to make mistakes, and the transport system must accommodate these. The transport system should not result in death or serious injury because of errors on the roads.
- Human physical frailty. There are known physical limits to the amount of force our bodies can take before we are injured.
- A 'forgiving' road transport system. A SS ensures that the forces in collisions do not exceed the limits of human tolerance. Speeds must be managed so that humans are not exposed to impact forces beyond their physical tolerance. System designers and operators need to consider the limits of the human body in designing and maintaining roads, vehicles and speeds.
- Inclusive view of the whole road transport system and the interactions between all elements: roads and roadsides, vehicles, travel speeds and all users of the system.

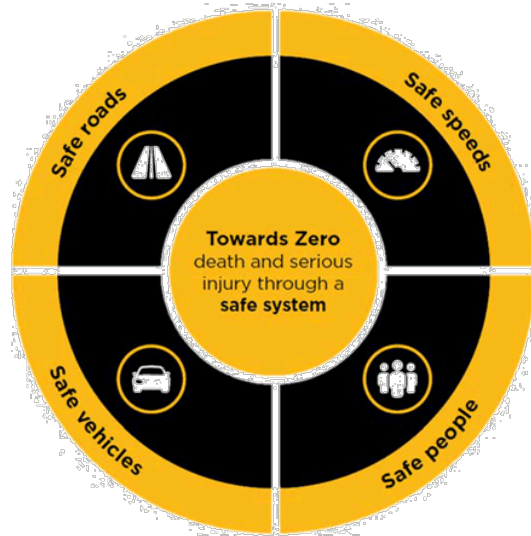

Figure 2.1 The Safe System
[Source: Transport for NSW, 2018]

SS principles recognise that human error in the road environment is inevitable and that road infrastructure should accommodate this error and minimise the consequences. The aim is to eliminate any crash resulting in a fatality or serious injury (FSI) by implementing:

- Safer roads;
- Safer vehicles;
- Safer road users; and
- Safer speeds.

The *National Road Safety Strategy 2011-2020* (Australian Transport Council, 2011) and the *NSW Road Safety Strategy 2012-2021* (Transport for NSW, 2012) outline a commitment to the adoption and implementation of the SS approach. As a result of this, it is now expected that road safety processes and procedures, including RSAs, be implemented to ensure a high alignment with the SS principles.

While RSAs are proven to reduce road trauma (AGRS06, 2019), they have traditionally focused on a safety-in-design approach and identifying risks and hazards associated with all crash types and severities. However, the SS approach aims to prioritise eliminating FSI crashes.

The SSAF was developed by Austroads to facilitate the incorporation of SS objectives in all road infrastructure and traffic management projects. A SSA is a proactive tool within the framework which

7.4 Traffic Issues, Hill Street/Pine Avenue/The Coast Road, East Ballina (Section A) – Road Safety Audit

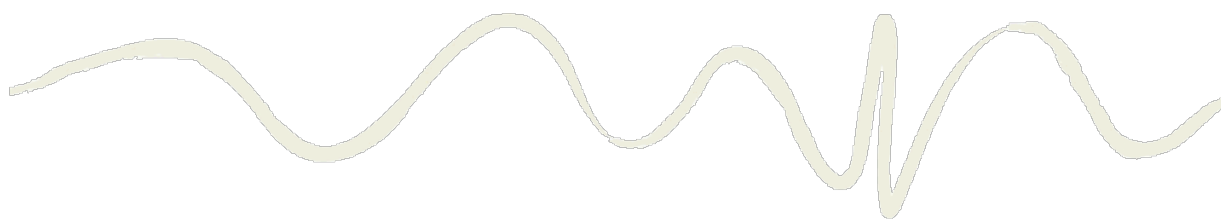

uses a matrix to ensure consistent consideration of major crash types and prompts an assessment of crash severity, road user exposure and crash likelihood as they apply to each crash type. It can be carried out on a wide variety of project types and at any stage across the lifespan of a project (planning, design, operation and maintenance).

The main stages of the SSAF are:

- Identification of objectives;
- Setting the context;
- Applying the SS matrix; and
- Applying a treatment hierarchy and selection process (not required for this assessment).

The depth of assessment and analysis in a SSA should reflect the project size, complexity and risk of FSI crashes.

The intention of identifying the project context as per **Table 2.1** is to ensure that each aspect of the SS is considered as part of the system (refer **Figure 2.1**).

Table 2.1 Project context

Prompt	Comments
Reason for the project	Improve safety, efficiency and amenity on Hill Street, Pine Avenue and The Coast Road within the study area.
Function of the road	Collector road, part of alternative arterial road between Lennox Head and Ballina
Speed environment	60km/h as signposted.
Road users	Commuters, service vehicles, tourists, picnic/beach-goers, sports and recreation, parents doing school run, school/public buses, pedestrians, cyclists.
Vehicle composition	Motor vehicle traffic, including motorcyclists, with very low percentage of heavy vehicles Pedestrians and cyclists using off-road pathways, some cyclists using vehicle travel lanes

2.2 Safe System Matrix

In order to ensure that SS elements are considered, or to measure how well a given project aligns with SS principles, a SS matrix has been produced. The purpose of the matrix is to assess major crash types identified as the predominant contributors to FSI outcomes against the exposure to that crash risk, the likelihood of it occurring and the severity of the crash should it occur.

Exposure, likelihood and severity (the rows of the matrix) are defined by Austroads as follows:

- **Road user exposure:** this refers to which road users, in what numbers and for how long they are using the road and are thus exposed to a potential crash. The measures of exposure include AADT, side-road traffic volumes, number of motorcycles, cyclists and pedestrians crossing or walking along the road, length of the road, area and length of time.
- **Crash likelihood:** groups of factors affecting the probability of a crash occurring. They can be elements which moderate opportunity for conflict, such as the number of conflict points, offset to roadside hazards, and separation between opposing traffic. They can also include elements of road user behaviour and/or road environment. Typically, these are the elements which moderate road user error rates. This includes issues such as level of intersection control (e.g.

7.4 Traffic Issues, Hill Street/Pine Avenue/The Coast Road, East Ballina (Section A) – Road Safety Audit



priority/signals/movement ban), speed, sight distance, geometric alignment, driver guidance and warning, and maintenance.

- **Crash severity:** groups of factors affecting the probability of severe injury outcomes should a crash occur. Typically, these factors are associated with the amount of kinetic energy and its transfer in the crash, e.g. impact speeds and angles, severity of roadside hazards.

The matrix columns show the following major crash types:

- Run-off-road (also referred to as 'loss of control', or 'off path on curve/straight')
- Head-on (or 'vehicles from opposing directions')
- Intersection ('vehicles from adjacent directions')
- Other (this incorporates all same direction, manoeuvring, overtaking, on path and other crashes)
- Pedestrian
- Cyclist
- Motorcyclist

A score between zero and four (0-4) is subjectively determined for each cell based on site specific information available at the time of assessment. Zero indicates full alignment with the SS objectives for that component of the risk (exposure, likelihood or severity) for the given crash type or the absence of that category (e.g. no pedestrians). The higher the score, the further away the project is from SS principles. Comments providing a rationale for each score are also provided where deemed appropriate.

Once a score is provided in each cell, the product of each column is calculated and entered in the final row. The purpose of this multiplicative approach is that if a score of zero has been given for any component of a crash type (i.e. exposure, likelihood or severity), that crash type receives a total of zero and is eliminated from the score (as it has reached a SS condition).

The Austroads guidelines suggest that a project with a crash type score of less than 16 can be considered highly-aligned with the SS for that crash type. A design can be considered moderately-aligned between 16 and 32, and poorly-aligned above 32.

The sum of the scores for each crash type is added to calculate the total SSAF score out of a possible 448. It represents the contribution of 'safe speeds' and 'safe roads/roadsides' to the SS for the project.

Total SSAF scores of less than 112 are considered highly-aligned, 112 to 224 are considered moderately-aligned, and above 224 are considered poorly-aligned.

The focus of the SS matrix is on the assessment of infrastructure, and as such, more attention is given to road and roadside infrastructure and vehicle speeds. The road users and vehicle types involved are also considered along with post-crash care, however in many cases, road user and vehicle-related changes will be outside the scope of the project.

A SS Assessment Matrix has been prepared for the existing study area (

Table 1). It has then been reproduced to reassess the same area assuming all actions listed in **Table 1.3** are executed to achieve their aim, thus allowing comparison of the 'before' and 'after' scenarios.

The second matrix,

Table 2., highlights in **red** where the assessment differs from the baseline (existing) case.

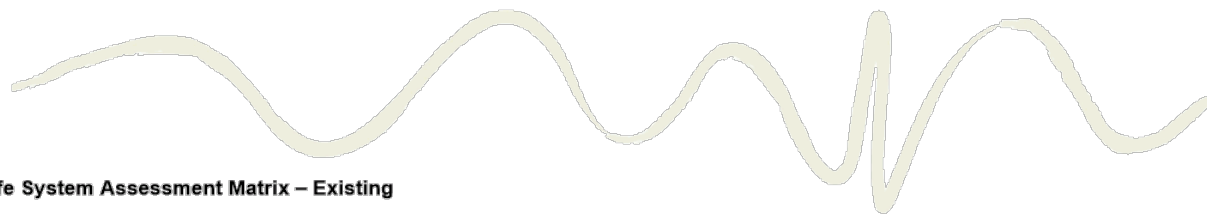

Table 2.2 Safe System Assessment Matrix – Existing

	<i>Run-off-road</i>	<i>Head-on</i>	<i>Intersection</i>	<i>Other</i>	<i>Pedestrian</i>	<i>Cyclists</i>	<i>Motorcyclist</i>
<i>Road User Exposure</i>	2 / 4	2 / 4	2 / 4	2 / 4	4 / 4	4 / 4	2 / 4
<i>Crash Likelihood</i>	3 / 4	3 / 4	3 / 4	3 / 4	3 / 4	3 / 4	3 / 4
<i>Crash Severity</i>	3 / 4	3 / 4	3 / 4	3 / 4	4 / 4	4 / 4	3 / 4
Product	18 / 64	18 / 64	18 / 64	18 / 64	48 / 64	48 / 64	18 / 64

Total SSAF Score = 186 / 448

Additional SS Component	Comment
<i>Road users</i>	<ul style="list-style-type: none"> ▪ High volume of all road user groups. ▪ Road users likely to be alert and compliant due to proximity to roundabout west of Missingham Bridge and roundabout at Angels Beach Drive. ▪ Numerous distractions in roadside environment – signs, advertising, pedestrians etc. ▪ Frequently changing carriageway cross section. ▪ Proximity to Shaws Bay Hotel may result in drunk drivers and/or pedestrians using the road. ▪ Highly popular area for families with young children. ▪ Pedestrians observed crossing illegally. ▪ Confusing layout and unclear priorities east of Hill Street / Brighton Street intersection. ▪ Special road users may include travellers – unfamiliar with the area and likely to be unpredictable.
<i>Vehicles</i>	<ul style="list-style-type: none"> ▪ Very low percentage of heavy vehicles. ▪ Existing roadway in good condition, except east of Hill Street / Brighton Street, where roadway is in very poor condition. ▪ Parking areas informal and confusing. ▪ Through vehicles observed treating the area as a 'main road'. 60 km/h speed zone potentially sending wrong message to road users.
<i>Post-crash care</i>	<ul style="list-style-type: none"> ▪ Single lane each way, narrow carriageway (esp. between Compton Drive and Manly Street), thus difficult for emergency vehicles to access. ▪ Hospital and ambulance/fire/police stations all located in Ballina (2-5km travel distance). ▪ Westpac Life Saver Rescue Helicopter operates in the area. ▪ VMS (variable message signs) available for deployment and broadcasts on local radio stations possible to warn road users of an incident.



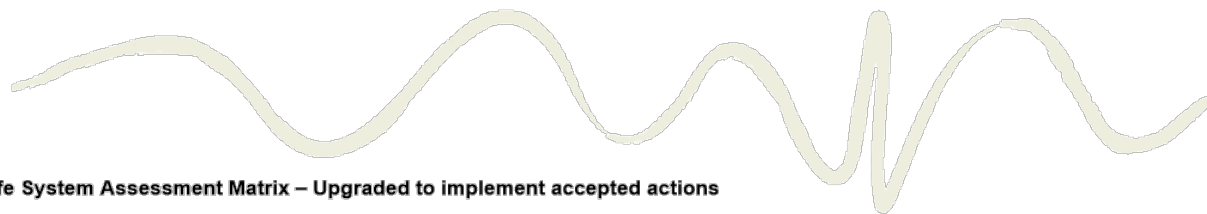

Table 2.3 Safe System Assessment Matrix – Upgraded to implement accepted actions

	<i>Run-off-road</i>	<i>Head-on</i>	<i>Intersection</i>	<i>Other</i>	<i>Pedestrian</i>	<i>Cyclists</i>	<i>Motorcyclist</i>
<i>Road User Exposure</i>	2 / 4	2 / 4	2 / 4	2 / 4	4 / 4	4 / 4	2 / 4
<i>Crash Likelihood</i>	3 / 4	3 / 4	2 / 4	2 / 4	2 / 4	2 / 4	2 / 4
<i>Crash Severity</i>	2 / 4	2 / 4	2 / 4	2 / 4	4 / 4	3 / 4	3 / 4
Product	12 / 64	12 / 64	8 / 64	8 / 64	32 / 64	24 / 64	12 / 64

Total SSAF Score = 108 / 448

Additional SS Component	Comment
<i>Road users</i>	<ul style="list-style-type: none"> ▪ High volume of all road user groups. ▪ Road users likely to be alert and compliant due to proximity to roundabout west of Missingham Bridge and roundabout at Angels Beach Drive. ▪ Numerous distractions in roadside environment – signs, advertising, pedestrians etc. ▪ Improved road environment due to reconfiguration of Hill Street and intersections between Missingham Bridge and Compton Drive, particularly formalising the area east of the Hill Street / Brighton Street intersection. ▪ Proximity to Shaws Bay Hotel may result in drunk drivers and/or pedestrians using the road. ▪ Highly popular area for families with young children. ▪ Pedestrians observed crossing illegally. However, improvements to pedestrian connectivity and facilities encourage better behaviour. ▪ Special road users may include travellers – unfamiliar with the area and likely to be unpredictable. ▪ Reduced speed zone improves safety by reducing livelihood and/or severity of some crash types.
<i>Vehicles</i>	<ul style="list-style-type: none"> ▪ Very low percentage of heavy vehicles. ▪ Existing roadway in good condition, esp. following future upgrade works. ▪ Parking areas formalised and improved. ▪ 50 km/h zone more appropriate for adjacent land uses and high pedestrian activity area. Gives message to road users that it is a local road.
<i>Post-crash care</i>	<ul style="list-style-type: none"> ▪ Single lane each way, narrow carriageway (esp. between Compton Drive and Manly Street), thus difficult for emergency vehicles to access ▪ Hospital and ambulance/fire/police stations all located in Ballina (2-5km travel distance). ▪ Westpac Life Saver Rescue Helicopter operates in the area. ▪ VMS (variable message signs) available for deployment and broadcasts on local radio stations possible to warn road users of an incident.



3. Conclusions

The existing 1.5 km section along Hill Street, Pine Avenue and The Coast Road described herein as Section A is found to be moderately aligned with the Safe System Assessment Framework in accordance with the relevant Austroads road safety guidelines (2019) and the Austroads research report, *Safe System Assessment Framework* (2016).

The existing 1.5 km section of road achieves a SSAF score of 186 out of 448.

The assessment carried out for the proposed upgrade works including the accepted recommendations proposed by the RSA and listed in Table 1.2 RSA findings and accepted actions **Table 1.2** of this report indicates that the proposal will improve the safety of the study area, yielding a score of 108 out of 448, which is considered to be highly aligned with the SSAF.

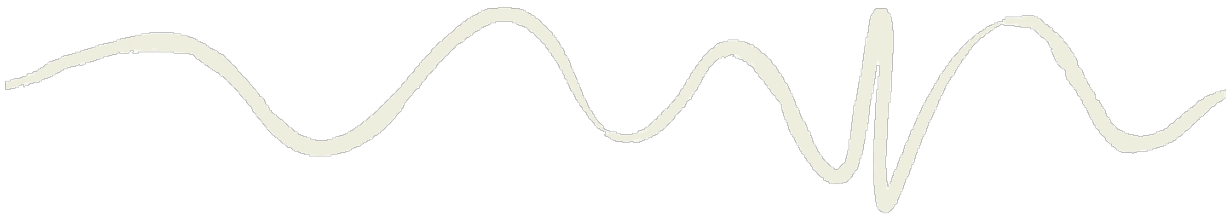

Copyright and Usage

©GeoLINK, 2020

This document, including associated illustrations and drawings, was prepared for the exclusive use of Ballina Shire Council. It is not to be used for any other purpose or by any other person, corporation or organisation without the prior consent of GeoLINK. GeoLINK accepts no responsibility for any loss or damage suffered howsoever arising to any person or corporation who may use or rely on this document for a purpose other than that described above.

This document, including associated illustrations and drawings, may not be reproduced, stored, or transmitted in any form without the prior consent of GeoLINK. This includes extracts of texts or parts of illustrations and drawings.

Road Safety Audit

Section B: Hill/Park/Range Streets

Existing Access and Parking Areas in Shaws Bay



PO Box 119
Lennox Head NSW 2478
T 02 6687 7666

PO Box 1446
Coffs Harbour NSW 2450
T 02 6651 7666

PO Box 1267
Armidale NSW 2350
T 02 6772 0454

PO Box 229
Lismore NSW 2480
T 02 6621 6677

info@geolink.net.au

Prepared for: Ballina Shire Council
© GeoLINK, 2020

7.5 Traffic Issues, Hill Street/Brighton Street/Range Street/Shaws Bay Hotel and Caravan Park Entrances Area (Section B) - Road Safety Audit

<i>UPR</i>	<i>Description</i>	<i>Date Issued</i>	<i>Issued By</i>
3586-1004	First issue	22/05/2020	MVE
3586-1011	Section issue	27/05/2020	MVE

7.5 Traffic Issues, Hill Street/Brighton Street/Range Street/Shaws Bay Hotel and Caravan Park Entrances Area (Section B) - Road Safety Audit

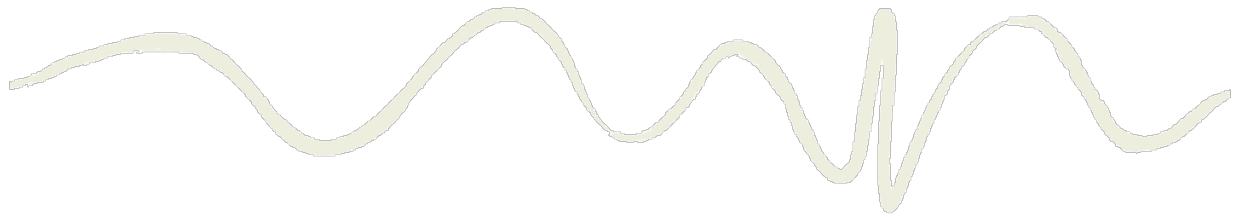

Table of Contents

1.	Project Information	1
1.1	Background	1
1.2	Site Description	2
1.3	Information Provided by the Client	3
1.4	Audit Scope	3
1.5	Audit Team	4
2.	Audit Process	5
2.1	Methodology and Responsibilities	5
2.2	Previous Audits	5
2.3	Commencement Meeting	5
2.4	Site Inspections	6
2.5	Completion Meeting	6
3.	Risk Matrix	7
4.	Audit Findings	8
5.	Recommendations	13
6.	Concluding Statement	14
6.1	Identified Deficiencies	14
6.2	Responding to the Audit	14
6.3	Concluding Statement	14

Tables

Table 2.1	Steps and responsibilities	5
Table 3.1	How often is the problem likely to lead to a crash?	7
Table 3.2	What is the likely severity of the resulting crash type?	7
Table 3.3	Resulting level of risk	7
Table 3.4	Treatment approach	7
Table 4.1	Audit findings	8
Table 5.1	Recommendations for client consideration to improve road safety	13

Figures

Figure 1.1	Site Locality [Source: SIX Maps]	1
Figure 1.2	The Site [Source: SIX Maps]	2

Appendices

- Appendix A Site Photos
- Appendix B Draft Design Provided by Council
- Appendix C Correspondence from Local Residents
- Appendix D Recommended Site Reconfiguration Options



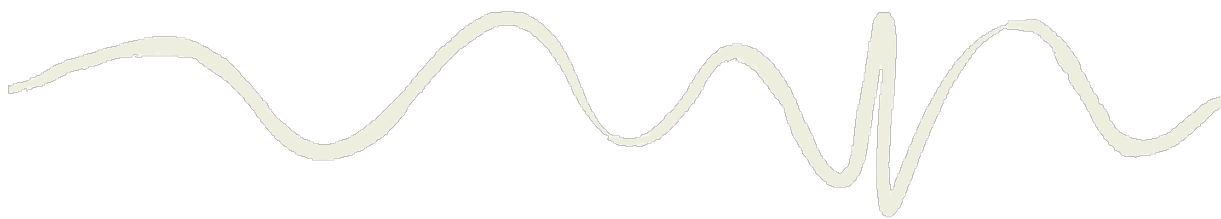

1. Project Information

1.1 Background

Ballina Shire Council (Council) has engaged GeoLINK to undertake two Road Safety Audits (RSA) for existing roads and road-related areas in the East Ballina/Shaws Bay area.

Section A is a continuous 1.5 km stretch of road extending from the eastern end of Missingham Bridge to the change in speed zone approximately 200 m beyond the Suvla Street intersection. This roadway is known (from west to east) as Hill Street, Pine Avenue and The Coast Road. Section A includes the intersection of Hill Street and Park Street/Brighton Street, which also falls within this audit.

This report is for Section B, comprising roadway, intersections, accesses, formal and informal car parking areas and pedestrian/cyclist facilities. The audit site is located east of and including the intersection of Hill Street and Park Street/Brighton Street.

This area is partly commercial and is a popular parking area for recreational activities, particularly in summer and school holidays. The parking arrangements are known to be often chaotic with uncontrolled parking on adjacent grassed areas.

This is a particularly challenging area regarding traffic control and safety. The area is not well defined by its geometry or edges and as a result vehicle paths and turning paths are difficult to predict. The uncontrolled nature of parking on adjacent grassed areas also contributes to this lack of definition.



Figure 1.1 Site Locality [Source: SIX Maps]

7.5 Traffic Issues, Hill Street/Brighton Street/Range Street/Shaws Bay Hotel and Caravan Park Entrances Area (Section B) - Road Safety Audit



Figure 1.2 The Site [Source: SIX Maps]

In the past there have been some proposals to more precisely define the geometry of this area in an attempt to bring about some order and conformity to traffic rules. None of these proposals have been adopted at this time.

1.2 Site Description

The site is a mix of road and road-related areas, comprising the Hill Street and Park Street intersection, Brighton Street and Range Street, as well as formal and informal parking areas. The area also provides vehicular and pedestrian/cyclist access to:

- A bus stop with shelter
- Two take-away food shops fronting Brighton Street;
- Four residential apartment blocks fronting Range Street, comprising 24 individual units in total;
- Shaws Bay Hotel and car parking area;
- Reflections Holiday Park (including caravan access);
- Existing amenities and sheltered picnic building;
- Shared path network extending north, east and south;
- Formal and informal parking areas to access the beach, parks and surrounding destinations.

The existing road pavement and surface within the audit area varies from satisfactory to poor.

7.5 Traffic Issues, Hill Street/Brighton Street/Range Street/Shaws Bay Hotel and Caravan Park Entrances Area (Section B) - Road Safety Audit

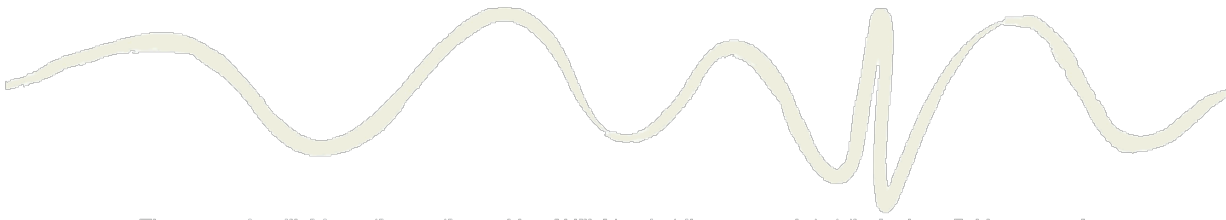

There are streetlights on the southern side of Hill Street at the approach to Missingham Bridge, one of which falls within the audit site. There is another streetlight on the northern side of Hill Street opposite the bus shelter, however its light-spill does not reach across the road.

The speed zone on Hill Street adjacent to the site is 60 km/h.

The Hill Street frontage of the site includes a shared path extending from Compton Drive to Missingham Bridge and beyond. This path links to another shared path at the south western corner of the site which extends east through the site and along the Richmond River 'North Wall'. There is another formalised path on the northern side of Hill Street, with a width of ~1.5 m. A pedestrian refuge provides connection between the two. There are no other formal paths within the site area, however much of the site appears to function as an unofficial shared zone.

The site is known to be popular with locals and visitors with an influx of beach-goers, holiday-makers and patrons to the Shaws Bay Hotel on weekends during the summer months and school holidays.

Photos of the site are provided in **Appendix A**.

1.3 Information Provided by the Client

The following background information has been provided by Council:

In the past there have been some proposals to more precisely define the geometry of this area in an attempt to bring about some order and conformity to traffic rules. None of these proposals have been adopted at this time. There is also some tension between the view this area should be controlled and the view that the area is best left in its present uncontrolled state as this provides more flexible parking opportunities.

An example of a draft design proposal to partially control this area is shown in **Appendix B**.

Crash data has been provided, capturing all reported crashes in the vicinity of the audit site for the five-year period between the 1st of July 2014 and the 30th of June 2019. However, the only recorded incident within this period directly relating to the audit site was a pedestrian struck by a vehicle while attempting to cross Hill Street 100 m south of the Pine Street intersection. The incident occurred after sunset in early April 2018 and resulted in an injury.

The Council also provided the audit team with a number of emails and letters from concerned residents. Copies with names and addresses removed are in **Appendix C**.

1.4 Audit Scope

This RSA will assess the existing road alignment and layout of Section B, considering the current geometry, edge restraints, linemarking, medians, signage, pathways and pedestrian/cyclist safety, property access and parking controls.

The scope of the RSA is limited to the existing infrastructure within the area defined as Section B (note this excludes the Shaws Bay Hotel access and car parking area).

There is some cross-over between the areas of Section A and Section B, mainly being the intersection of Hill Street and Park Street/Brighton Street and the Hill Street frontage of the Section B area. Deficiencies identified within the common area will be included in both audits.



7.5 Traffic Issues, Hill Street/Brighton Street/Range Street/Shaws Bay Hotel and Caravan Park Entrances Area (Section B) - Road Safety Audit



The audit will be carried out to consider the perspective of all road users.

The objective of the RSA is to identify any potential road safety issues or design deficiencies associated with the existing road that may need to be mitigated or rectified.

Although the RSA will not check the existing roadway against relevant standards and guidelines, some design-related compliance issues may be raised during the audit process.

Positive aspects of the road and infrastructure have not been recorded.

1.5 Audit Team

The audit has been carried out by suitably qualified team members registered as Road Safety Auditors by Transport for NSW.

1. Michelle Erwin

BE(Civil)(Hons), MTraf
Senior Civil Engineer, GeoLINK
Level 3 Lead Road Safety Auditor

2. Graeme Robertson

BE Tech(Civil)
Asset Management Coordinator, Richmond Valley Council
Level 2 Road Safety Auditor

3. Jarrod Connell

BE(Civil)
Civil Engineer, GeoLINK
Level 1 Road Safety Auditor



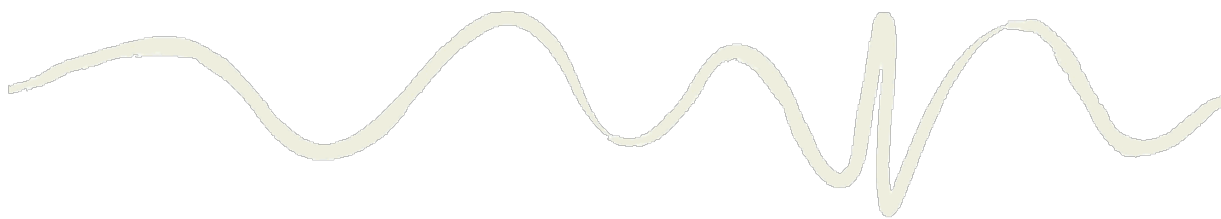

2. Audit Process

2.1 Methodology and Responsibilities

The RSA has been undertaken in accordance with:

- Austroads *Guide to Road Safety Part 6A: Implementing Road Safety Audits (2019)*; and
- NSW RMS *Guidelines for Road Safety Audit Practices (2011)*,

The RSA process includes the steps listed in the table below together with the party responsible for each task.

Table 2.1 Steps and responsibilities

Steps	Responsibility
Select the audit team	Client or Designer
Provide background information	Client or Designer
Hold a commencement meeting	Client and/or Designer and the Audit Team
Assess the documents / Inspect the site	Audit Team
Write the audit report and issue to client	Audit Team
Hold a completion meeting	Client and/or Designer and the Audit Team
Write the responses	Client and Designer
Implement the changes	Client or Designer

The client and designer in this case are both Ballina Shire Council.

2.2 Previous Audits

No previous RSAs have been carried out for this site. However, a separate RSA is currently being undertaken for Section A. Refer to **Section 1.1**.

2.3 Commencement Meeting

An initial meeting was held on site with Patrick Knight and Brett Howard from Council (the client) and Michelle Erwin from GeoLINK (lead auditor) on Thursday the 30th of April 2020. During the meeting, the scope of the audit was confirmed, as described in this report.

Mr Knight reiterated Council's desire for this audit to include recommendations for improvements to the area, with sketches of possible options to be provided within the RSA report. It was agreed that no more than five options, including the 'do nothing' option would be presented. Maintaining parking numbers while improving safety and amenity were highlighted by Council as priorities for this project.

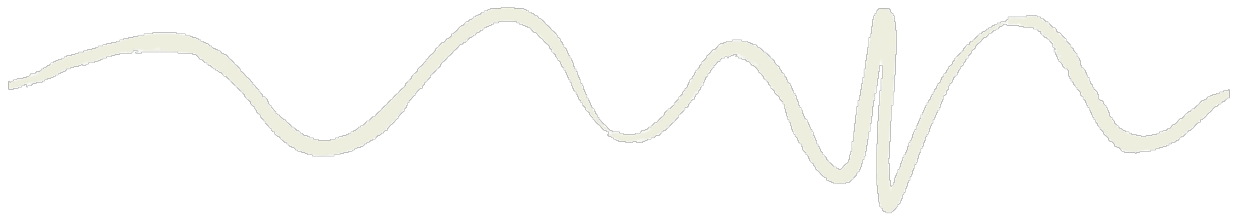

2.4 Site Inspections

The site investigation was undertaken by the audit team on the afternoon and evening of Thursday the 30th of April between 16:00pm and 18:30pm. The audit team drove through the sections of road including the Hill Street and Park Street/Brighton Street intersection, Brighton Street and Range Street, in daylight and night conditions. Further, the audit team walked within the area during daylight and dusk.

Temporary construction fencing was observed cordoning off a grassed area of the site on the south east side of the Hill/Brighton Street intersection. Mr Howard (Council) later confirmed that recent remediation works to repair damage in this area caused by excessive use as an overflow car parking area over the summer holiday period uncovered potential indigenous artefacts. Mr Howard advised that the area will likely be a constraint for future upgrade works.

The audit was carried out during the period of COVID19 pandemic restrictions, whereby picnics, sunbaking, gathering of non-household members greater than two people and any other non-essential, non-exercise related activities were banned. It was not a school holiday period. The weather was fine at the time of the site visit and there had been little to no rain in the 24 hours prior.

It should be understood that the vehicle and pedestrian traffic throughout the RSA area would be reduced from what is considered normal for this location due to the COVID19-related 'lockdown'. While this does not affect the road geometry, signage and linemarking etc., it does reflect on the use and should be considered as a factor in identifying the frequency of risk.

It is noted that the lead auditor is very familiar with the area, having resided in Range Street between 2006 and 2009 and since living and working in the area.

2.5 Completion Meeting

The objective of the completion meeting is to allow the auditor(s) to discuss the findings with the client for corrective action, where required. Although the meeting is not an occasion for the client to disagree with the audit findings, it is an opportunity for misunderstandings to be explained.

The completion meeting was held on the 27th of May 2020 by telephone between Michelle Erwin (Lead Auditor) and Patrick Knight (Council, the client), following submission of the audit report.

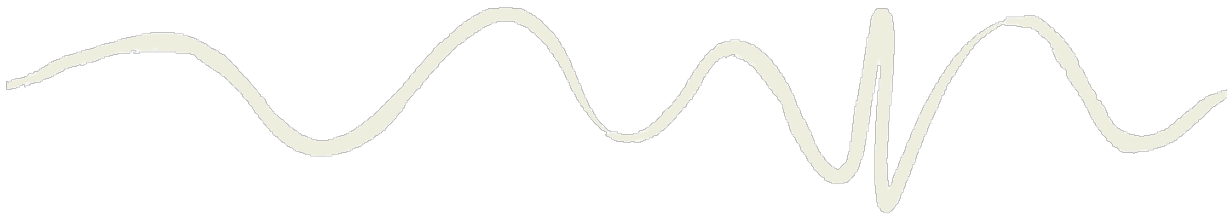

3. Risk Matrix

The audit findings include a risk ranking, determined using **Table 3.1** to **Table 3.4**, reproduced from The Austroads *Guide to Road Safety Part 6A*.

Table 3.1 How often is the problem likely to lead to a crash?

<i>Frequency</i>	<i>Description</i>
Frequent	Once or more per week
Probable	Once or more per year (but less than once per week)
Occasional	Once every five to ten years
Improbable	Less often than once every ten years

Table 3.2 What is the likely severity of the resulting crash type?

<i>Severity</i>	<i>Description</i>	<i>Examples</i>
Catastrophic	Likely multiple deaths	<ul style="list-style-type: none"> ▪ High-speed, multi-vehicle crash on a freeway. ▪ Car runs into crowded bus stop. ▪ Bus and petrol tanker collide. ▪ Collapse of a bridge or tunnel.
Serious	Likely death or serious injury	<ul style="list-style-type: none"> ▪ High or medium-speed vehicle/vehicle collision. ▪ High or medium-speed collision with a fixed roadside object. ▪ Pedestrian or cyclist struck by a car.
Minor	Likely minor injury	<ul style="list-style-type: none"> ▪ Some low-speed vehicle collisions. ▪ Cyclist falls from bicycle at low speed. ▪ Left-turn rear-end crash in a slip lane.
Limited	Likely trivial injury or property damage only	<ul style="list-style-type: none"> ▪ Some low-speed vehicle collisions. ▪ Pedestrian walks into object (no head injury). ▪ Car reverses into post.

Table 3.3 Resulting level of risk

	<i>Frequent</i>	<i>Probable</i>	<i>Occasional</i>	<i>Improbable</i>
<i>Catastrophic</i>	Intolerable	Intolerable	Intolerable	High
<i>Serious</i>	Intolerable	Intolerable	High	Medium
<i>Minor</i>	Intolerable	High	Medium	Low
<i>Limited</i>	High	Medium	Low	Low

Table 3.4 Treatment approach

<i>Frequency</i>	<i>Description</i>
Intolerable	Must be corrected
High	Should be corrected or the risk significantly reduced, even if the treatment cost is high
Medium	Should be corrected or the risk significantly reduced, if the treatment cost is moderate but not high
Low	Should be corrected or the risk reduced, if the treatment cost is low

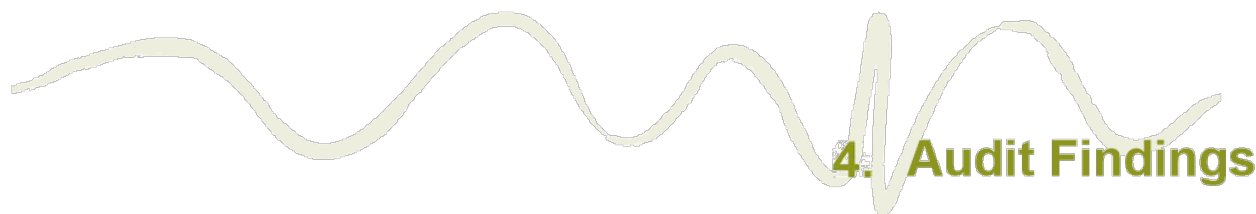

4. Audit Findings

The following table details the findings of the RSA. The client responses were provided by Patrick Knight of Ballina Shire Council and added in the second issue of this report.

Table 4.1 Audit findings

Audit findings	Risk Ranking	Client	
		Accept Yes/No	Comments
1.0 GEOMETRY			
<p>1.1 Vehicles queuing to turn right into Brighton Street Several vehicles were observed queuing to turn right into Brighton Street from Hill Street. Eastbound through traffic was required to use the auxiliary lane to pass these vehicles. The auxiliary lane appeared somewhat short given the number of vehicles observed in the through lane waiting for a gap in the oncoming traffic to allow a right turn, and it is expected the volumes of traffic for all manoeuvres in the area would be much greater during peak summer periods.</p> <p>Vehicles travelling at 60 km/h off Missingham Bridge, rounding the left-hand bend may not perceive the stopped vehicles ahead in the through lane and may rear-end vehicles queued to turn right.</p> <p>It is recommended that consideration be given to reconfiguration of this intersection in conjunction with the area to the east of the Hill Street/Brighton Street intersection, including formalising the Brighton Street intersection, the parking areas north and south of Brighton Street, and the pedestrian and cyclist facilities within the area.</p>	Occasional Limited Low	Yes	Options provided for reconfiguration will be considered.
<p>1.2 Shared bus zone and left turn lane The bus zone on Hill Street between Brighton Street and Compton Drive is also used as the left turn lane from Hill Street into Brighton Street. Vehicles wanting to turn left here while a bus is standing in the bus zone will either need to wait in the Hill Street through lane (potentially resulting in a rear-end collision) or turn in front of the bus (potentially resulting in the bus colliding with the passenger side of the turning vehicle).</p> <p><i>Refer 1.1 for recommendations that will mitigate this risk.</i></p>	Occasional Minor Medium	Yes	As above.

7.5 **Traffic Issues, Hill Street/Brighton Street/Range Street/Shaws Bay Hotel and Caravan Park Entrances Area (Section B) - Road Safety Audit**

Audit findings	Risk Ranking	Client	
		Accept Yes/No	Comments
<p>1.3 Bus obscuring view for motorists exiting Brighton Street Street A bus stopped in the bus zone on Hill Street between Brighton Street and Compton Drive would obscure the view of westbound traffic on Hill Street for motorists wishing to exit Brighton Street.</p> <p>This may result in a broadside crash between the vehicle leaving Park Street and through-traffic travelling west past the stopped bus.</p> <p><i>Refer 1.1 for recommendations that will mitigate this risk.</i></p>	<p>Improbable Serious</p> <p>Medium</p>	Yes	As above.
<p>1.4 Range Street no through road There are no provisions within Range Street (~75m in length with 9m carriageway width) to allow vehicles to turn around without encroaching on private property (i.e. using one of the driveways to make a three-point turn). It is assumed that garbage collection trucks either reverse in or out of Range Street to collect refuse from the residents' garbage bins.</p> <p>Larger vehicles (garbage/delivery/removalist trucks) unable to make the three-point turn within the space available will be forced to reverse out of the street and there is risk of collision with other vehicles entering Range Street</p>	<p>Improbable Minor</p> <p>Low</p>	Yes	As above.
<p>1.5 Intersection of Brighton Street (east-west) and Brighton Street (north-south) In plan view, the geometry of this 'intersection' suggests that the two sections of Brighton Street join with a tee-intersection. However, the linemarking, lack of give-way (or similar) signage and ill-defined edges create a space of confusion, with motorists clearly unsure which movements have right-of-way. This area was observed to operate on an ad-hoc basic, with motorists using eye-contact and hand signals to determine who would proceed with competing movements. During peak times, this area is well known to be chaotic and disorganised.</p> <p>Confusion within a roadway, even at low speeds creates a risk of collisions between motorists who perceive the environment in different ways.</p> <p>It is recommended that this intersection be formalised, including appropriate signage, linemarking and edge restraints (<i>refer audit finding 1.1</i>).</p>	<p>Probable Minor</p> <p>High</p>	Yes	As above.



7.5 **Traffic Issues, Hill Street/Brighton Street/Range Street/Shaws Bay Hotel and Caravan Park Entrances Area (Section B) - Road Safety Audit**

Audit findings	Risk Ranking	Client	
		Accept Yes/No	Comments
2.0 PARKING			
<p>2.1 Informal / formal parking areas south of the Brighton Street intersection The formal and informal parking area south of the Brighton Street intersection adjacent to the amenities block, shoreline and the Reflections Holiday Park includes areas of unusual angles and dimensions, allowing for the use of some areas (e.g. parking, access or manoeuvring) to be unclear.</p> <p>During peak periods when parking is in high demand, there is a risk that motorists will park in such a way to cause collisions with other motorists attempting to park/unpark or circulate within the area.</p> <p>It is recommended that the parking areas be formalised with the aim to maximise parking and safety for motorists and pedestrians (<i>refer audit finding 1.1</i>).</p>	Occasional Minor Medium	Yes	Options provided for reconfiguration will be considered.
<p>2.2 Informal / formal parking areas north of the Brighton Street intersection The formal and informal parking area north of the Brighton Street intersection adjacent to the takeaway shops and Range Street includes areas of unusual angles and dimensions, allowing for the use of some areas (e.g. parking, access or manoeuvring) to be unclear.</p> <p>During peak periods when parking is in high demand, there is a risk that motorists will park in such a way to cause collisions with other motorists attempting to park/unpark or circulate within the area.</p> <p>It is recommended that the parking areas be formalised with the aim to maximise parking and safety for motorists and pedestrians (<i>refer audit finding 1.1</i>).</p>	Occasional Minor Medium	Yes	As above.
<p>2.3 Parking in Range Street It is noted that residents have complained about service vehicles related to the takeaway food shops park at the end of Range Street while loading/unloading, temporarily blocking passage for other vehicles. This could be a hazard if emergency services were unable to enter/exit Range Street as needed.</p> <p>Reconfiguration of the area is recommended to alleviate this issue.</p>	Comment only	Yes	As above.



7.5 **Traffic Issues, Hill Street/Brighton Street/Range Street/Shaws Bay Hotel and Caravan Park Entrances Area (Section B) - Road Safety Audit**

Audit findings	Risk Ranking	Client	
		Accept Yes/No	Comments
3.0 SIGNAGE AND LINEMARKING			
<p>3.1 Lack of signage and linemarking The area east of the Hill Street / Brighton Street intersection is lacking in signage and linemarking directing traffic with regard to vehicle paths, movement priorities and parking.</p> <p>Confusion within a roadway, even at low speeds creates a risk of collisions between motorists who perceive the environment in different ways.</p> <p><i>Refer 1.1 for recommendations that will mitigate this risk.</i></p>	<p><i>Probable</i> <i>Minor</i></p> <p>High</p>	<p>Yes</p>	<p>Options provided for reconfiguration will be considered.</p>
<p>3.2 Shared path sign at Brighton Street The Shared Path / End sign on the south eastern corner of the Hill Street / Brighton Street intersection appears to have been hit by a vehicle and is leaning into the shared path.</p> <p>It is recommended this sign be repaired as required.</p>	<p>Comment only</p>	<p>Noted</p>	<p>-</p>
4.0 PEDESTRIANS AND CYCLISTS			
<p>4.1 Minimal streetlighting near Hill Street / Park Street / Brighton Street intersection Minimal street lighting was observed on Hill Street between the Park Street / Brighton Street intersection and the Compton Drive intersection. Given that this area is very popular with pedestrians and includes take away shops and a pub open beyond daylight areas, there is a risk that motorists may strike a pedestrian crossing the street after dark.</p> <p>It is recommended that consideration be given to engaging a streetlighting expert to assess the area for compliance with best practices.</p>	<p><i>Occasional</i> <i>Serious</i></p> <p>High</p>	<p>Yes</p>	<p>Will be considered as part of design for reconfiguration.</p>



7.5 **Traffic Issues, Hill Street/Brighton Street/Range Street/Shaws Bay Hotel and Caravan Park Entrances Area (Section B) - Road Safety Audit**

Audit findings	Risk Ranking	Client	
		Accept Yes/No	Comments
<p>4.2 Unclear pedestrian and cyclist paths</p> <p>Much of the area within Section B is bounded by shared pathways, including a shared path along the Hill Street frontage connecting the area to the Ballina CBD via Missingham Bridge, to Shaws Bay and Lighthouse Beach to the north then east along Compton Drive, and along North Wall south of the audit area. However, there are no formal pedestrian and/or cyclist paths within the central portion of the site providing clear and safe access between the amenities block/beach/holiday park and the Shaws Bay Hotel or the takeaway food shops. Further, several pedestrians were observed to cut across the steep downward grass embankment from the shared path at the corner of Hill Street and Compton Drive to Brighton Street rather than continue along the shared path past the bus stop. The pedestrians 'cutting the corner' were observed to take this route to get to the takeaway shops as well as to access the shared path at the south of the site, heading south east along North Wall.</p> <p>The steep embankment is close to the edge of the concrete path. This section of path is particularly hazardous to cyclists travelling down Hill Street at speed and risk losing control over the embankment.</p> <p>The steep embankment poses a trip hazard to pedestrians. Is it recommended that consideration be given to formalising this route (e.g. with steps and a hand railing), or blocking it off by extending the existing barrier fence further along the shared path. The recommendation to reconfigure the area may also alleviate the hazard.</p>	<p>Occasional Minor Medium</p>	<p>Yes</p>	<p>Options provided for reconfiguration will be considered.</p>
<p>4.3 Guard rail protection</p> <p>There is a timber board affixed to the rear of the existing guard rail on the south west corner of the Hill Street / Compton Drive intersection, adjacent to the shared path. This is presumably to prevent cyclists from incurring an injury if they were to collide with the unprotected rear of the guardrail. However, the board appears to be insufficient to achieve this goal and is presumed to be non-compliant with current Australian Standards for shared paths and cycleways.</p> <p>It is recommended that the intention of this fixture be considered to ensure it does not pose an additional safety risk, specifically for cyclists.</p>	<p>Comment only</p>	<p>Noted</p>	<p>Will be investigated.</p>



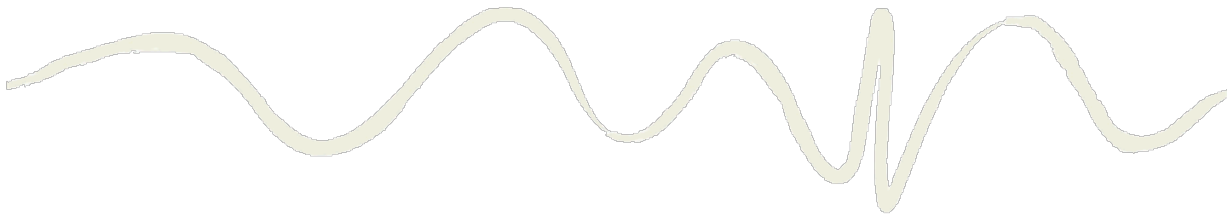

5. Recommendations

The following recommendations are proposed for consideration by the client in relation to improving the safety for road users within the audit area.

Table 5.1 Recommendations for client consideration to improve road safety

Audit finding	Recommendations
1.1, 1.2, 1.3, 1.5 2.1, 2.2, 2.3, 3.1	Consider reconfiguration of the Hill Street / Park Street / Brighton Street intersection in conjunction with the area to the east of Brighton Street, including formalising the Brighton Street intersection, the parking areas north and south of Brighton Street, and the pedestrian and cyclist facilities within the area.
3.2	Repair Shared Path sign on the south eastern corner of the Hill Street / Brighton Street intersection.
4.1	Engage a streetlighting expert to assess the area for compliance with best practices.
4.2	Formalise a direct pedestrian route down the grassed embankment (e.g. steps) from the Hill Street / Compton Drive intersection to the northern end of Brighton Street (opposite to the takeaway shops). Alternatively, extend the existing pedestrian barrier fencing along the southern side of the shared path around the Hill Street / Compton Drive intersection by approximately 40 m to prevent pedestrians from traversing up/down the steep embankment.
4.3	Consider the intention and appropriateness of the timber board fixed to the rear of the guard rail on the south west corner of the Hill Street / Compton Drive intersection, and inspect all shared path facilities for compliance with current standards.

Note that audit findings are colour coded according to the risk ranking determined in **Section 4**: Low, Medium, High

Three concept designs have been prepared to address many of the audit findings raised herein. Sketches of the three options are provided in **Appendix D**. Note that all sketches are subject to detailed design and feasibility studies to address construction costs and property acquisition.

All three options aim to improve the safety of the study area while maintaining or improving parking provisions and amenity. Consideration of a speed zone reduction from 60 km/h to 50 km/h as identified in the RSA prepared for Section A is also recommended to improve road safety and amenity.

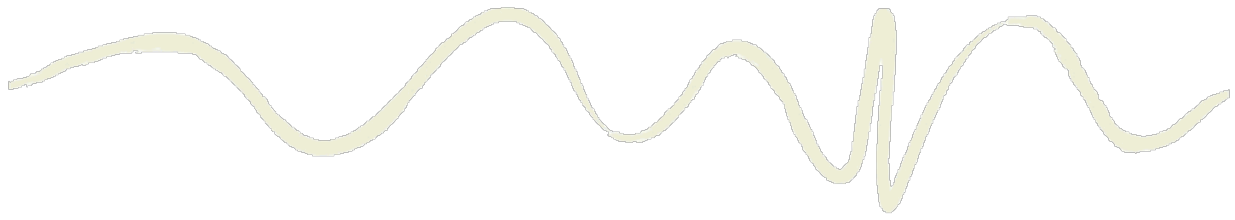

6. Concluding Statement

6.1 Identified Deficiencies

The audit process seeks to identify potential safety hazards. However, there is no guarantee that every deficiency has been identified. Further, even if all audit findings are addressed, this will not necessarily guarantee a safe site. Rather, addressing the findings of this report should improve the level of safety offered by the existing road network within the audit area.

As per **Section Error!** Reference source not found., several deficiencies have been identified. The risk associated with each issue has been assessed. As per **Table 3.4**, any issue with a risk ranking of 'medium' should be corrected if the cost of treatment is moderate. Issues with a risk rating of 'high' or 'intolerable' should be corrected or the risk significantly reduced even if the cost of treatment is high.

6.2 Responding to the Audit

As set out in the RSA guidelines, responsibility for the road design always rests with the client, and not with the auditor. A client is under no obligation to accept all the audit recommendations. Also, it is not the role of the auditor to agree to or approve of the client's response to the audit. Rather, the audit provides the opportunity to highlight potential problems and have them formally considered by the client, in conjunction with all other project considerations.

This formal RSA report should be responded to in writing, giving reasons for each rejection of an audit finding or recommendation. Acceptance of a recommendation may require no further comment, but explanation of how or when the action will be taken may be useful. The audit response does not need to be provided to the audit team but should be kept on file as a record of due diligence.

6.3 Concluding Statement

Each member of the audit team has examined the plans listed in **Error!** Reference source not found.. The audit has been carried out for the sole purpose of identifying any features of the existing road network within the audit scope which could be altered or removed to improve the safety of the proposal. The identified issues have been noted in this report and given a risk rating. The accompanying findings are provided to for the consideration by the client for implementation.

22nd May 2020

Michelle Erwin (Audit Team Leader)

22nd May 2020

Graeme Robertson (Audit Team Member)

22nd May 2020

Jarrod Connell (Audit Team Member)

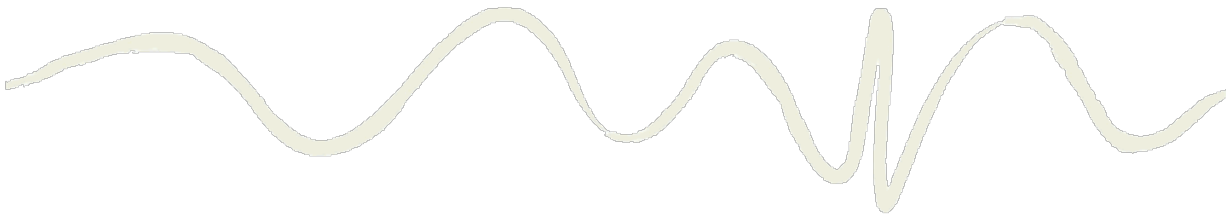

Copyright and Usage

©GeoLINK, 2020

This document, including associated illustrations and drawings, was prepared for the exclusive use of Ballina Shire Council. It is not to be used for any other purpose or by any other person, corporation or organisation without the prior consent of GeoLINK. GeoLINK accepts no responsibility for any loss or damage suffered howsoever arising to any person or corporation who may use or rely on this document for a purpose other than that described above.

This document, including associated illustrations and drawings, may not be reproduced, stored, or transmitted in any form without the prior consent of GeoLINK. This includes extracts of texts or parts of illustrations and drawings.



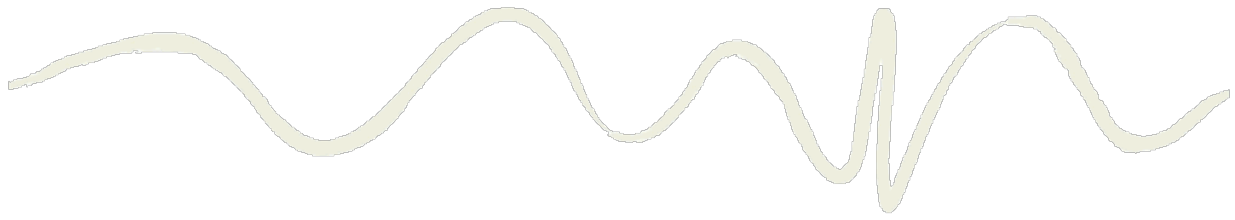

Appendix A
Site Photos



Road Safety Audit – Section B: Intersection, Access and Parking at Hill/Park St.
3586-1011

7.5 Traffic Issues, Hill Street/Brighton Street/Range Street/Shaws Bay Hotel and Caravan Park Entrances Area (Section B) - Road Safety Audit



The following photos of the audit area are taken from video footage recorded on 26/04/2020 by the lead auditor.

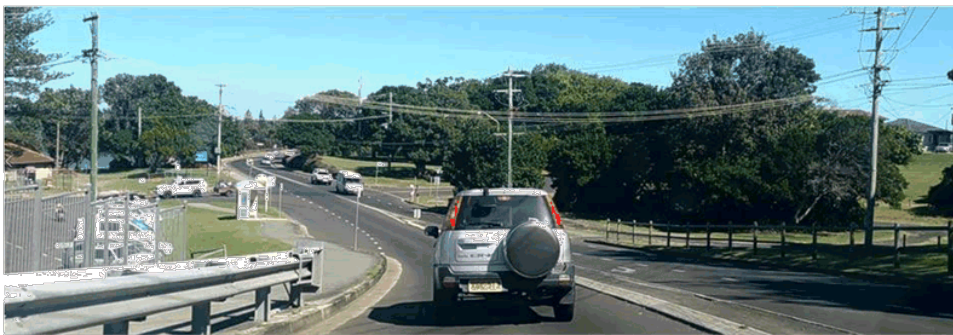
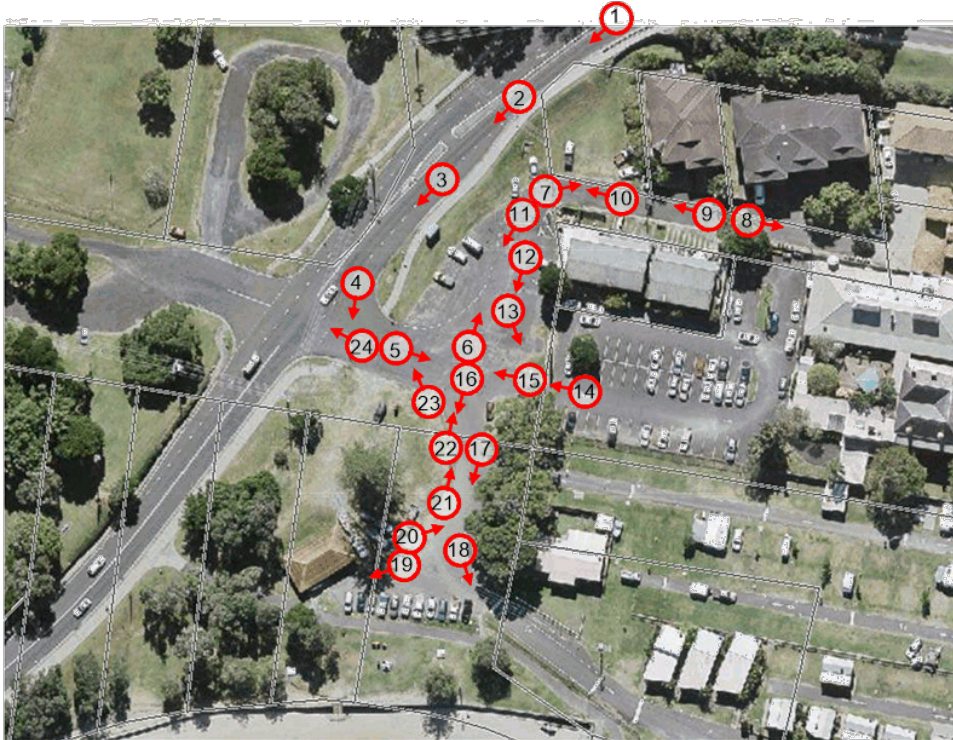

Photo 1 – Hill Street looking towards Brighton Street / Park Street intersection



Road Safety Audit – Section B: Intersection, Access and Parking at Hill/Park St.
3586-1011

7.5 **Traffic Issues, Hill Street/Brighton Street/Range Street/Shaws Bay Hotel and Caravan Park Entrances Area (Section B) - Road Safety Audit**

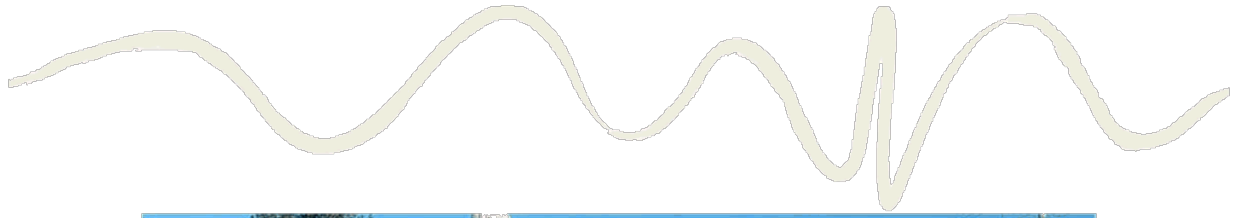

Photo 2 – Hill Street, bus zone and refuge



Photo 3 – Hill Street, bus stop and Brighton Street / Park Street intersection



Photo 4 – Brighton Street, fenced area



Road Safety Audit – Section B: Intersection, Access and Parking at Hill/Park St.
3586-1011

7.5 **Traffic Issues, Hill Street/Brighton Street/Range Street/Shaws Bay Hotel and Caravan Park Entrances Area (Section B) - Road Safety Audit**

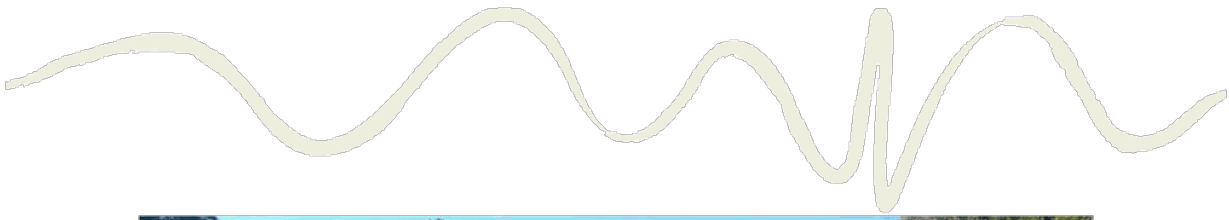

Photo 5 – Brighton Street, entry to Shaws Bay Hotel car park



Photo 6 – Brighton Street, parking and take-away food shops



Photo 7 – Range Street, informal parking



Road Safety Audit – Section B: Intersection, Access and Parking at Hill/Park St.
3586-1011

7.5 **Traffic Issues, Hill Street/Brighton Street/Range Street/Shaws Bay Hotel and Caravan Park Entrances Area (Section B) - Road Safety Audit**

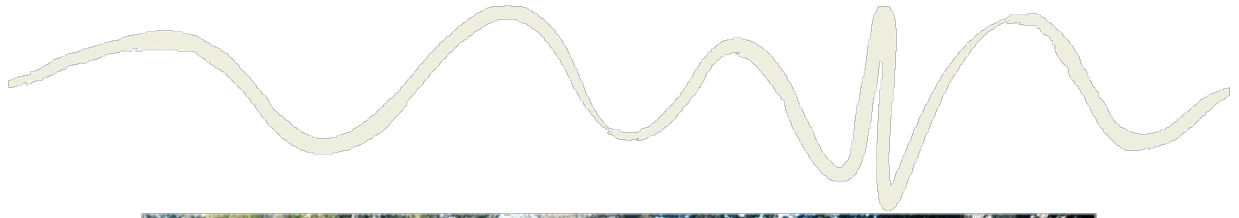

Photo 8 – Range Street



Photo 9 – Range Street



Photo 10 – Range Street



Road Safety Audit – Section B: Intersection, Access and Parking at Hill/Park St.
3586-1011

7.5 Traffic Issues, Hill Street/Brighton Street/Range Street/Shaws Bay Hotel and Caravan Park Entrances Area (Section B) - Road Safety Audit

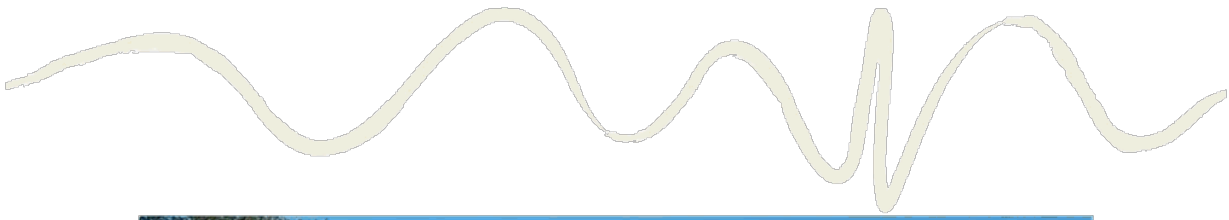

Photo 11 – Brighton Street, semi-formal parking



Photo 12 – 'Intersection' of Brighton Street (east-west) and Brighton Street (north-south)



Photo 13 – Brighton Street, informal parking



7.5 **Traffic Issues, Hill Street/Brighton Street/Range Street/Shaws Bay Hotel and Caravan Park Entrances Area (Section B) - Road Safety Audit**



Photo 14 – Shaws Bay Hotel car park, view of Brighton Street intersection



Photo 15 – Interface of Shaws Bay Hotel car park and Brighton Street



Photo 16 – Intersection of Brighton Street, fenced area



7.5 Traffic Issues, Hill Street/Brighton Street/Range Street/Shaws Bay Hotel and Caravan Park Entrances Area (Section B) - Road Safety Audit

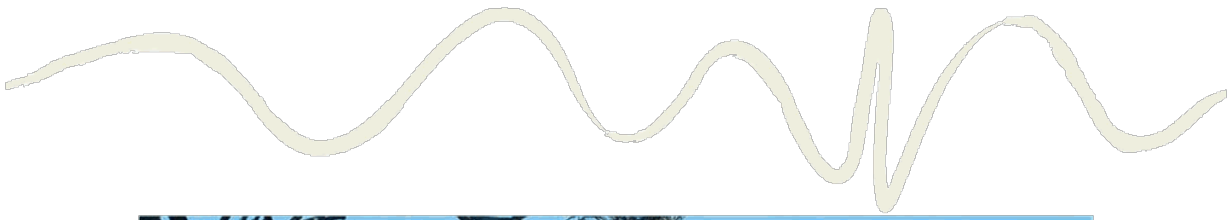

Photo 17 – Brighton Street, view of parking area



Photo 18 – Brighton Street, entry to Reflections Holiday Park



Photo 19 – Parking and amenities building



Road Safety Audit – Section B: Intersection, Access and Parking at Hill/Park St.
3586-1011

7.5 Traffic Issues, Hill Street/Brighton Street/Range Street/Shaws Bay Hotel and Caravan Park Entrances Area (Section B) - Road Safety Audit

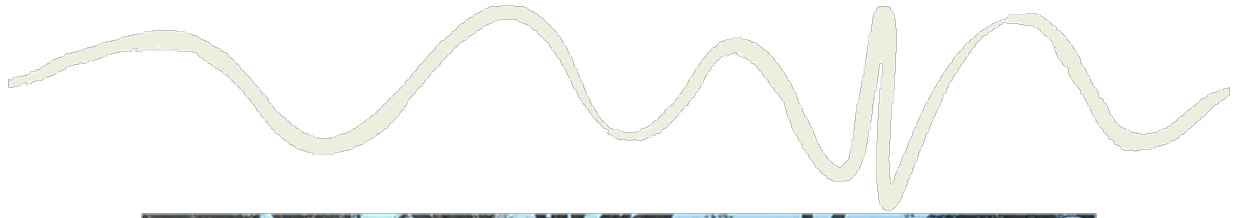

Photo 20 – Informal parking fronting Reflections Holiday Park



Photo 21 – Brighton Street



Photo 22 – Intersection of Brighton Street (east-west) and Brighton Street (north-south)



Road Safety Audit – Section B: Intersection, Access and Parking at Hill/Park St.
3586-1011

7.5 Traffic Issues, Hill Street/Brighton Street/Range Street/Shaws Bay Hotel and Caravan Park Entrances Area (Section B) - Road Safety Audit



Photo 23 – Intersection of Brighton Street (east-west) and Brighton Street (north-south)

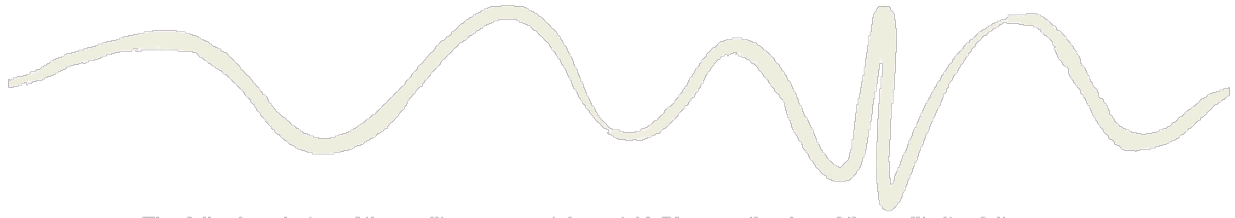

Photo 24 – Intersection of Brighton Street and Hill Street



Road Safety Audit – Section B: Intersection, Access and Parking at Hill/Park St.
3586-1011

7.5 Traffic Issues, Hill Street/Brighton Street/Range Street/Shaws Bay Hotel and Caravan Park Entrances Area (Section B) - Road Safety Audit



The following photos of the audit area were taken at 16:50pm on the day of the audit site visit, 30/04/2020.

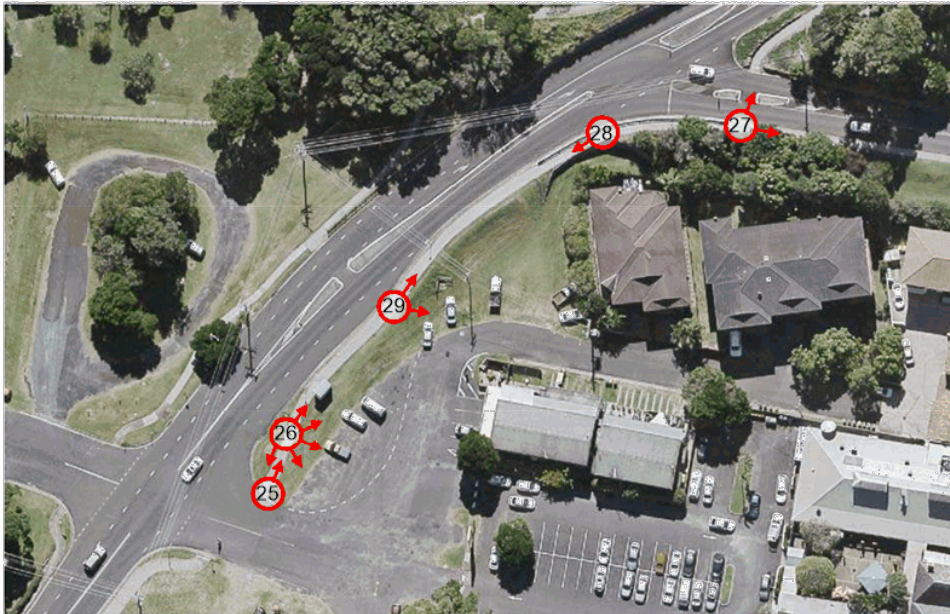

Photo 25 – Hill Street, bus stop and refuge



Road Safety Audit – Section B: Intersection, Access and Parking at Hill/Park St.
3586-1011

7.5 Traffic Issues, Hill Street/Brighton Street/Range Street/Shaws Bay Hotel and Caravan Park Entrances Area (Section B) - Road Safety Audit

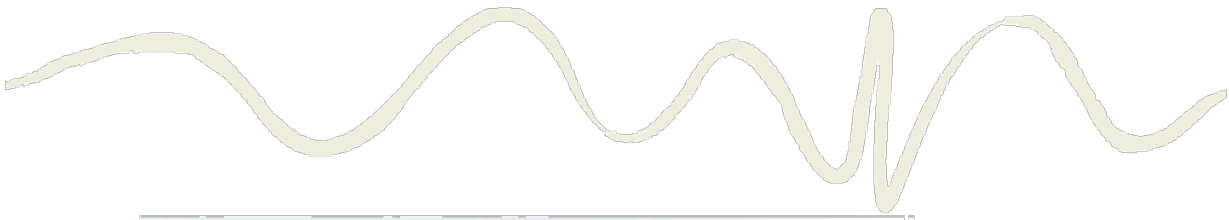

Photo 26(a) – Hill Street, bus stop, Brighton Street informal parking



Photo 26(b) – Brighton Street, information parking and take away food shops



Road Safety Audit – Section B: Intersection, Access and Parking at Hill/Park St.
3586-1011

7.5 **Traffic Issues, Hill Street/Brighton Street/Range Street/Shaws Bay Hotel and Caravan Park Entrances Area (Section B) - Road Safety Audit**

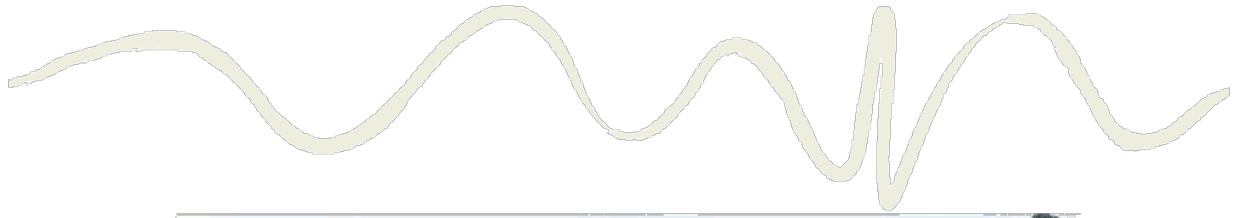

Photo 26(c) – Brighton Street



Photo 26(d) – Brighton Street



7.5 Traffic Issues, Hill Street/Brighton Street/Range Street/Shaws Bay Hotel and Caravan Park Entrances Area (Section B) - Road Safety Audit



Photo 26(e) – Brighton Street



Photo 27(a) – Compton Drive at Hill Street intersection, refuge island



Road Safety Audit – Section B: Intersection, Access and Parking at Hill/Park St.
3586-1011

7.5 Traffic Issues, Hill Street/Brighton Street/Range Street/Shaws Bay Hotel and Caravan Park Entrances Area (Section B) - Road Safety Audit

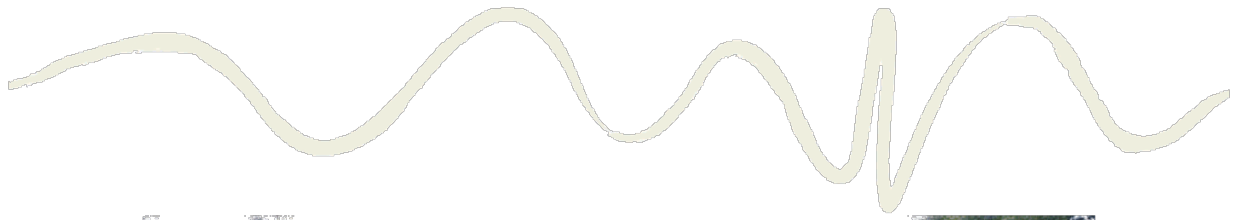

Photo 27(b) – Compton Drive at Hill Street intersection, footpath



Photo 27(c) – Compton Drive, footpath



Road Safety Audit – Section B: Intersection, Access and Parking at Hill/Park St.
3586-1011

7.5 Traffic Issues, Hill Street/Brighton Street/Range Street/Shaws Bay Hotel and Caravan Park Entrances Area (Section B) - Road Safety Audit

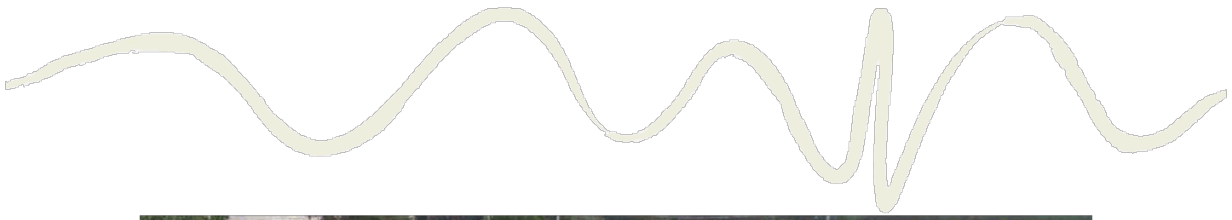

Photo 28 – Hill Street, shared path, barrier fencing, guard rail with timber board



Photo 29(a) – Range Street



Road Safety Audit – Section B: Intersection, Access and Parking at Hill/Park St.
3586-1011

7.5 Traffic Issues, Hill Street/Brighton Street/Range Street/Shaws Bay Hotel and Caravan Park Entrances Area (Section B) - Road Safety Audit

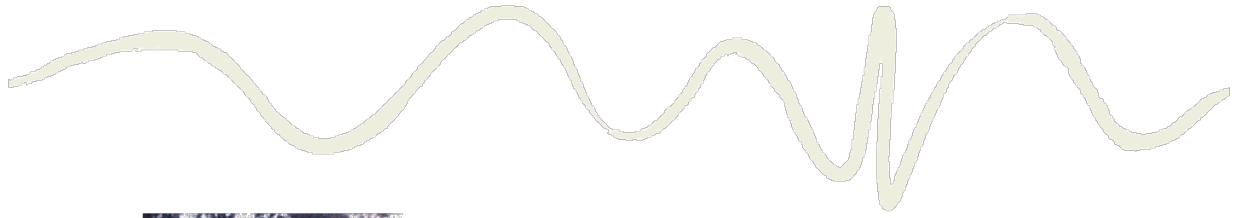
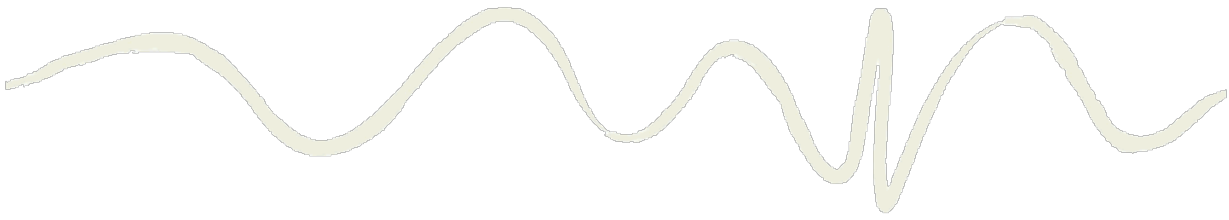

Photo 29(b) – Hill Street, shared path



Road Safety Audit – Section B: Intersection, Access and Parking at Hill/Park St.
3586-1011



Appendix B

Draft Design Provided by Council



Road Safety Audit – Section B: Intersection, Access and Parking at Hill/Park St.
3586-1011

7.5 Traffic Issues, Hill Street/Brighton Street/Range Street/Shaws Bay Hotel and Caravan Park Entrances Area (Section B) - Road Safety Audit



Road Safety Audit – Section B: Intersection, Access and Parking at Hill/Park St.
3586-1011

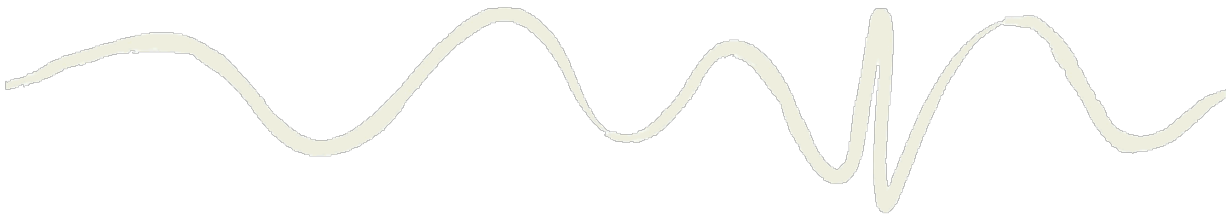

Appendix C

Correspondence from Local Residents



Road Safety Audit – Section B: Intersection, Access and Parking at Hill/Park St.
3586-1011

7.5 Traffic Issues, Hill Street/Brighton Street/Range Street/Shaws Bay Hotel and Caravan Park Entrances Area (Section B) - Road Safety Audit

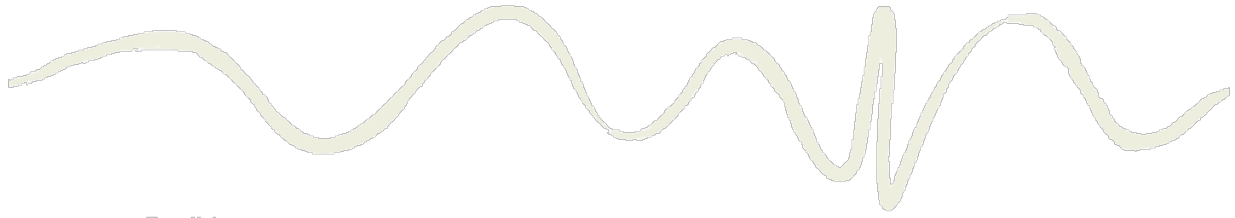

Email 1

"With the closure of the parking in front of the Shaws bay hotel area recently by your counterparts , who by the way, have no idea what a debacle this is going to cause this long Australia Day weekend, we would like to bring to your attention the problems occurring across this whole area.

We believe that this is due to the increased traffic through this area over the last twelve months, caused in part due to the beaches popularity as well as the new cafe and coffee shop.

We live down range street and have had many near accidents due to the lack of clarity in regard to parking and the absence of any clear line markings across the whole area causing most visitors to not even realise that it is a road that carries quite a lot of traffic all year.

We believe that something must be done as soon as possible to improve the whole area to make it safer for all. At the very least , clear lane markings and traffic separators must be considered asap .

Also the corner in front of the coffee shop often gets blocked by vehicles parking on the bend , delivery trucks parked right on the corner for up to 30 mins making it extremely difficult to get in and out of range street, let alone seeing customers of both shops meandering all over the road.

It is a recipe for a disaster to happen at some time. I personally am amazed that nothing has happened to cause injury that I am aware of. The road surface is breaking up and has been patched up many times. In reality , the whole area has become an eyesore and a mess.

Please consider working with your counterparts responsible for the park area and fix the whole area at the one time."

Email 2.

"Hi, I am concerned about the parking / number of cars, especially in holiday periods, around the Shaws Bay Kiosk beach area. Has the Council considered at least making some of the parking 4 hourly to stop cars (who are most likely overflowing from the caravan park) being permanently parked so that day visitors have even less access to parking? I'm also concerned about the erosion that's occurring from 4WDs parking on the grass / sand in the area.

Another area that might need to be blocked off to cars is along the river (behind the Tourist information Centre). There's ample parking there but, since there's access, people drive there cars right up to the riverbank. This is also causing damage to the riverfront since it is so dry. There's no need for the cars to be parked on the riverbank when its such a short walk from the car park."

Email 3.

"I would like to draw your attention to the safety issues arising from the lack of separation between vehicle and pedestrian traffic on Pine Avenue and Hill Street East Ballina. The section I am referring to is between the Suvla Street and Crompton Drive intersections.

Extensive road works were completed some years ago that resulted in the formed footpath being constructed hard against the southbound traffic lane. With the development north of Ballina this road is extremely busy especially during the morning and afternoon 'peak' periods and weekends. The speed limit on this road is still 60km an hour which seems excessive when cars, trucks and buses are passing pedestrians only separated by the width of the gutter.

I appreciate that this is not a straight forward problem to fix. Because there is no parking lane or allocation on this section of road a large percentage of the gutter length is layback to allow vehicle access to the residential properties. This precludes the use of a physical barrier such as guard rails to separate vehicles and pedestrians as we have on Missingham bridge and adjacent to the Crompton Drive intersection.



Road Safety Audit – Section B: Intersection, Access and Parking at Hill/Park St.
3586-1011

7.5 Traffic Issues, Hill Street/Brighton Street/Range Street/Shaws Bay Hotel and Caravan Park Entrances Area (Section B) - Road Safety Audit

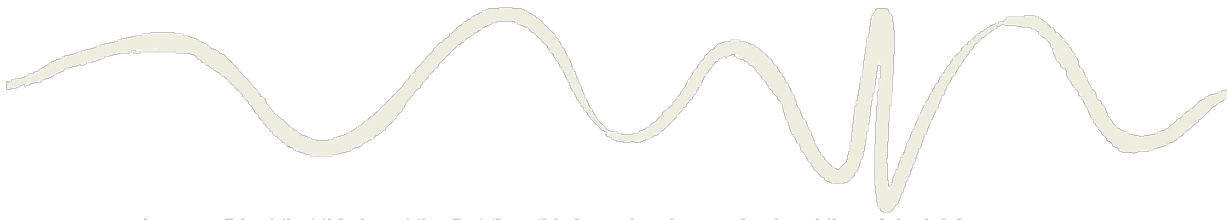

I am confident that this is not the first time this issue has been raised and the original risk assessments associated with the road construction would have identified this design as having significant safety implications for pedestrians. I would ask you to urgently consider a reduction in the speed limit while other measures such as traffic calming and speed limit enforcement are evaluated."

Email 4

"Over the past few months the parking around Shaw's Bay in Brighton Street has increased to a point that it is now dangerous and also becoming very inconvenient to all of the residents in Range Street.

On weekends, public and school holidays and Monday mornings, overflow traffic and parking from the hotel, shops, and the beach is at times blocking the street. Shop truck deliveries have blocked the street for up to 10 to 15 minutes, with the drivers refusing to move " because they will only be a few minutes". If there was any emergency this is not acceptable, as residents cannot get in or out.

Parking in Range Street on Sundays is stopping residents from placing garbage bins, street-side for Monday morning pickup. Last week I had been told the garbage truck had to return at a later time because Sunday " left over parking" was still blocking the street that Monday morning. Could we have NO STANDING signs installed on the southern side of Range Street?

The access to Brighton Street off Compton Drive has become dangerous as well. I have brought this to the Council attention before.

Cars, 4WD's and trucks, and Byron Bay surf schools are coming down Compton Drive and NOT turning into Brighton Street but driving straight across the intersection, into what WAS the park.

Unfortunately this is now an eroded dust bowl, from all the vehicle traffic and parking. I have nearly been hit by a car doing this and some of our neighbors have told me of similar incidents. At Christmas this year I witnessed a young child run out from behind the phone booth, nearly hit by a large 4WD, which came directly off Compton Drive. This park needs to be fenced off and dividing median strip built at the intersection to force drivers to turn in safely, before someone is injured or worse."

Email 5

"I have been concerned for some time about the complete disregard by drivers exiting Crompton Drive onto Hill St @ Shaw's Bay.

I am very concerned for the safety of drivers coming down Hill St and am worried about a serious accident occurring at the location where the two streets intersect. There is a stop sign on the corner of Crompton which on many occasions is completely ignored. I live @ East Ballina and to drive to town I only have 2 options Missingham bridge or via E/B and Angles Beach Drive.

When Southern Cross high school was in operation I drove a school bus (which most days was fully loaded) from SCHS to the interchange @ the old Ballina High school via Links Ave and Hill St Missingham etc. on most occasions I would have to brake heavily to avoid a collision with vehicles shooting out of Crompton drive without observing the stop sign.

Yesterday I decided that I had had enough as I was driving down Hill St in my own car a vehicle shot out of Crompton with no reduction of speed I had to brake heavily to avoid a collision. So I noted the registration of the vehicle and drove straight to the police station to report the incident. The officer at reception told me that there was nothing they could do as they did not witness the event, and that I should report it to the council, which is what I am now doing.

Something needs to be done before somebody is injured or even killed."



Road Safety Audit – Section B: Intersection, Access and Parking at Hill/Park St.
3586-1011

7.5 Traffic Issues, Hill Street/Brighton Street/Range Street/Shaws Bay Hotel and Caravan Park Entrances Area (Section B) - Road Safety Audit

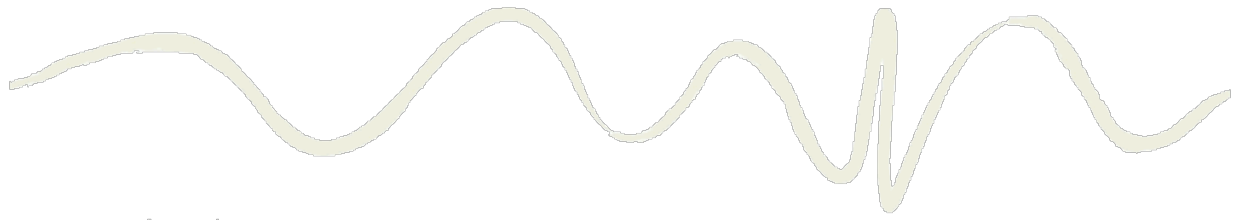

Letter 1

I BELIEVE THERE IS A SERIOUS PROBLEM AT THE ENTRANCE TO THE SHAW'S BAY (BRIGHTON ST) OFF HILL STREET.

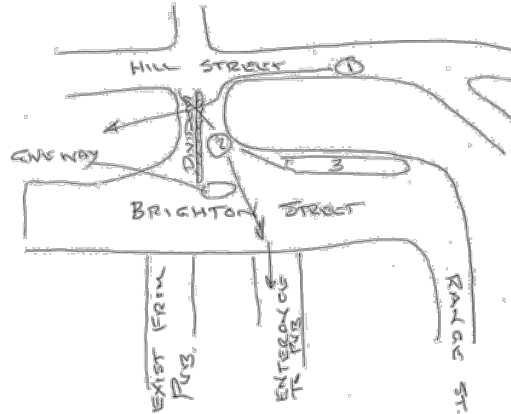

1) CARS COMING DOWN HILL STREET CUT ACCESS TO ENTRANCE TO SHAW'S BAY ONTO THE GRASS AREA, NOT GIVING WAY

2) CARS TURNING INTO THE HOTEL (AT PRIVATE DRIVEWAY) DO NOT GIVE WAY TO TRAFFIC ON BRIGHTON STREET

3) CAR PARKED AT (3) CUT ACCESS TO ENTRANCE TO PUB

I FEEL THERE NEED A DIVIDER AT (4) WITH A GIVING WAY SIGN.



Letter 2

Dear Sir,

I am writing to express concern about a couple of parking matters.

Firstly, for some years there has been a problem over the Christmas school holidays with parking in the area between the Caravan Park at Shaws Bay and the approach to the Missingham Bridge. This problem is apparently caused by the Caravan Park limiting the number of vehicles patrons can park inside the Caravan Park, causing them to park semi-permanently as close as possible outside the park. The little beach (where the fishermen net sea mullet) is an extremely popular spot for people with very young children and also for older bathers who wish to avoid being buffeted by the surf. Our daughter and 8 month old grandson were with us for Christmas and January and found it extremely difficult to get a parking spot even in the area across the road towards the Serpentine. People with babies need to carry prams or strollers and nappy bags etc and this is difficult over long distances. This problem would seem to be able to be remedied by the introduction of timed parking spots along the foreshore and the prohibition of long term parking east of Pine Street. This would need to be regulated by the Council's parking ranges.

The other area of concern is people parking on the footpath on the east side of Pine Street. This is a problem all year round but also seems worse during the holidays when rental properties there attract numerous vehicles. Parking on the footpath means that pedestrians, skateboarders, scooter riders, cyclists and mobility scooters have to venture onto the very busy road to avoid cars on the footpath. I realise that parking is a difficult issue for residents and tradesmen, but extended parking on the footpath is not an acceptable solution. I also realise that this may be more of a police matter rather than a Council matter and request (if this is the case) that you bring this matter to the attention of the Traffic Committee as it is a real safety concern. In the last two weeks I have had to brake sharply to avoid a cyclist and a skateboarder on two separate occasions.



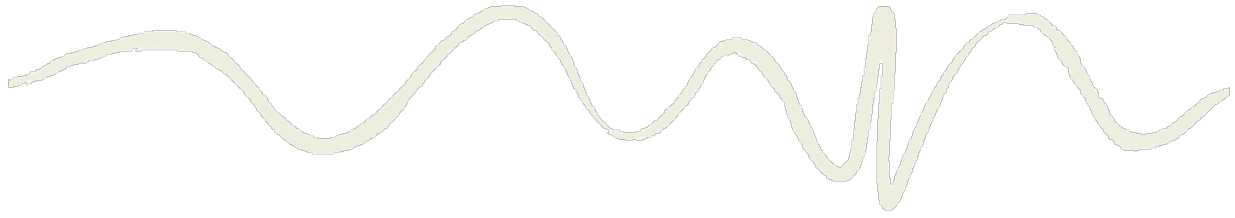

Appendix D

Recommended Site Reconfiguration Options



7.5 Traffic Issues, Hill Street/Brighton Street/Range Street/Shaws Bay Hotel and Caravan Park Entrances Area (Section B) - Road Safety Audit



General Notes:

- Signage for intersections, parking, shared paths etc. not shown, but shall be in accordance with the relevant sections of AS 1742.
- All line marking to be in accordance with AS 1742.
- Parking to be in accordance with relevant sections of AS 2890, including provision for disabled access parking bays.
- The design aims to avoid relocation of existing power poles (c), however some relocation of services and drainage structures will be necessary.

Option 1 Notes:

1. (a) Dedicated left and right turn lanes for Hill Street traffic into Park Street and Easton Place.
Note the left turn into Easton Place is not shown, but is possible with road widening.
(b) New roundabout to formalise the intersection of Park Street and Brighton Street.
2. Pedestrian refuges in accordance with Austroads.
3. Improved pedestrian connectivity through the area.
4. Additional formalised parking (may include loading/garbage truck turning bay at west end of Range Street).
5. Parking in front of shops to include disabled access, 'parents' and/or 'seniors' parking bays.
6. Formalised parking, potentially including dedicated disabled access, 'parents' and/or 'seniors' parking bays.
7. Separate left turn lane from Park Street into Hill Street.
8. Relocate bus stop and shelter to free up left turn lane into Park Street and improve intersection site distance.
9. Single entry/exist for Shaws Bay Hotel.
10. Informal overflow parking (may be formalised to maximise parking, similar to Option 3).
11. Barrier fencing to prevent pedestrians/cyclists from crossing roads in hazardous locations or falling down embankment.
12. Prevent parking in this area using bollards.

CONCEPT SKETCH ONLY

No.	Description	Date	Rev.	Appr.	DRN.

GeoLABR

This drawing shall not be relied upon for any purpose other than that for which it was prepared or for any purpose or jurisdiction other than that intended.



Labrador Head Office
PO Box 179
Labrador Head QLD 4870
Tel: 08 3687 7000

Coffs Harbour Office
PO Box 1446
Coffs Harbour NSW 2450
Tel: 02 9601 7000

Gold Coast Office
PO Box 1287
Arundel QLD 4214
Tel: 02 9772 5436

Lansvale Office
PO Box 218
Lansvale NSW 2159
Tel: 02 9673 9077

www.geolink.net.au email: info@geolink.net.au

quality solutions sustainable future

Project Title

Hill / Park / Brighton Street RSA

Client

Ballina Shire Council

Designed	NSD	Drawn	NSD	Checked	NSD
Approved	NSD	Team	02/08/2020	A/C	
Sheet					
Scale	1:1000				

Drawing Title

Option 1

Concept Sketch

Scale: 1:1000

Drawing Number

3586-SK01

7.5 **Traffic Issues, Hill Street/Brighton Street/Range Street/Shaws Bay Hotel and Caravan Park Entrances Area (Section B) - Road Safety Audit**



CONCEPT SKETCH ONLY

No.	Description	Date	By	Appr.	Sta.

GeoLINK
This drawing shall be read together with any report or other documents which may be prepared for the project or associated with the project.

GeoLINK
environmental management and design

Landcare Head Office
PO Box 119
Larsons Road, North Ballina NSW 2460
Tel: 02 9637 7000

Coffs Harbour Office
PO Box 1446
Coffs Harbour NSW 2450
Tel: 02 9637 7000

Ballina Office
PO Box 1287
Armidale NSW 2350
Tel: 02 9637 5434

Larsons Office
PO Box 128
Larsons NSW 2480
Tel: 02 9637 9577

www.geolink.net.au email: info@geolink.net.au

quality solutions sustainable future

General Notes:

- Signage for intersections, parking, shared paths etc. not shown, but shall be in accordance with the relevant sections of AS 1742.
- All line marking to be in accordance with AS 1742.
- Parking to be in accordance with relevant sections of AS 2890, including provision for disabled access parking bays.
- The design aims to avoid relocation of existing power poles (c), however some relocation of services and drainage structures will be necessary.

Option 2 Notes:

1. Roundabout to improve traffic distribution and act as traffic calming device for vehicles travelling down Hill Street. *Note that a single lane roundabout is shown but a dual lane roundabout would also be possible.*
2. Pedestrian refuges in accordance with Austroads.
3. Improved pedestrian connectivity through the area.
4. Additional parking with one-way aisle (may include loading/garbage truck turning bay at west end of Range Street).
5. Parking in front of shops to include disabled access bay and loading bays.
6. Formalised parking, potentially including dedicated disabled access, 'parents' and/or 'seniors' parking bays.
7. Left turn lane from Hill Street into Park Street.
8. Relocate bus stop and shelter.
9. Single entry/exist for Shaws Bay Hotel.
10. New parking to service North Creek Beach (aka The Serpentine Beach) will free up parking bays on the southern side of Hill Street and avoid the need for pedestrians wishing to access The Serpentine Beach to cross Hill Street.
11. Barrier fencing to prevent pedestrians/cyclists from crossing roads in hazardous locations or falling down embankment.
12. Prevent parking in this area using bollards.

Project Title
Hill / Park / Brighton Street RSA

Client
Ballina Shire Council

Designed	DATE	DRAWN	DATE	CHECKED	DATE

SCALE
1:1000

Drawing Title
Option 2 Concept Sketch

Drawing Number
3586-SK02

7.5 **Traffic Issues, Hill Street/Brighton Street/Range Street/Shaws Bay Hotel and Caravan Park Entrances Area (Section B) - Road Safety Audit**



CONCEPT SKETCH ONLY

No.	Description	Date	By	Appr.	DRN

GeoLABR

This drawing should be read in conjunction with any reports or other documents which may be prepared or to be prepared in connection with this Road Safety Audit.

GeoLINK
environmental management and design

Landcare Head Office
PO Box 119
Larsons Road, North Shore
Tel: 02 9637 7000

Cafe Caravan Office
PO Box 1446
Cafe Caravan, 10/10 ZABO
Tel: 02 9637 7000

Ballina Office
PO Box 1287
Aurora Road, North Shore
Tel: 02 9637 5434

Larsons Office
PO Box 1218
Larsons Road, North Shore
Tel: 02 9637 9577

www.geolink.net.au email: info@geolink.net.au

quality solutions sustainable future

Project Title
Hill / Park / Brighton Street RSA

Client	Ballina Shire Council
Designed	NSD
Drawn	NSD
Checked	NSD
Approved	NSD
Issue	02/06/2020
Scale	1:1000

Drawing Title
Option 3 Concept Sketch

Drawing Number
3586-SK03

General Notes:

- Signage for intersections, parking, shared paths etc. not shown, but shall be in accordance with the relevant sections of AS 1742.
- All linemarking to be in accordance with AS 1742.
- Parking to be in accordance with relevant sections of AS 2890, including provision for disabled access parking bays.
- The design aims to avoid relocation of existing power poles (c), however some relocation of services and drainage structures will be necessary.

Option 3 Notes:

1. (a) Dual lane roundabout to improve traffic distribution and provide traffic calming for vehicles travelling down Hill Street.
(b) New roundabout to formalise the intersection of Park Street and Brighton Street.
2. Pedestrian refuges in accordance with Austroads.
3. Improved pedestrian connectivity through the area.
4. Additional formalised parking (may include loading/garbage truck turning bay at west end of Range Street).
5. Parking in front of shops to include disabled access bay and loading bays.
6. Formalised parking, potentially including dedicated disabled access, 'parents' and/or 'seniors' parking bays.
7. The Serpentine widened to allow two-way traffic to the new intersection with Park Street.
8. Relocate bus stop and shelter.
9. Single entry/exist for Shaws Bay Hotel.
10. New parking to service North Creek Beach (aka The Serpentine Beach) will free up parking bays on the southern side of Hill Street and avoid the need for pedestrians wishing to access The Serpentine Beach to cross Hill Street.
11. Barrier fencing to prevent pedestrians/cyclists from crossing roads in hazardous locations or falling down embankment.
12. Possible overflow parking area.

Safe System Assessment

Section B: Hill/Park/Brighton/Range Streets

Existing Access and Parking Areas in Shaws Bay



PO Box 119
Lennox Head NSW 2478
T 02 6687 7666

PO Box 1446
Coffs Harbour NSW 2450
T 02 6651 7666

PO Box 1267
Armidale NSW 2350
T 02 6772 0454

PO Box 229
Lismore NSW 2480
T 02 6621 6677

info@geolink.net.au

Prepared for: Ballina Shire Council
© GeoLINK, 2020

7.5 Traffic Issues, Hill Street/Brighton Street/Range Street/Shaws Bay Hotel and Caravan Park Entrances Area (Section B) - Road Safety Audit

<i>UPR</i>	<i>Description</i>	<i>Date Issued</i>	<i>Issued By</i>
3586-1006	First issue	01/06/2020	MVE

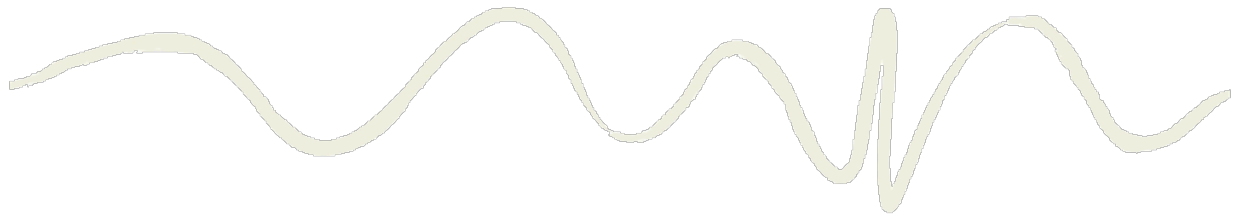

Table of Contents

1.	<u>Project Information</u>	1
1.1	<u>Background</u>	1
1.2	<u>Site Description</u>	1
1.3	<u>RSA Findings</u>	3
2.	<u>Safe System Assessment</u>	4
2.1	<u>Safe System Assessment Framework (SSAF)</u>	4
2.2	<u>Safe System Matrix</u>	5
3.	<u>Conclusions</u>	11

Tables

<u>Table 1.3</u>	<u>RSA findings and accepted actions</u>	3
<u>Table 2.1</u>	<u>Project context</u>	5
<u>Table 2.2</u>	<u>Safe System Assessment Matrix – Existing</u>	7
<u>Table 2.3</u>	<u>Safe System Assessment Matrix – Option 1</u>	8
<u>Table 2.4</u>	<u>Safe System Assessment Matrix – Option 2</u>	9
<u>Table 2.5</u>	<u>Safe System Assessment Matrix – Option 3</u>	10

Figures

<u>Figure 1.1</u>	<u>Site Locality</u>	2
<u>Figure 1.2</u>	<u>The Site</u>	2
<u>Figure 2.1</u>	<u>The Safe System</u>	4

Appendices

Appendix A Reconfiguration Options



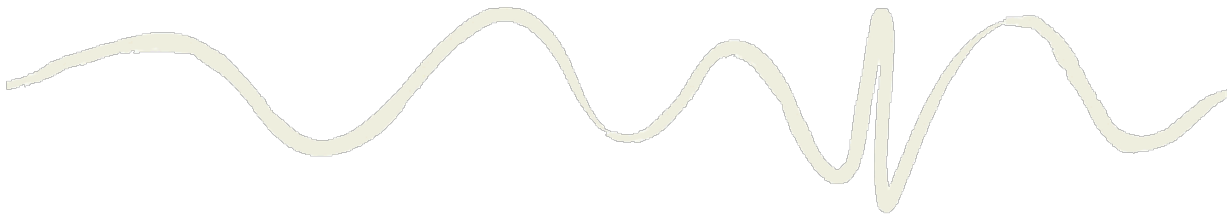

1. Project Information

1.1 Background

Ballina Shire Council (Council) has engaged GeoLINK to undertake Road Safety Audits (RSA) and Safe System Assessments (SSA) for existing roads and road-related areas in the East Ballina/Shaws Bay area.

Section A is a continuous 1.5 km stretch of road extending from the eastern end of Missingham Bridge to the change in speed zone approximately 200 m beyond the Suvla Street intersection. This roadway is known (from west to east) as Hill Street, Pine Avenue and The Coast Road. Section A includes the intersection of Hill Street and Park Street/Brighton Street, which also falls within this study.

This report is for Section B, comprising roadway, intersections, accesses, formal and informal car parking areas and pedestrian/cyclist facilities. The site is located east of and including the intersection of Hill Street and Park Street/Brighton Street. This area is partly commercial and is a popular parking area for recreational activities, particularly in summer and school holidays. The parking arrangements are known to be often chaotic with uncontrolled parking on adjacent grassed areas.

This is a particularly challenging area regarding traffic control and safety. The area is not well defined by its geometry, signage, linemarking or edges and as a result vehicle paths and turning paths are difficult to predict. The uncontrolled nature of parking on adjacent grassed areas also contributes to this lack of definition.

This report details the process and outcomes of the SSA for Section B which has been carried out following completion of the RSA for both Sections A and B.

1.2 Site Description

The site is a mix of road and road-related areas, comprising the Hill Street and Park Street intersection, Brighton Street and Range Street, as well as formal and informal parking areas. The area also provides vehicular and pedestrian/cyclist access to:

- A bus stop with shelter
- Two take-away food shops fronting Brighton Street;
- Four residential apartment blocks fronting Range Street, comprising 24 individual units in total;
- Shaws Bay Hotel and car parking area;
- Reflections Holiday Park (including caravan access);
- Existing amenities and sheltered picnic building;
- Shared path network extending north, east and south;
- Formal and informal parking areas to access the beach, parks and surrounding destinations.

The existing road pavement and surface within the study area varies from satisfactory to poor.

There are streetlights on the southern side of Hill Street at the approach to Missingham Bridge, one of which falls within the study site. There is another streetlight on the northern side of Hill Street opposite the bus shelter, however its light-spill does not reach across the road.

The speed zone on Hill Street adjacent to the site is currently 60 km/h.

7.5 Traffic Issues, Hill Street/Brighton Street/Range Street/Shaws Bay Hotel and Caravan Park Entrances Area (Section B) - Road Safety Audit

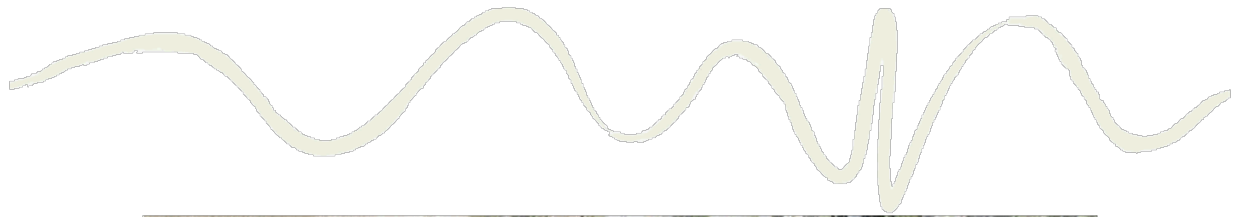

Figure 1.1 Site Locality [Source: SIX Maps]



Figure 1.2 The Site [Source: SIX Maps]



7.5 Traffic Issues, Hill Street/Brighton Street/Range Street/Shaws Bay Hotel and Caravan Park Entrances Area (Section B) - Road Safety Audit

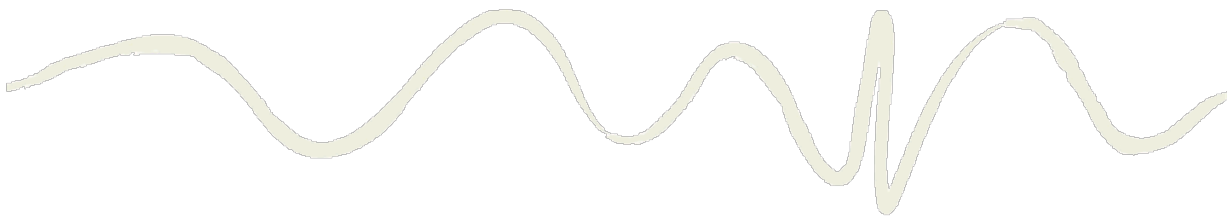

The Hill Street frontage of the site includes a shared path extending from Compton Drive to Missingham Bridge and beyond. This path links to another shared path at the south western corner of the site which extends east through the site and along the Richmond River 'North Wall'. There is another formalised path on the northern side of Hill Street, with a width of ~1.5 m. A pedestrian refuge provides connection between the two. There are no other formal paths within the site area, however much of the site appears to function as an unofficial shared zone.

The site is known to be popular with locals and visitors with an influx of beach-goers, holiday-makers and patrons to the Shaws Bay Hotel on weekends during the summer months and school holidays.

Photos of the site taken along with crash history data and letters sent to Council by concerned local residents are provided with the RSA for Section B.

1.3 RSA Findings

The existing site RSA carried out for Section B identified a number of deficiencies, providing each with a risk rating. The findings and recommendations accepted by Council are summarised below.

Table 1.1 RSA findings and accepted actions

Audit finding	Actions
<p>1.1, 1.2, 1.3, 1.5, 2.1, 2.2, 2.3, 3.1, 4.1, 4.2</p>	<p>Council will consider options to reconfigure the intersection of Hill Street / Park Street / Brighton Street in conjunction with the area to the east of Brighton Street, including formalising the Brighton Street intersection, the parking areas north and south of Brighton Street, and the pedestrian and cyclist facilities within the area, with the aims to:</p> <ul style="list-style-type: none"> ▪ Provide a right turn lane for traffic turning right off Hill Street into Brighton Street; ▪ Relocate the bus zone to avoid conflict with the left turn lane from Hill Street to Brighton Street and prevent buses from obscuring the view of motorists existing Brighton Street; ▪ Improve/increase parking provisions; ▪ Reduce confusion regarding priorities of movements through linemarking and signage; ▪ Provide better connectivity for pedestrians to cross Hill Street, particularly between Missingham Bridge and the Park Street/Brighton Street intersection; ▪ Provide better pedestrian connectivity through the Brighton Street area; and ▪ Improve street lighting.
3.2	Repair 'Shared Path' sign on the south eastern corner of the Hill / Brighton Street intersection.
4.5	The intention and appropriateness of the timber board fixed to the rear of the guard rail on the south west corner of the Hill Street / Compton Drive intersection will be investigated and compliance checked against current relevant standards.
Other (from Section A RSA)	Apply to TfNSW for a speed zone review with the intention to gain approval to reduce the speed zone from 60 km/h to 50 km/h for the full length of the Section A area, thus improving the safety of the road environment by reducing the likelihood and/or severity of potential crashes.

*Note that audit findings are colour coded according to the risk ranking determined in the RSA for the design as per the concept design plans: **Low**, **Medium**, **High**. Note also that these rankings are likely to improve (i.e. drop) with application of the agreed actions tabled above.*

Three concept designs were prepared as part of the RSA process to address many of the audit findings (**Appendix A**). All three options aim to improve the safety of the study area while maintaining or improving parking provisions and amenity. Note that all sketches are subject to detailed design and feasibility studies to address construction costs and property acquisition.



2. Safe System Assessment

2.1 Safe System Assessment Framework (SSAF)

The 'Safe System' (SS) approach is an internationally recognised holistic methodology. The key principles underpinning the SS approach are:

- People make mistakes. Humans will continue to make mistakes, and the transport system must accommodate these. The transport system should not result in death or serious injury because of errors on the roads.
- Human physical frailty. There are known physical limits to the amount of force our bodies can take before we are injured.
- A 'forgiving' road transport system. A SS ensures that the forces in collisions do not exceed the limits of human tolerance. Speeds must be managed so that humans are not exposed to impact forces beyond their physical tolerance. System designers and operators need to consider the limits of the human body in designing and maintaining roads, vehicles and speeds.
- Inclusive view of the whole road transport system and the interactions between all elements: roads and roadsides, vehicles, travel speeds and all users of the system.

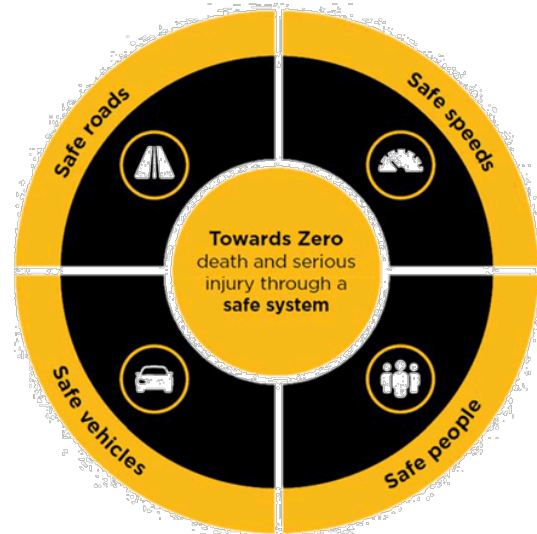

Figure 2.1 The Safe System
[Source: Transport for NSW, 2018]

SS principles recognise that human error in the road environment is inevitable and that road infrastructure should accommodate this error and minimise the consequences. The aim is to eliminate any crash resulting in a fatality or serious injury (FSI) by implementing:

- Safer roads;
- Safer vehicles;
- Safer road users; and
- Safer speeds.

The *National Road Safety Strategy 2011-2020* (Australian Transport Council, 2011) and the *NSW Road Safety Strategy 2012-2021* (Transport for NSW, 2012) outline a commitment to the adoption and implementation of the SS approach. As a result of this, it is now expected that road safety processes and procedures, including RSAs, be implemented to ensure a high alignment with the SS principles.

While RSAs are proven to reduce road trauma (AGRS06, 2019), they have traditionally focused on a safety-in-design approach and identifying risks and hazards associated with all crash types and severities. However, the SS approach aims to prioritise eliminating FSI crashes.

The SSAF was developed by Austroads to facilitate the incorporation of SS objectives in all road infrastructure and traffic management projects. A SSA is a proactive tool within the framework which

7.5 Traffic Issues, Hill Street/Brighton Street/Range Street/Shaws Bay Hotel and Caravan Park Entrances Area (Section B) - Road Safety Audit

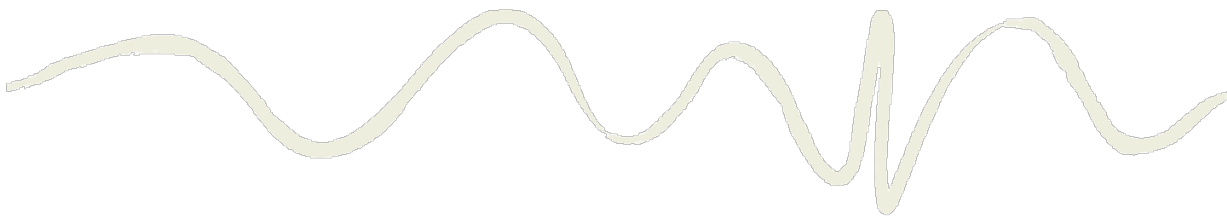

uses a matrix to ensure consistent consideration of major crash types and prompts an assessment of crash severity, road user exposure and crash likelihood as they apply to each crash type. It can be carried out on a wide variety of project types and at any stage across the lifespan of a project (planning, design, operation and maintenance).

The main stages of the SSAF are:

- Identification of objectives;
- Setting the context;
- Applying the SS matrix; and
- Applying a treatment hierarchy and selection process (not required for this assessment).

The depth of assessment and analysis in a SSA should reflect the project size, complexity and risk of FSI crashes.

The intention of identifying the project context as per **Table 2.1** is to ensure that each aspect of the SS is considered as part of the system (refer **Figure 2.1**).

Table 2.1 Project context

Prompt	Comments
Reason for the project	Improve safety, efficiency and amenity within the study area.
Function of the road	Hill Street: part of alternative arterial road between Lennox Head and Ballina East of Hill/Brighton intersection: Access to shops, residential units, Shaws Bay Hotel, Reflections Holiday Park, recreational/shared pathways, beaches, picnic areas, parking areas.
Speed environment	Hill Street: 60km/h as signposted. East of Hill/Brighton intersection: Generally below 20km/h
Road users	Commuters, service vehicles, tourists, picnic/beach-goers, sports and recreation, parents doing school run, school/public buses, pedestrians, cyclists.
Vehicle composition	Motor vehicle traffic, including motorcyclists, with very low percentage of heavy vehicles Pedestrians and cyclists using off-road pathways and roadways, some cyclists using vehicle travel lanes

2.2 Safe System Matrix

In order to ensure that SS elements are considered, or to measure how well a given project aligns with SS principles, a SS matrix has been produced. The purpose of the matrix is to assess major crash types identified as the predominant contributors to FSI outcomes against the exposure to that crash risk, the likelihood of it occurring and the severity of the crash should it occur.

Exposure, likelihood and severity (the rows of the matrix) are defined by Austroads as follows:

- **Road user exposure:** this refers to which road users, in what numbers and for how long they are using the road and are thus exposed to a potential crash. The measures of exposure include AADT, side-road traffic volumes, number of motorcycles, cyclists and pedestrians crossing or walking along the road, length of the road, area and length of time.
- **Crash likelihood:** groups of factors affecting the probability of a crash occurring. They can be elements which moderate opportunity for conflict, such as the number of conflict points, offset to roadside hazards, and separation between opposing traffic. They can also include elements of road user behaviour and/or road environment. Typically, these are the elements which moderate

7.5 Traffic Issues, Hill Street/Brighton Street/Range Street/Shaws Bay Hotel and Caravan Park Entrances Area (Section B) - Road Safety Audit

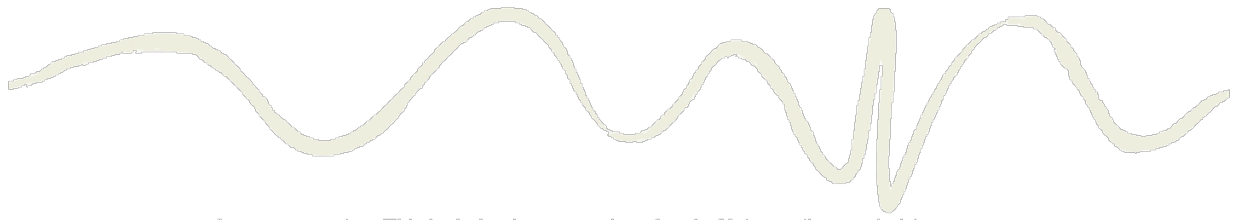

road user error rates. This includes issues such as level of intersection control (e.g. priority/signals/movement ban), speed, sight distance, geometric alignment, driver guidance and warning, and maintenance.

- **Crash severity:** groups of factors affecting the probability of severe injury outcomes should a crash occur. Typically, these factors are associated with the amount of kinetic energy and its transfer in the crash, e.g. impact speeds and angles, severity of roadside hazards.

The matrix columns show the following major crash types:

- Run-off-road (also referred to as 'loss of control', or 'off path on curve/straight')
- Head-on (or 'vehicles from opposing directions')
- Intersection ('vehicles from adjacent directions')
- Other (this incorporates all same direction, manoeuvring, overtaking, on path and other crashes)
- Pedestrian
- Cyclist
- Motorcyclist

A score between zero and four (0-4) is subjectively determined for each cell based on site specific information available at the time of assessment. Zero indicates full alignment with the SS objectives for that component of the risk (exposure, likelihood or severity) for the given crash type or the absence of that category (e.g. no pedestrians). The higher the score, the further away the project is from SS principles. Comments providing a rationale for each score are also provided where deemed appropriate.

Once a score is provided in each cell, the product of each column is calculated and entered in the final row. The purpose of this multiplicative approach is that if a score of zero has been given for any component of a crash type (i.e. exposure, likelihood or severity), that crash type receives a total of zero and is eliminated from the score (as it has reached a SS condition).

The Austroads guidelines suggest that a project with a crash type score of less than 16 can be considered highly-aligned with the SS for that crash type. A design can be considered moderately-aligned between 16 and 32, and poorly-aligned above 32.

The sum of the scores for each crash type is added to calculate the total SSAF score out of a possible 448. It represents the contribution of 'safe speeds' and 'safe roads/roadsides' to the SS for the project.

Total SSAF scores of less than 112 are considered highly-aligned, 112 to 224 are considered moderately-aligned, and above 224 are considered poorly-aligned.

The focus of the SS matrix is on the assessment of infrastructure, and as such, more attention is given to road and roadside infrastructure and vehicle speeds. The road users and vehicle types involved are also considered along with post-crash care, however in many cases, road user and vehicle-related changes will be outside the scope of the project.

A SS Assessment Matrix has been prepared for the existing study area (

). It has then been reproduced to reassess the same area for the reconfiguration Options 1, 2 and 3 (**Appendix A**), thus allowing comparison of the four scenarios: 'Do nothing', 'Option 1', 'Option 2', and 'Option 3'. Note that the three reconfiguration options assume the speed limit has dropped to 50 km/h.

The matrices for the reconfiguration options, **Tables 2.3, 2.4 and 2.5** highlight in **red** where the assessment differs from the baseline (existing) case.

7.5 **Traffic Issues, Hill Street/Brighton Street/Range Street/Shaws Bay Hotel and Caravan Park Entrances Area (Section B) - Road Safety Audit**

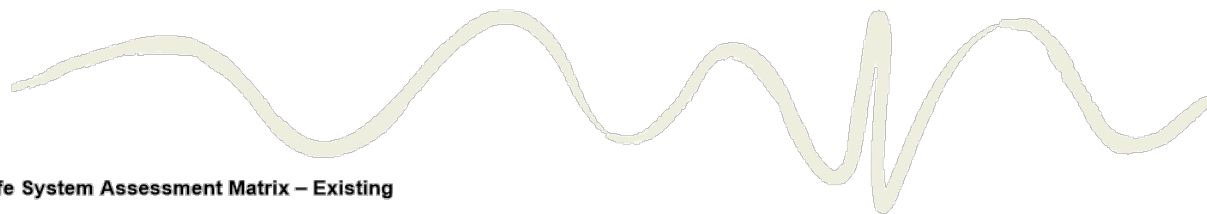

Table 2.2 Safe System Assessment Matrix – Existing

	<i>Run-off-road</i>	<i>Head-on</i>	<i>Intersection</i>	<i>Other</i>	<i>Pedestrian</i>	<i>Cyclists</i>	<i>Motorcyclist</i>
<i>Road User Exposure</i>	2 / 4	2 / 4	2 / 4	2 / 4	4 / 4	4 / 4	2 / 4
<i>Crash Likelihood</i>	2 / 4	3 / 4	3 / 4	3 / 4	4 / 4	4 / 4	3 / 4
<i>Crash Severity</i>	2 / 4	2 / 4	2 / 4	2 / 4	4 / 4	4 / 4	3 / 4
Product	8 / 64	12 / 64	12 / 64	12 / 64	64 / 64	64 / 64	18 / 64

Total SSAF Score = 190 / 448

Additional SS Component	Comment
<i>Road users</i>	<ul style="list-style-type: none"> High volume of all road user groups. Road users likely to be alert and compliant due to proximity to roundabout west of Missingham Bridge and roundabout at Angels Beach Drive. Numerous distractions in roadside environment – signs, advertising, pedestrians etc. Proximity to Shaws Bay Hotel may result in drunk drivers and/or pedestrians using the road. Highly popular area for families with young children. Pedestrians observed crossing illegally. Confusing layout and unclear priorities east of Hill Street / Brighton Street intersection. Special road users may include travellers, some with caravans – unfamiliar with the area and likely to be unpredictable.
<i>Vehicles</i>	<ul style="list-style-type: none"> Very low percentage of heavy vehicles, but some services vehicles associated with take-away food shops and the Shaws Bay Hotel. Existing roadway in very poor condition. Parking areas informal and confusing. Through vehicles observed treating the area as a 'main road'. 60 km/h speed zone potentially sending wrong message to road users.
<i>Post-crash care</i>	<ul style="list-style-type: none"> Access by emergency vehicles relatively clear with sufficient width available in roadway between the site and CBD, however congestion of the area is often experienced, roads are known by different names and locations are difficult to describe. Hospital and ambulance/fire/police stations all located in Ballina (2-3km travel distance). Westpac Life Saver Rescue Helicopter operates in the area. VMS (variable message signs) available for deployment and broadcasts on local radio stations possible to warn road users of an incident.



7.5 Traffic Issues, Hill Street/Brighton Street/Range Street/Shaws Bay Hotel and Caravan Park Entrances Area (Section B) - Road Safety Audit

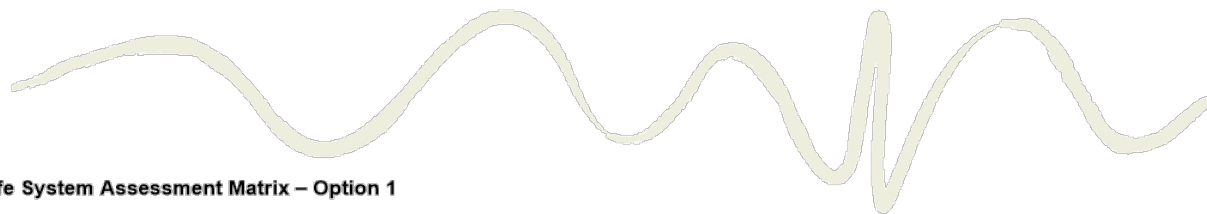

Table 1.3 Safe System Assessment Matrix – Option 1

	Run-off-road	Head-on	Intersection	Other	Pedestrian	Cyclists	Motorcyclist
Road User Exposure	2 / 4	2 / 4	2 / 4	2 / 4	4 / 4	4 / 4	2 / 4
Crash Likelihood	2 / 4	3 / 4	2 / 4	2 / 4	2 / 4	2 / 4	2 / 4
Crash Severity	1 / 4	2 / 4	2 / 4	1 / 4	3 / 4	2 / 4	2 / 4
Product	4 / 64	12 / 64	8 / 64	4 / 64	24 / 64	16 / 64	8 / 64

Total SSAF Score = 76 / 448

Additional SS Component	Comment
Road users	<ul style="list-style-type: none"> High volume of all road user groups. Road users likely to be alert and compliant due to proximity to roundabout west of Missingham Bridge and roundabout at Angels Beach Drive. Numerous distractions in roadside environment – signs, advertising, pedestrians etc. Improved road environment due to reconfiguration of Hill Street and intersections between Missingham Bridge and Compton Drive, particularly formalising the area east of the Hill Street / Brighton Street intersection and relocation of bus bay. Proximity to Shaws Bay Hotel may result in drunk drivers and/or pedestrians using the road. Highly popular area for families with young children. Pedestrians observed crossing illegally. However, improvements to pedestrian connectivity and facilities encourage better behaviour. Clear layout and priorities at intersections. Turning lanes at intersection improve efficiency. Special road users may include travellers, some with caravans – unfamiliar with the area and likely to be unpredictable.
Vehicles	<ul style="list-style-type: none"> Very low percentage of heavy vehicles, but some services vehicles associated with take-away food shops and the Shaws Bay Hotel. Existing roadway in good condition (assumed new). Parking areas formalised and improved, including barriers to no parking areas. 50 km/h zone more appropriate for adjacent land uses and high pedestrian activity area. Gives message to road users that it is a local road.
Post-crash care	<ul style="list-style-type: none"> Access by emergency vehicles relatively clear with sufficient width available in roadway between the site and CBD, however congestion of the area is often experienced, roads are known by different names and locations are difficult to describe. Hospital and ambulance/fire/police stations all located in Ballina (2-3km travel distance). Westpac Life Saver Rescue Helicopter operates in the area. VMS (variable message signs) available for deployment and broadcasts on local radio stations possible to warn road users of an incident.



7.5 **Traffic Issues, Hill Street/Brighton Street/Range Street/Shaws Bay Hotel and Caravan Park Entrances Area (Section B) - Road Safety Audit**

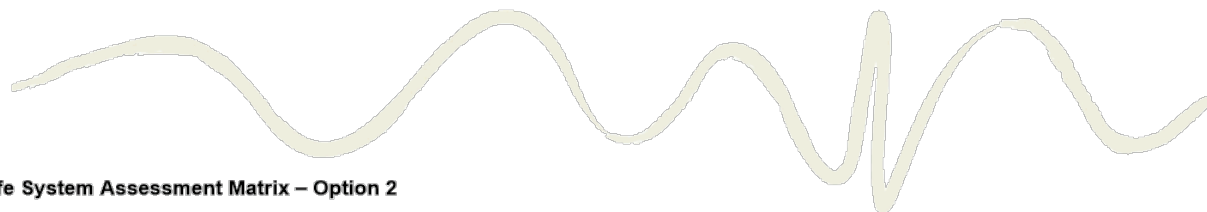

Table 1.4 Safe System Assessment Matrix – Option 2

	<i>Run-off-road</i>	<i>Head-on</i>	<i>Intersection</i>	<i>Other</i>	<i>Pedestrian</i>	<i>Cyclists</i>	<i>Motorcyclist</i>
<i>Road User Exposure</i>	2 / 4	2 / 4	2 / 4	2 / 4	4 / 4	4 / 4	2 / 4
<i>Crash Likelihood</i>	2 / 4	2 / 4	2 / 4	1 / 4	2 / 4	2 / 4	2 / 4
<i>Crash Severity</i>	1 / 4	1 / 4	2 / 4	1 / 4	3 / 4	2 / 4	2 / 4
Product	4 / 64	4 / 64	8 / 64	2 / 64	24 / 64	16 / 64	8 / 64

Total SSAF Score = 66 / 448

Additional SS Component	Comment
<i>Road users</i>	<ul style="list-style-type: none"> ▪ High volume of all road user groups. ▪ Road users likely to be alert and compliant due to proximity to roundabout west of Missingham Bridge and roundabout at Angels Beach Drive. ▪ Numerous distractions in roadside environment – signs, advertising, pedestrians etc. ▪ Improved road environment due to reconfiguration of Hill Street and intersections between Missingham Bridge and Compton Drive, particularly formalising the area east of the Hill Street / Brighton Street intersection and relocation of bus bay. ▪ Proximity to Shaws Bay Hotel may result in drunk drivers and/or pedestrians using the road. ▪ Highly popular area for families with young children. ▪ Pedestrians observed crossing illegally. However, improvements to pedestrian connectivity and facilities encourage better behaviour. ▪ Clear layout and priorities at intersections. ▪ Roundabout on Hill Street forces traffic to slow down. ▪ Turning lanes at intersection improve efficiency. ▪ Special road users may include travellers, some with caravans – unfamiliar with the area and likely to be unpredictable.
<i>Vehicles</i>	<ul style="list-style-type: none"> ▪ Very low percentage of heavy vehicles, but some services vehicles associated with take-away food shops and the Shaws Bay Hotel. ▪ Existing roadway in good condition (assumed new). ▪ Parking areas formalised and improved. Abundant parking results in less circulating traffic looking for somewhere to park. ▪ 50 km/h zone more appropriate for adjacent land uses and high pedestrian activity area. Gives message to road users that it is a local road.
<i>Post-crash care</i>	<ul style="list-style-type: none"> ▪ Access by emergency vehicles relatively clear with sufficient width available in roadway between the site and CBD, however congestion of the area is often experienced, roads are known by different names and locations are difficult to describe. ▪ Hospital and ambulance/fire/police stations all located in Ballina (2-3km travel distance). ▪ Westpac Life Saver Rescue Helicopter operates in the area. ▪ VMS (variable message signs) available for deployment and broadcasts on local radio stations possible to warn road users of an incident.



7.5 Traffic Issues, Hill Street/Brighton Street/Range Street/Shaws Bay Hotel and Caravan Park Entrances Area (Section B) - Road Safety Audit

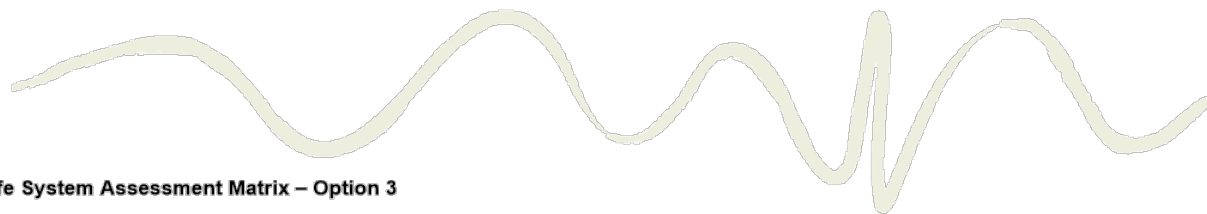

Table 1.5 Safe System Assessment Matrix – Option 3

	Run-off-road	Head-on	Intersection	Other	Pedestrian	Cyclists	Motorcyclist
Road User Exposure	2 / 4	2 / 4	2 / 4	2 / 4	4 / 4	4 / 4	2 / 4
Crash Likelihood	2 / 4	2 / 4	1 / 4	1 / 4	2 / 4	2 / 4	2 / 4
Crash Severity	1 / 4	1 / 4	1 / 4	1 / 4	3 / 4	2 / 4	2 / 4
Product	4 / 64	4 / 64	2 / 64	2 / 64	24 / 64	16 / 64	8 / 64

Total SSAF Score = 60 / 448

Additional SS Component	Comment
Road users	<ul style="list-style-type: none"> High volume of all road user groups. Road users likely to be alert and compliant due to proximity to roundabout west of Missingham Bridge and roundabout at Angels Beach Drive. Numerous distractions in roadside environment – signs, advertising, pedestrians etc. Improved road environment due to reconfiguration of Hill Street and intersections between Missingham Bridge and Compton Drive, particularly formalising the area east of the Hill Street / Brighton Street intersection and relocation of bus bay. Proximity to Shaws Bay Hotel may result in drunk drivers and/or pedestrians using the road. Highly popular area for families with young children. Pedestrians observed crossing illegally. However, improvements to pedestrian connectivity and facilities encourage better behaviour. Clear layout and priorities at intersections. Roundabout on Hill Street forces traffic to slow down. Turning lanes at intersection improve efficiency. Special road users may include travellers – unfamiliar with the area and likely to be unpredictable.
Vehicles	<ul style="list-style-type: none"> Very low percentage of heavy vehicles, but some services vehicles associated with take-away food shops and the Shaws Bay Hotel. Existing roadway in good condition (assumed new). Parking areas formalised and improved. Abundant parking results in less circulating traffic looking for somewhere to park. 50 km/h zone more appropriate for adjacent land uses and high pedestrian activity area. Gives message to road users that it is a local road.
Post-crash care	<ul style="list-style-type: none"> Access by emergency vehicles relatively clear with sufficient width available in roadway between the site and CBD, however congestion of the area is often experienced, roads are known by different names and locations are difficult to describe. Hospital and ambulance/fire/police stations all located in Ballina (2-3km travel distance). Westpac Life Saver Rescue Helicopter operates in the area. VMS (variable message signs) available for deployment and broadcasts on local radio stations possible to warn road users of an incident.



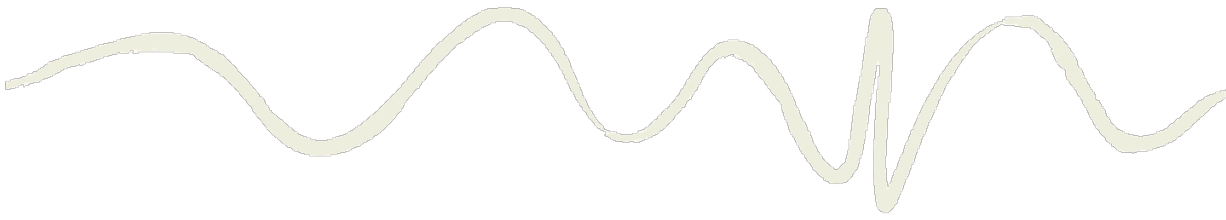

3. Conclusions

The existing area described herein as Section B, comprising the Hill Street / Brighton Street intersection and the roadway area to the east is found to be moderately aligned with the Safe System Assessment Framework in accordance with the relevant Austroads road safety guidelines (2019) and the Austroads research report, *Safe System Assessment Framework* (2016).

The existing study area described as Section B achieves a SSAF score of 190 out of 448.

The assessment carried out for each of the three reconfiguration options including the accepted recommendations proposed by the RSA and listed in Table 1.1 RSA findings and accepted actions **Table 1.1** of this report indicates that all three options would improve the study area to be highly aligned with the SSAF, with SSAF scores as follows:

- Option 1 – 76 / 448
- Option 2 – 66 / 448
- Option 3 – 60 / 448

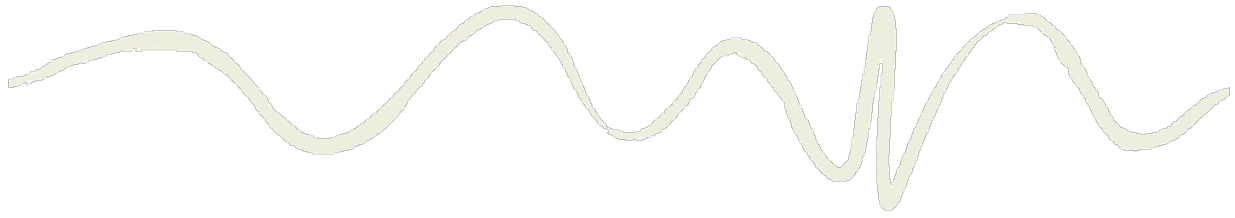

Copyright and Usage

©GeoLINK, 2020

This document, including associated illustrations and drawings, was prepared for the exclusive use of Ballina Shire Council. It is not to be used for any other purpose or by any other person, corporation or organisation without the prior consent of GeoLINK. GeoLINK accepts no responsibility for any loss or damage suffered howsoever arising to any person or corporation who may use or rely on this document for a purpose other than that described above.

This document, including associated illustrations and drawings, may not be reproduced, stored, or transmitted in any form without the prior consent of GeoLINK. This includes extracts of texts or parts of illustrations and drawings.



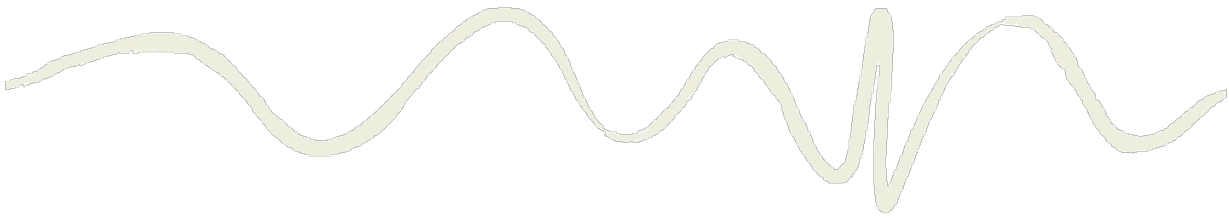

Appendix A

Reconfiguration Options



7.5 Traffic Issues, Hill Street/Brighton Street/Range Street/Shaws Bay Hotel and Caravan Park Entrances Area (Section B) - Road Safety Audit



General Notes:

- Signage for intersections, parking, shared paths etc. not shown, but shall be in accordance with the relevant sections of AS 1742.
- All line marking to be in accordance with AS 1742.
- Parking to be in accordance with relevant sections of AS 2890, including provision for disabled access parking bays.
- The design aims to avoid relocation of existing power poles (c), however some relocation of services and drainage structures will be necessary.

Option 1 Notes:

1. (a) Dedicated left and right turn lanes for Hill Street traffic into Park Street and Easton Place.
Note the left turn into Easton Place is not shown, but is possible with road widening.
(b) New roundabout to formalise the intersection of Park Street and Brighton Street.
2. Pedestrian refuges in accordance with Austroads.
3. Improved pedestrian connectivity through the area.
4. Additional formalised parking (may include loading/garbage truck turning bay at west end of Range Street).
5. Parking in front of shops to include disabled access, 'parents' and/or 'seniors' parking bays.
6. Formalised parking, potentially including dedicated disabled access, 'parents' and/or 'seniors' parking bays.
7. Separate left turn lane from Park Street into Hill Street.
8. Relocate bus stop and shelter to free up left turn lane into Park Street and improve intersection site distance.
9. Single entry/exist for Shaws Bay Hotel.
10. Informal overflow parking (may be formalised to maximise parking, similar to Option 3).
11. Barrier fencing to prevent pedestrians/cyclists from crossing roads in hazardous locations or falling down embankment.
12. Prevent parking in this area using bollards.

CONCEPT SKETCH ONLY

No.	Description	Date	Rev.	Appr.	DRN.

GeoLINK
This drawing shall not be relied upon for any purpose other than that for which it was prepared or for any purpose or consideration other than that intended.

GeoLINK
environmental management and design

Landcare Head Office
PO Box 179
Larsons Road NSW 2480
Tel: 02 9671 7000

Coffs Harbour Office
PO Box 1446
Coffs Harbour NSW 2450
Tel: 02 9671 7000

Ballina Office
PO Box 1287
Armidale NSW 2350
Tel: 02 9671 5436

Larsons Office
PO Box 128
Larsons NSW 2480
Tel: 02 9671 9077

www.geolink.net.au email: info@geolink.net.au

quality solutions sustainable future

Project Title: Hill / Park / Brighton Street RSA

Client: Ballina Shire Council

Designed	NSD	Drawn	NSD	Checked
Approved	NSD	Team	22/03/2020	AJC
Sheet				
Scale				

Drawing Title: Option 1 Concept Sketch

Drawing Number: 3586-SK01

7.5 **Traffic Issues, Hill Street/Brighton Street/Range Street/Shaws Bay Hotel and Caravan Park Entrances Area (Section B) - Road Safety Audit**



CONCEPT SKETCH ONLY

No.	Description	Date	Rev.	Appr.	DRN.

GeoLAB

This drawing shall be read together with any report or other documents which may be prepared for the project or associated with the project.

GeoLINK
environmental management and design

Landcare Head Office
PO Box 178
Larsons Road, North Ballina NSW 2467
Tel: 02 9637 7000

Coffs Harbour Office
PO Box 1446
Coffs Harbour NSW 2450
Tel: 02 9637 7000

Ballina Office
PO Box 1287
Armidale NSW 2350
Tel: 02 9637 5436

Larsons Office
PO Box 128
Larsons NSW 2480
Tel: 02 9637 9577

www.geolink.net.au email: info@geolink.net.au

quality solutions sustainable future

Project Title
Hill / Park / Brighton Street RSA

Client
Ballina Shire Council

Designed	NSD	Drawn	NSD	Checked	NSD
Approved	NSD	Team	22/06/2020	A/C	
Sheet					
Scale	1:1000				

Drawing Title
Option 2 Concept Sketch

Drawing Number
3586-SK02

General Notes:

- Signage for intersections, parking, shared paths etc. not shown, but shall be in accordance with the relevant sections of AS 1742.
- All line marking to be in accordance with AS 1742.
- Parking to be in accordance with relevant sections of AS 2890, including provision for disabled access parking bays.
- The design aims to avoid relocation of existing power poles (c), however some relocation of services and drainage structures will be necessary.

Option 2 Notes:

1. Roundabout to improve traffic distribution and act as traffic calming device for vehicles travelling down Hill Street. *Note that a single lane roundabout is shown but a dual lane roundabout would also be possible.*
2. Pedestrian refuges in accordance with Austroads.
3. Improved pedestrian connectivity through the area.
4. Additional parking with one-way aisle (may include loading/garbage truck turning bay at west end of Range Street).
5. Parking in front of shops to include disabled access bay and loading bays.
6. Formalised parking, potentially including dedicated disabled access, 'parents' and/or 'seniors' parking bays.
7. Left turn lane from Hill Street into Park Street.
8. Relocate bus stop and shelter.
9. Single entry/exist for Shaws Bay Hotel.
10. New parking to service North Creek Beach (aka The Serpentine Beach) will free up parking bays on the southern side of Hill Street and avoid the need for pedestrians wishing to access The Serpentine Beach to cross Hill Street.
11. Barrier fencing to prevent pedestrians/cyclists from crossing roads in hazardous locations or falling down embankment.
12. Prevent parking in this area using bollards.

7.5 **Traffic Issues, Hill Street/Brighton Street/Range Street/Shaws Bay Hotel and Caravan Park Entrances Area (Section B) - Road Safety Audit**



General Notes:

- Signage for intersections, parking, shared paths etc. not shown, but shall be in accordance with the relevant sections of AS 1742.
- All linemarking to be in accordance with AS 1742.
- Parking to be in accordance with relevant sections of AS 2890, including provision for disabled access parking bays.
- The design aims to avoid relocation of existing power poles (c), however some relocation of services and drainage structures will be necessary.

Option 3 Notes:

1. (a) Dual lane roundabout to improve traffic distribution and provide traffic calming for vehicles travelling down Hill Street.
(b) New roundabout to formalise the intersection of Park Street and Brighton Street.
2. Pedestrian refuges in accordance with Austroads.
3. Improved pedestrian connectivity through the area.
4. Additional formalised parking (may include loading/garbage truck turning bay at west end of Range Street).
5. Parking in front of shops to include disabled access bay and loading bays.
6. Formalised parking, potentially including dedicated disabled access, 'parents' and/or 'seniors' parking bays.
7. The Serpentine widened to allow two-way traffic to the new intersection with Park Street.
8. Relocate bus stop and shelter.
9. Single entry/exist for Shaws Bay Hotel.
10. New parking to service North Creek Beach (aka The Serpentine Beach) will free up parking bays on the southern side of Hill Street and avoid the need for pedestrians wishing to access The Serpentine Beach to cross Hill Street.
11. Barrier fencing to prevent pedestrians/cyclists from crossing roads in hazardous locations or falling down embankment.
12. Possible overflow parking area.

CONCEPT SKETCH ONLY

No.	Description	Date	Rev.	Appr.	DRN.

GeoLABR

This drawing shall be read in conjunction with any reports or other documents which may be prepared or to be prepared in connection with this project.

GeoLINK
environmental management and design

Landcare Head Office
PO Box 119
Larsons Road, North Ballina NSW
Tel: 02 3667 7000

Coffs Harbour Office
PO Box 1446
Coffs Harbour NSW 2450
Tel: 02 9601 7000

Ballina Office
PO Box 1287
Armidale NSW 2350
Tel: 02 9712 5434

Larsons Office
PO Box 218
Larsons NSW 2480
Tel: 02 9673 9577

www.geolink.net.au email: info@geolink.net.au

quality solutions sustainable future

Project Title
Hill / Park / Brighton Street RSA

Designed	NSD	Drawn	NSD	Checked	NSD
Approved	NSD	Team	22/03/2020	A/C	
Sheet					
Scale	1:1000				

Drawing Title
Option 3 Concept Sketch

Drawing Number
3586-SK03