

# Ballina Shire Car Parking Contributions Plan 2014

Prepared for:

Ballina Shire Council

Date: May 2014

Project No 10084



# Ballina Shire Car Parking Contributions Plan 2014

Prepared for



By



GLN Planning Pty Ltd  
ABN 39 585 269 237

Level 10, 66 King Street Sydney NSW 2000  
GPO Box 5013 Sydney NSW 2001

P [02] 9249 4100  
F [02] 9249 4111

E [info@glnplanning.com.au](mailto:info@glnplanning.com.au)  
W [glnplanning.com.au](http://glnplanning.com.au)

## Ballina Shire Car Parking Contributions Plan 2014

Ballina Shire Council

GLN Planning Pty Ltd  
ABN 39 585 269 237

Level 10, 66 King Street Sydney NSW 2000  
GPO Box 5013 Sydney NSW 2001

P	[02] 9249 4100	E	<a href="mailto:info@glnplanning.com.au">info@glnplanning.com.au</a>
F	[02] 9249 4111	W	glnplanning.com.au



Date of Final Issue: May 2014  
File Path: R:\Projects\10084 Ballina Car Parking Section 94 Plan\Reports\10084 CP final 20140219.docx  
Project Manager: G New  
Client: Ballina Shire Council  
Project Number: 10084

The purpose for which this report may be used and relied upon is limited for that which it was commissioned. Copyright in the whole and every part of this document belongs to GLN Planning and may not be used, sold, transferred, copied or reproduced in whole or in part in any manner or form or in or on any media to any person without the prior written consent of GLN Planning.

## Table of Contents

<b>1.0</b>	<b>Summary</b>	<b>1</b>
1.1	Plan overview	1
1.2	Summary of contribution rates	2
1.3	Calculating a contribution under this Plan	2
<b>2.0</b>	<b>Administration and operation of this Plan</b>	<b>5</b>
2.1	Definitions	5
2.2	Name of Plan	6
2.3	Purposes of Plan	6
2.4	Local Infrastructure addressed by this Plan	7
2.5	Commencement of Plan	7
2.6	Land to which this Plan applies	7
2.7	Development to which this Plan applies	7
2.8	Development exempted from contributions under this Plan	7
2.9	Relationship to other contributions plans	7
2.10	Contributions may be required as a condition of consent	8
2.11	Dedication of land free of cost may be required as a condition of consent	8
2.12	Other contributions to be taken into account	8
2.13	Obligations of Accredited Certifiers	9
	2.13.1 Complying Development Certificates	9
	2.13.2 Construction Certificates	11
2.14	Indexation of contribution rates	11
2.15	Indexation of contributions required by a condition imposed under this Plan	12
2.16	Timing of payment of contributions	12
2.17	Policy on deferred or periodic payments	13
2.18	Reassessment of contributions	13
2.19	Works in kind and other material public benefits	14
	2.19.1 Matters for Council's consideration	14
	2.19.2 Agreements	15
	2.19.3 Valuation of offers	15
2.20	Goods and Services Tax (GST)	15
2.21	Accountability and access to information	15
2.22	Review of Plan without the need for public exhibition	16
2.23	Savings and transitional arrangements	16
<b>3.0</b>	<b>Car parking demands and infrastructure programs</b>	<b>17</b>
3.1	Council's role in providing parking in town centres	17
3.2	Expected Non Residential Development	17
	3.2.1 Overview	17
	3.2.2 Ballina CBD	20
	3.2.3 Lennox Head Village Centre	20
	3.2.4 Alstonville Village Centre	21
3.3	Nexus	21

3.3.1	Causal nexus	21
3.3.2	Spatial nexus	21
3.3.3	Temporal nexus	22
3.4	Contribution rate formula	22
3.5	Infrastructure costs	23
3.6	Car parking infrastructure strategies	23
3.6.1	How will the car parking facilities be delivered?	23
3.6.2	Ballina CBD infrastructure program	24
3.6.3	Lennox Head Village Centre infrastructure program	26
3.6.4	Alstonville Village Centre infrastructure program	28

## Tables

Table 1-1	Summary of contribution rates	2
Table 3-1	Ballina CBD car parking infrastructure program	26
Table 3-2	Lennox Head Village Centre car parking infrastructure program	27
Table 3-3	Alstonville Village Centre car parking infrastructure program	29

## Figures

Figure 1-1	Ballina CBD contribution catchment area (shown dashed)	3
Figure 1-2	Lennox Head Village Centre contribution catchment area (shown dashed)	3
Figure 1-3	Alstonville Village Centre contribution catchment area (shown dashed)	4
Figure 3-1	Ballina LGA Commercial Hierarchy	18
Figure 3-2	Method of travelling to work - Ballina Shire LGA (2011)	19
Figure 3-3	Commercial Land Audit Projections of Demand and Land Supply Buffer	20
Figure 3-4	Aerial Photo identifying Wigmore Arcade Car Park at 84 Tamar Street, Ballina	24
Figure 3-5	Location of proposed car parks at No.74 and No.78 Tamar Street, Ballina	25
Figure 3-6	Lennox Head Village Centre car parking infrastructure location	28
Figure 3-7	Alstonville Village Centre car parking infrastructure location	30

## Appendices

Appendix A:	Preliminary car parking infrastructure plans – Multi-storey car park (Tamar St)
Appendix B:	Preliminary car parking infrastructure plans – 78 Tamar Street, Ballina
Appendix C:	Preliminary car parking infrastructure plans – 74 Tamar Street, Ballina
Appendix D:	Preliminary car parking infrastructure plans – Alstonville Village Centre

## 1.0 Summary

### 1.1 Plan overview

Future development in the town centres of Ballina LGA will place an increasing demand on the car parking facilities within those centres. The existing supply of car parking infrastructure – whether by Ballina Shire Council (**Council**) or on the development sites - has generally been designed to accommodate the existing development.

New development is generally required to meet its own car parking demands. Occasionally however it is not possible for all of the parking demands to be met through on-site provision of car spaces. In the past, Council has collected cash contributions from such developments and provided the shortfall spaces in public car parking structures. This contributions plan enables the Council to continue this practice for developments that are deficient in parking in the Ballina, Lennox Head and Alstonville centres.

The *Environmental Planning and Assessment Act 1979 (EP&A Act)* allows Consent Authorities to grant consent to developments subject to a condition requiring a (section 94) contribution for the provision, extension or augmentation of Local Infrastructure in the area, or toward the recoupment of the cost of existing Local Infrastructure in the area.

Where the Consent Authority is a council or an Accredited Certifier, a Local Infrastructure Contribution may be imposed on a development only if it is of a kind allowed by and determined in accordance with a contributions plan, such as this Plan.

This Plan authorises Council or an Accredited Certifier to impose conditions on Development Consents or Complying Development Certificates requiring section 94 contributions from Non Residential Development that results in an increase in gross floor area (**GFA**) on land shown in Figures 1-1, 1-2 and 1-3 of this Plan.

This Plan has been prepared in accordance with the EP&A Act and *Environmental Planning and Assessment Regulation 2000 (EP&A Regulation)*; and having regard to the latest Practice Notes issued by the NSW Department of Planning.

This Plan sets out:

- the relationship or nexus between the expected development in the town centres identified within this Plan and the car parking infrastructure that is required to meet the demands of that development;
- the general formula used to determine the reasonable section 94 contributions required from expected development for the provision of car parking facilities;
- the monetary contribution rates for the specified town centres;
- maps showing the location of the car parking facilities already provided, or proposed to be provided, by Council supported by a works schedule setting out an estimate of their cost and staging; and
- the administrative and accounting arrangements applying to contributions that are required by this Plan.

## 1.2 Summary of contribution rates

**Table 1-1 Summary of contribution rates**

Town Centre	Contribution Rate per car parking space
Ballina Central Business District (CBD)	<b>\$25,368</b>
Lennox Head Village Centre	<b>\$15,999</b>
Alstonville Village Centre	<b>\$14,722</b>

The contribution rates are accurate at the date that this Plan commenced. Rates are regularly adjusted for inflation in accordance with the provisions of clause 2.14 of this Plan. Applicants should inquire at the Council for information on the latest contribution rates.

## 1.3 Calculating a contribution under this Plan

Section 94 contributions for public car parking infrastructure apply only to Non Residential Development that is:

- situated on land identified within Figures 1-1, 1-2 or 1-3 on the following pages; and
- which is assessed to be deficient in on-site car parking, as calculated under the DCP, or by a car parking assessment of the development prepared to Council's satisfaction.

The total contribution in any particular case is the number of deficient spaces within a development multiplied by the contribution rate for the relevant centre shown in Table 1-1.

Where a development triggers the partial contribution of a car parking space the contribution rate would be multiplied by the parking requirement to calculate the applicable contribution for the development (e.g. a development that is deficient 1.25 car parking spaces would be subject to a contribution amount that is 1.25 times the rate shown in Table 1-1).

The formula for calculating the contribution rate is shown in clause 3.4 of this Plan.

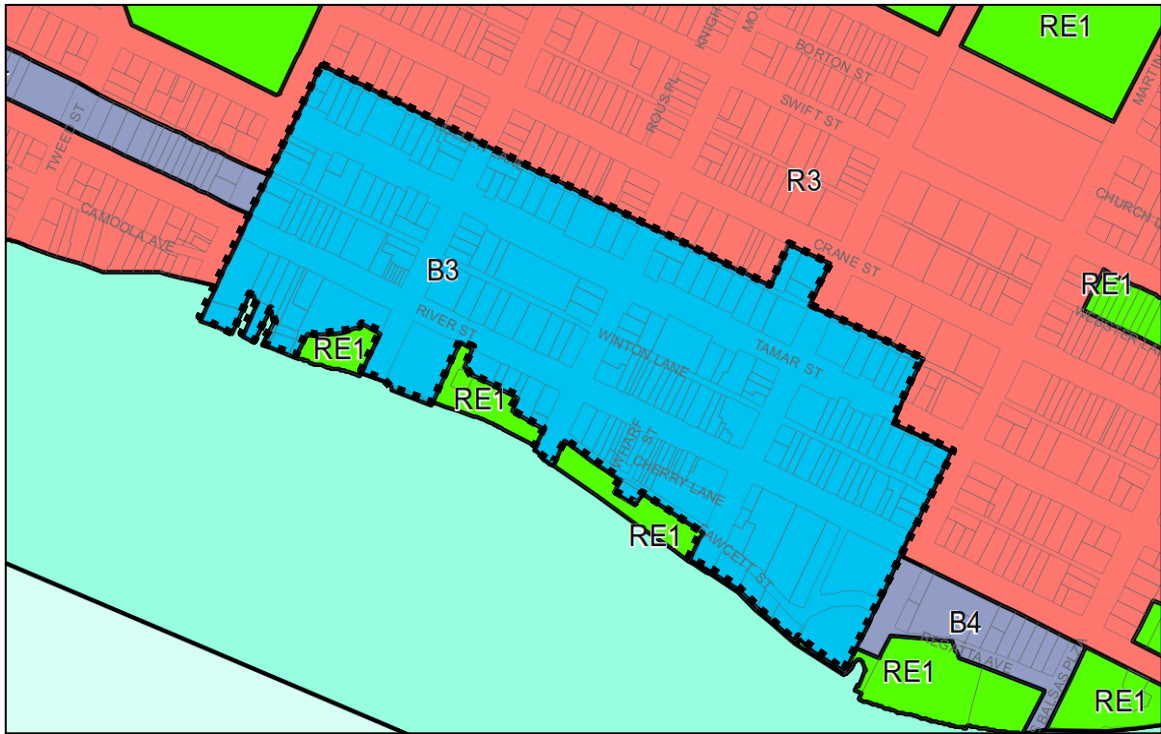


Figure 1-1 Ballina CBD contribution catchment area (shown dashed)

Note: RE1 parcels of land excluded from catchment area.

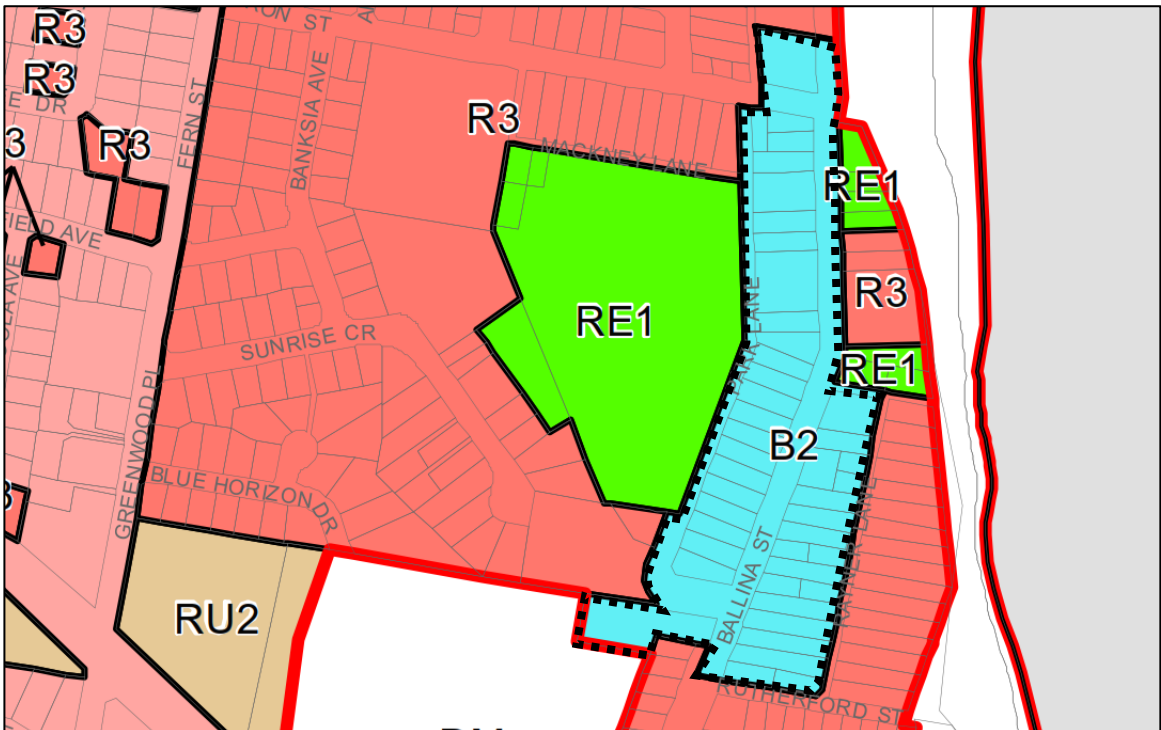
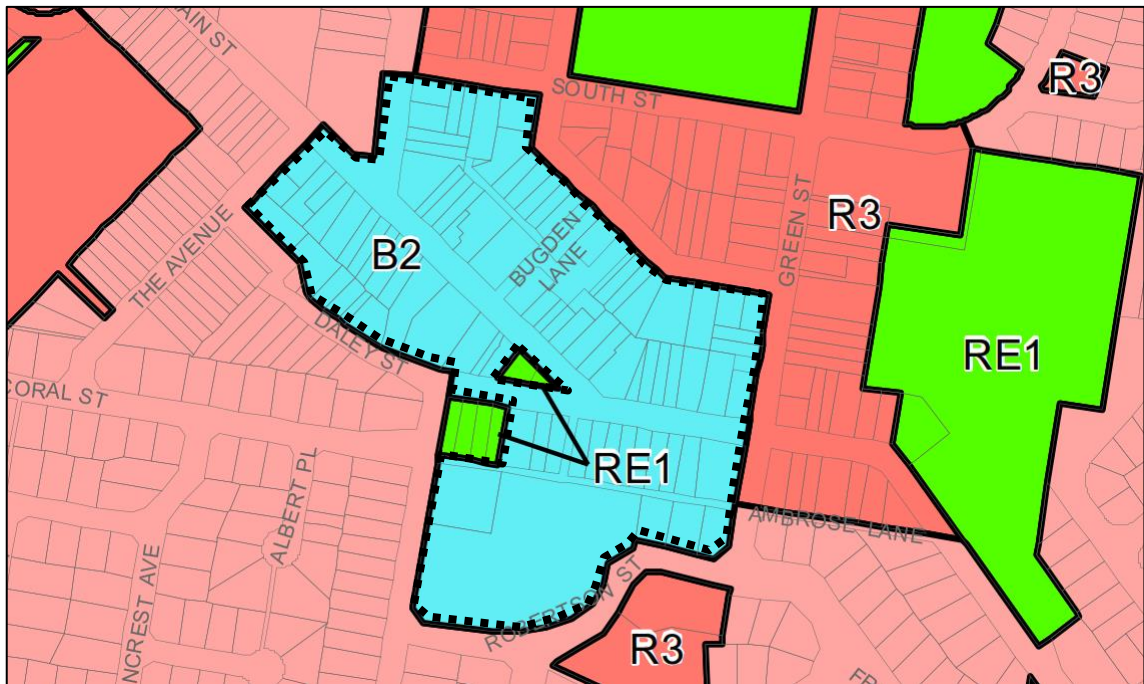


Figure 1-2 Lennox Head Village Centre contribution catchment area (shown dashed)





**Figure 1-3** Alstonville Village Centre contribution catchment area (shown dashed)

Note: RE1 parcels of land excluded from catchment area.

## 2.0 Administration and operation of this Plan

### 2.1 Definitions

In this Plan, the following words and phrases have the following meanings:

**Accredited Certifier** has the same meaning as in the EP&A Act.

**Attributable cost** means the estimate cost for each item in the works schedules included in Part 3 of this Plan, which may differ from the final actual cost of the item. It will be the value used in determining the amount of any offset of monetary contributions as a result of any works in-kind proposal.

**Complying Development** has the same meaning as in the EP&A Act.

**Complying Development Certificate** has the same meaning as in the EP&A Act.

**Consent Authority** has the same meaning as in the EP&A Act but also includes an Accredited Certifier responsible for issuing a Complying Development Certificate.

**Consumer Price Index** means the *Consumer Price Index (All Groups Index) for Sydney* as published by the Australian Statistician.

**Council** means Ballina Shire Council.

**DCP** means the *Ballina Shire Combined Development Control Plan; Chapter 1 – Urban Land; Policy Statement No.2 Car Parking and Access*, or otherwise the prevailing Council development control plan relating to the car parking requirements of developments in the Ballina LGA. **Development Application** has the same meaning as in the EP&A Act.

**Development Consent** has the same meaning as in the EP&A Act.

**EP&A Act** means the *Environmental Planning and Assessment Act 1979*.

**EP&A Regulation** means the *Environmental Planning and Assessment Regulation 2000*.

**GFA** means 'gross floor area' as defined in *Ballina Local Environmental Plan 2012*.

**LGA** means local government area.

**Local Infrastructure** means public amenities and public services that are traditionally the responsibility of local government, excluding water supply or sewerage services.

**Local Infrastructure Contribution** includes a contribution imposed on a Development Consent by a Consent Authority under section 94 of the EP&A Act.

**Minister** means the Minister for Planning.

**Non Residential Development** means any development other than 'residential accommodation' in *Ballina Local Environmental Plan (BLEP) 2012*.

**Planning Agreement** means a voluntary planning agreement referred to in section 93F of the EP&A Act.

**Shire** means the Shire of Ballina.

**Work in kind** means the undertaking of a work or provision of a facility by an applicant which is already nominated in the works schedule of a contributions plan.

**Works schedule** means the schedule of the specific public facilities for which contributions may be required, and the likely timing of provision of those public facilities based on projected rates of development, the collection of development contributions and the availability of funds from supplementary sources, as set out in Part 5 of this Plan.

## 2.2 Name of Plan

This Contributions Plan is called the *Ballina Shire Car Parking Contributions Plan 2014*.

## 2.3 Purposes of Plan

The primary purpose of the Plan is to authorise:

- the Council, when granting consent to an application to carry out development to which this Plan applies; or
- an Accredited Certifier, when issuing a Complying Development Certificate for development to which this Plan applies,

to require a section 94 contribution to be made towards:

- the provision, extension or augmentation of car parking infrastructure only where development is likely to require the provision of or increase the demand for that infrastructure; and
- the recoupment of the previous costs incurred by Council in providing existing car parking infrastructure, within the area to which this Plan applies.

Other purposes of the Plan are:

- to provide the framework for the efficient and equitable determination, collection and management of development contributions toward the provision of public car parking infrastructure generated by development in Ballina's centres; and
- to ensure that the existing community is not unreasonably burdened by the provision of public car parking infrastructure that is required as a result of development in Ballina's centres; and;
- to enable the Council to be both publicly and financially accountable in its assessment and administration of the Plan; and
- to ensure Council's management of development contributions complies with relevant legislation and practice notes.

## 2.4 Local Infrastructure addressed by this Plan

The type of Local Infrastructure that is covered by this Plan is public car parking facilities to meet Non Residential Development in the Ballina CBD, Lennox Head Village Centre, and the Alstonville Village Centre.

## 2.5 Commencement of Plan

This Plan commences on the date on which public notice was given under clause 31(2) of the EP&A Regulation or the date specified in that notice if it is a different date.

This Plan applies to all Development Applications received and applications for Complying Development Certificates made on or after that date. Applications received, made or determined prior to that date will be assessed against the contributions plan or plans in force at the time.

## 2.6 Land to which this Plan applies

This Plan applies to the land identified in Figures 1-1, 1-2 and 1-3.

## 2.7 Development to which this Plan applies

Except as provided for by clause 2.8, this Plan applies to Non Residential Development.

## 2.8 Development exempted from contributions under this Plan

The following developments or components of developments are exempted from the requirement to make a contribution under this Plan:

- Residential Accommodation Development.
- Development that does not involve any increase in GFA on the development site.
- Development for drainage, utility, open space or community facilities purposes to be provided by State Government or the Council.
- Development exempted from contributions by a direction of the Minister pursuant to section 94E of the EP&A Act, current at the time of assessment of the Development Application (The direction will provide the terms of its applicability). Copies of current Directions are available to download from the Department of Planning and Infrastructure (**DPI**) website.

## 2.9 Relationship to other contributions plans

This Plan repeals *Ballina CBD Car Parking Contributions Plan 2004* and *Lennox Head Village Centre Car Parking Contribution Plan 2004*.

These plans however shall continue to apply in respect to those development consents requiring the payment of contributions under those plans.

Funds collected but not yet expended - or monetary contributions yet to be paid – under these plans will be applied towards the provision of car parking facilities in the centre in which the money was collected.

Nothing in this Plan affects the operation and application of any other contributions plans that apply to land in the Shire of Ballina.

Clause 2.24 of this Plan contains a transitional provision consequent upon the making of this Plan.

## **2.10 Contributions may be required as a condition of consent**

This Plan authorises Council or an Accredited Certifier, when determining a Development Application or a notice for a Complying Development Certificate relating to development to which this Plan applies, and subject to other provisions of this Plan, to impose a condition requiring a section 94 monetary contribution from that development to:

- enable the provision of future public car parking infrastructure; and / or
- be applied towards recouping the cost of the provision of existing car parking infrastructure that has been provided by the Council for or to facilitate the carrying out of development and which the development will benefit from.

Accredited Certifiers should also refer to clause 2.13 of this Plan as to their obligations in assessing and determining applications subject to section 94 contributions authorised by this Plan.

## **2.11 Dedication of land free of cost may be required as a condition of consent**

This Plan authorises the Consent Authority, other than an Accredited Certifier, when granting consent to an application to carry out development to which this Plan applies, to impose a condition under section 94(1) of the EP&A Act requiring the dedication of land free of cost to Council towards the provision, extension or augmentation of public car parking infrastructure as specified in the works schedule to meet the demands of the development, or the recoupment of the cost of public car parking infrastructure previously provided within the area.

Wherever land required under this Plan for public car parking infrastructure is situated within a development site, the Consent Authority will generally require the developer of that land to dedicate the land required under this Plan free of cost.

The value of this land will be taken into account in determining the total development contributions required by the development under this Plan. The value of the land to be dedicated free of cost will be the market value of the land determined in accordance with the *Land Acquisition (Just Terms) Compensation Act 1991*.

## **2.12 Other contributions to be taken into account**

The purpose of this clause is to describe Council's policy in implementing section 94(6) of the EP&A Act.

Council, in proposing to impose a requirement for a contribution under this Plan, will take into consideration any land, money or other material public benefit that the applicant has elsewhere dedicated or provided free of cost within the area (or any adjoining area) or previously paid to the Consent Authority, other than:

- a benefit provided as a condition of the grant of development consent under the EP&A Act, or
- a benefit excluded from consideration by a Planning Agreement.

In order for Council to consider the previous benefits made by the applicant, details must be submitted at the time of the Development Application.

A reduction in the contribution requirement under this Plan may be considered where it can be demonstrated by the applicant that:

- the benefit was not required to be provided under a condition of consent or under a Planning Agreement entered into with Council; and
- the consequent reduction in contribution would not adversely affect the Plan's cash flow or prejudice the continued implementation of the works schedule included in this Plan; and
- the land, money or other material public benefit previously provided either continues to provide an ongoing benefit to the community, or offsets some of the need for Local Infrastructure identified in this Plan.

## 2.13 Obligations of Accredited Certifiers

### 2.13.1 Complying Development Certificates

This Plan requires that, in relation to an application made to an Accredited Certifier for a Complying Development Certificate:

- the accredited certifier must, if a Complying Development Certificate is issued, impose a condition requiring a monetary contribution, if such a contribution is authorised by this Plan;
- the amount of the monetary contribution that the Accredited Certifier must so impose is the amount determined in accordance with this clause; and
- the terms of the condition be in accordance with this clause.

#### Procedure for determining the amount of the section 94 monetary contribution

1. If, and only if specified in writing in the application for a Complying Development Certificate, the applicant has requested a credit under section 94(6) of the EP&A Act or an exemption for part or the whole of the development under clause 2.8 of this Plan, the Accredited Certifier must:
  - (a) make a request in writing to the Council for the Council's advice on whether the request is granted, or the extent to which it is granted; and
  - (b) in calculating the monetary contribution, comply with the Council's written advice or if no such advice has been received prior to the granting of the Complying Development Certificate, refuse the applicant's request.
2. Determine the unadjusted contributions in accordance with the formulas in Part 4 of this Plan taking into account any exempt development specified in clause 2.8 and any advice issued by the Council under paragraph 1(b) above.
3. Adjust the calculated contribution in accordance with clause 2.14 to reflect the indexed cost of the provision of infrastructure.

4. Subtract any credit advised by the Council under paragraph 1(b).

### **Terms of a section 94 condition**

The terms of the condition required by this clause are as follows:

#### **Contribution**

*The developer must make a monetary contribution to Ballina Shire Council in the amount of \$ [insert amount] for the purposes of the Ballina Shire Car Parking Contributions Plan 2014.*

#### **Indexation**

*The monetary contribution must be indexed between the date of this certificate and the date of payment in accordance with the following formula:*

$$\frac{\$C_C \times CPI_P}{CPI_C}$$

*Where:*

*\$\$C\_C is the contribution amount shown in this certificate expressed in dollars.*

*CPI\_P is the Consumer Price Index (All Groups Index) for Sydney as published by the Australian Statistician at the time of the payment of the contribution.*

*CPI\_C is the Consumer Price Index (All Groups Index) for Sydney as published by the Australian Statistician which applied at the time of the issue of this certificate.*

*Note: The contribution payable will not be less than the contribution specified in this certificate.*

#### **Time for payment**

*Deferred payments of contributions will not be accepted.*

*For development involving subdivision – the contribution must be paid prior to the release of the subdivision certificate (linen plan), strata plan or a strata plan of subdivision within the meaning of the Strata Schemes (Freehold Development) Act 1973 or the Strata Schemes (Leasehold Development) Act 1986.*

*For development not involving subdivision, but where a Construction Certificate is required, the contribution must be paid prior to the release of the Construction Certificate.*

*For other development, the contribution must be paid prior to the commencement of the use or occupation of premises.*

#### **Works in kind agreement**

*This condition does not need to be complied with to the extent specified in a works in kind agreement between the developer and the Council as allowed by Ballina Shire Car Parking Contributions Plan 2014.*

### 2.13.2 Construction Certificates

It is the responsibility of an Accredited Certifier issuing a Construction Certificate for building work or subdivision work to ensure that each condition requiring the payment of a monetary contribution before work is carried out has been complied with in accordance with the Complying Development Certificate.

The Accredited Certifier must ensure that the applicant provides a receipt (or receipts) confirming that contributions have been fully paid and copies of such receipts must be included with copies of the certified plans provided to the Council in accordance with clause 142(2) of the EP&A Regulation. Failure to follow this procedure may render such a certificate invalid and expose the certifier to legal action.

The only exceptions to the requirement are where a work in kind, material public benefit, dedication of land and/or deferred payment arrangement has been agreed by the consent authority. In such cases the Council will issue a letter confirming that an alternative payment method has been agreed with the applicant.

### 2.14 Indexation of contribution rates

The purpose of this clause is to ensure that the monetary contribution rates imposed at the time of development consent are adjusted to reflect the indexed cost of the provision of infrastructure included in this Plan.

In accordance with clause 32(3)(b) of the EP&A Regulation, Council may, without the necessity of preparing a new or amending contributions plan, make changes to the section 94 contribution rates set out in this Plan to reflect quarterly or annual variations to the *Consumer Price Index (All Groups Index) for Sydney* as provided by the Australian Bureau of Statistics.

The contribution rates will be indexed as follows:

$$\frac{\$C_A \times \text{Current CPI}}{\text{Base CPI}}$$

Where:

**\$C<sub>A</sub>** is the contribution rate for works schedule items at the time of adoption of the Plan expressed in dollars;

**Current CPI** is the *Consumer Price Index (All Groups Index) for Sydney* as published by the Australian Statistician at the time of the review of the contribution rate; and

**Base CPI** is the *Consumer Price Index (All Groups Index) for Sydney* as published by the Australian Statistician at the date of adoption of this Plan.

Note: The contribution rate will not be less than the contribution rate specified at the date of the adoption of this Plan.



## 2.15 Indexation of contributions required by a condition imposed under this Plan

The purpose of this clause is to ensure that the monetary contributions imposed on developments at the time of consent are adjusted at the time of payment to reflect the indexed cost of the provision of infrastructure included in this Plan.

A contribution required by a condition of Development Consent imposed in accordance with this Plan will be indexed between the date of the grant of the consent and the date on which the contribution is made as follows.

The total contribution for all works schedule items at the time of payment is determined by the following formula:

$$\frac{\$C_C \times CPI_P}{CPI_C}$$

Where:

**\$C<sub>C</sub>** is the contribution amount shown in this certificate expressed in dollars;

**CPI<sub>P</sub>** is the *Consumer Price Index (All Groups Index) for Sydney* as published by the Australian Statistician at the time of the payment of the contribution; and

**CPI<sub>C</sub>** is the *Consumer Price Index (All Groups Index) for Sydney* as published by the Australian Statistician which applied at the time of the issue of the Development Consent.

Note: The contribution payable will not be less than the contribution specified in this certificate.

## 2.16 Timing of payment of contributions

A contribution must be paid to the Council at the time specified in the condition that imposes the contribution.

Council's requirements in relation to the timing of payments of monetary contributions required under this Plan are as follows:

- For development involving subdivision – the contribution must be paid prior to the release of the subdivision certificate (linen plan), strata plan or a strata plan of subdivision within the meaning of the *Strata Schemes (Freehold Development) Act 1973* or the *Strata Schemes (Leasehold Development) Act 1986*;
- For development not involving subdivision, but where a Construction Certificate is required, the contribution must be paid prior to the release of the Construction Certificate; and
- For other development, the contribution must be paid prior to the commencement of the use or occupation of premises.

## 2.17 Policy on deferred or periodic payments

The Council will generally not accept deferred or periodic payment of contributions. However, Council may consider an application under section 96 of the EP&A Act to modify the condition to provide for the deferred or periodic payment of the contribution where:

- compliance with the provisions relating to when contributions are payable is unreasonable or unnecessary in the circumstances of the case;
- deferred or periodic payment will not prejudice the timing or the manner of the provision of the services or facilities for which the contribution is required as outlined in the works program;
- where the applicant intends to make a contribution by way of a Planning Agreement, works in kind or land dedication in lieu of a cash contribution and Council and the applicant have a legally binding agreement for the provision of the works or land dedication; and
- there are circumstances justifying the deferred or periodic payment of the contribution.

The decision to accept a deferred or periodic payment is at the sole discretion of the Council.

In the event Council decides to accept the deferred or periodic payment of contributions, the applicant may be required to provide a bank guarantee by an Australian bank or recognised financial institution for the full amount of the contribution or outstanding balance on condition that:

- the bank's guarantee by a bank for the amount of the total contribution, or the amount of the outstanding contribution, plus an amount equal to thirteen (13) months interest plus any charges associated with establishing or operating the bank security;
- the bank unconditionally pay the guaranteed sum to the Council if the Council so demands in writing not earlier than 12 months from the provision of the guarantee or completion of the works;
- the bank must pay the guaranteed sum without reference to the applicant or landowner or other person who provided the guarantee, and without regard to any dispute, controversy, issue or other matter relating to the development consent or the carrying out of development;
- the bank's obligations are discharged when payment to the Council is made in accordance with this guarantee or when Council notifies the bank in writing that the guarantee is no longer required; and
- where a bank guarantee has been deposited with Council, the guarantee shall not be cancelled until such time as the original contribution and accrued interest are paid in accordance to the 90 day bank bill rate.

## 2.18 Reassessment of contributions

Council may consider an application for the reassessment of section 94 contribution imposed under this Plan. This may result in the contribution being reduced or waived or modified.

Where a condition of Development Consent has already been imposed requiring the payment of a contribution, the applicant will need to lodge an application to review the consent in accordance with section 82A of the EP&A Act.

The request shall be in writing and provide sufficient information to satisfy Council of the inappropriate nature of the contribution and the implications to Council of reducing or waiving the contribution in the particular circumstances.

The instances in which Council may consider a reassessment may include the following:

- The applicant is a registered charity, church, hospital or community organisation;
- The development satisfies a broader planning objective and the achievement of which is considered by Council to be of greater importance or priority than making a contribution;
- Where it is considered that the contribution is unreasonable; or
- The application involves the development of a heritage item.

## **2.19 Works in kind and other material public benefits**

This clause applies to development, or proposed development, on land subject to a section 94 contribution under this Plan. A person may make an offer to the Council to carry out works or provide another kind of material public benefit or dedicate land, in lieu of making a section 94 contribution in accordance with a condition imposed under this Plan, in the terms described below.

The Council may accept an offer by the applicant to make a contribution by way of works in kind (defined as an item in the works schedule to this Plan), or material public benefit (defined as anything that is not included in the works schedule to this Plan) or the dedication of land as referred to in the EP&A Regulation.

The decision will be at the discretion of Council.

### **2.19.1 Matters for Council's consideration**

Factors that Council will take into consideration in making its decision will include the following:

- The value of the works and/or dedication of land is at least equal to the value of the contribution that would otherwise be required under this Plan.
- The standard and timing of delivery of, and security arrangements applying to, the works the subject of the offer are to Council's satisfaction.
- Whether the acceptance of the works and/or dedication of land will prejudice the timing or the manner of the provision of public facilities included in the works program of this Plan.
- The extent to which works and/or dedication of land satisfies a demonstrated community need.
- The extent to which the works and/or dedication of land satisfies the purpose for which the contribution was sought.
- The conditions applying to the transfer of the asset to the Council are to Council's satisfaction.
- The financial implications for cash flow and the continued implementation of the works schedule included in this Plan (including whether Council would need to make up for any shortfall in contributions by its acceptance of the offer).
- The overall benefit of the proposal.

### 2.19.2 Agreements

Council will require the applicant to enter into a written agreement for the provision of the works prior to the commencement of works or the development.

Works in kind and material public benefit agreements shall be made between the Council and the developer and (if the developer is not the land owner) the land owner.

Agreements shall specify (as a minimum) the works the subject of the offer, the value of those works, the relationship between those works and this Plan, the program for delivering the works.

Where an offer is made prior to the issue of Development Consent, the offer may be in the form of a Planning Agreement. If the offer is made by way of a draft Planning Agreement under the EP&A Act, Council will require the agreement to be entered into and performed via a condition in the development consent. Planning Agreements shall address the matters included in the EP&A Act and EP&A Regulation.

### 2.19.3 Valuation of offers

The value of works offered as works in kind is the Attributable Cost of the works (or a proportion of the Attributable Cost if the offer involves providing only part of a work) indexed in accordance with the provisions of this Plan.

The Attributable Cost of works will be used in the calculation of the value of any offset of monetary contributions required under this Plan.

The value of any other kind of material public benefit will be determined by a process agreed to between the Council and the person making the offer at the time the Development Application is being prepared.

Credit for material public benefits will not be given over and above the relevant contributions liabilities for any development.

## 2.20 Goods and Services Tax (GST)

At the time this Plan was made, the position of the Australian Taxation Office was that the payment of development contributions made under the EP&A Act is exempt from the Goods and Services Tax (GST).

Items in the works schedule of this Plan have been calculated without any GST component.

## 2.21 Accountability and access to information

Council is required to comply with a range of financial accountability and public access to information requirements in relation to community infrastructure contributions. These are addressed in Divisions 5 and 6 of Part 4 of the EP&A Regulation and include:

- maintenance of, and public access to, a contributions register;
- maintenance of, and public access to, accounting records for contributions receipts and expenditure;
- annual financial reporting of contributions; and

- public access to contributions plans and supporting documents.

The register is available for inspection by any person at Council's offices free of charge at any time during normal office hours.

## **2.22 Review of Plan without the need for public exhibition**

This Plan with supporting information will be subject to regular review by Council, so as to:

- monitor development trends and income received by the Plan.
- ensure that contributions rates reflect actual costs incurred by the Plan.
- enable alteration to the works schedule if development rates differ from original expectations.

Pursuant to clause 32(3) of the EP&A Regulation, Council may make certain minor adjustments or amendments to the Plan without prior public exhibition and adoption by Council. Minor adjustments could include minor typographical corrections, amendments to rates resulting from changes in the published indexes adopted by this Plan (see clause 2.14).

## **2.23 Savings and transitional arrangements**

A Development Application which has been submitted prior to the adoption of this Plan but not determined shall be determined in accordance with the provisions of the contributions plan or plans which applied at the date of submission of the application.

## 3.0 Car parking demands and infrastructure programs

This Part describes:

- Council's role in providing parking in centres.
- The expected development that will generate a demand for the public car parking infrastructure included in this Plan.
- The infrastructure program Council proposes to deliver to address development that is parking-deficient, including location, costs and staging details.
- The formulas for calculating reasonable monetary contributions that are authorised by this Plan to be imposed on parking-deficient developments.

### 3.1 Council's role in providing parking in town centres

Parking and access issues are often most significant for developments that generate a higher rate of vehicle trips, particularly Non Residential Developments that include commercial, professional, retail and entertainment type uses. These uses tend to be concentrated in the town and neighbourhood centres of the LGA.

Car parking to meet the needs of town centre developments is provided both as on-street spaces as well as off-street spaces in formalised car parks.

Council plays an active role in maintaining the viability of the town centres through providing an appropriate level of on-street car parking and through providing centralised public car parks.

Accommodating Non Residential Development in town centres and maintaining safe and convenient vehicular access for people using those centres are both important objectives for the Council in its roles as a Consent Authority and as manager of public assets.

### 3.2 Expected Non Residential Development

#### 3.2.1 Overview

The type, extent and location of expected Non Residential Development which is to occur within Ballina CBD, Lennox Head Village Centre and Alstonville Village Centre is difficult to predict and as such assumptions are required to be made. While there are a number of contributing factors such as land availability & costs, economic climate, government policies etc., any increase in Non Residential Development is largely attributed to an increase in population to support this type of development.

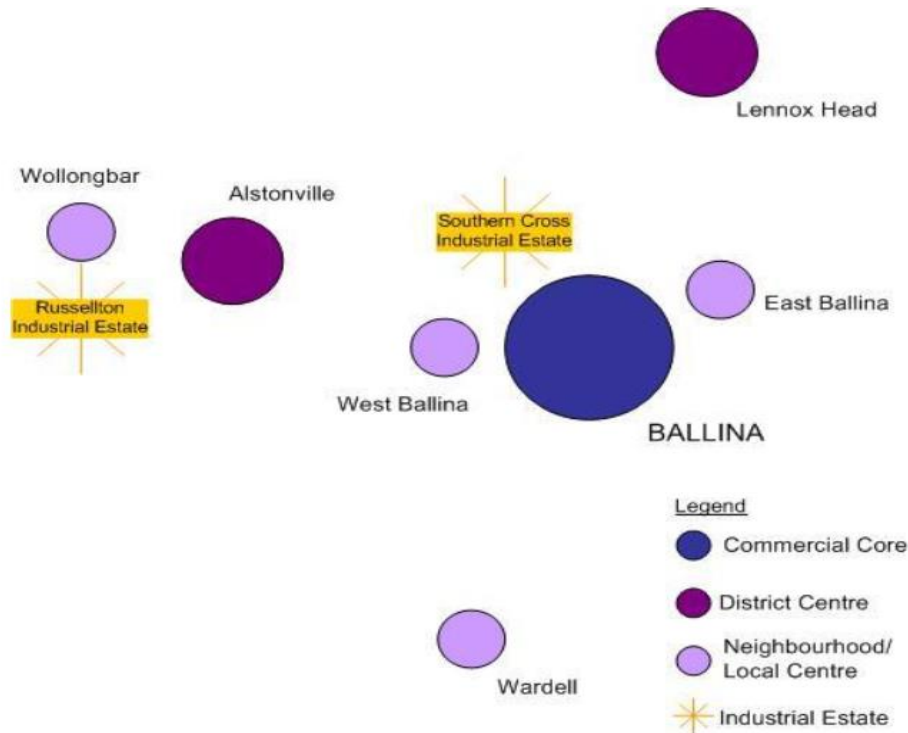
The Far North Coast Regional Strategy (**FNCRS**) 2006-31<sup>1</sup> identifies that the region is anticipated to experience a population increase of approximately 60,400 by 2031 with a significant proportion of that growth being absorbed within Tweed Heads and Ballina. Between 2006 and 2011, the population of Ballina LGA increased by 2.1%<sup>2</sup> with this number anticipated to increase in the future.

---

<sup>1</sup> FNCRS, 2006, p1

<sup>2</sup> Profile .id, Ballina Shire. Population, households and dwellings.

While the FNCRS notes that Lismore and Tweed Heads are the two major regional cities, Ballina is identified as an emerging major centre within the region<sup>3</sup>. The Ballina LGA has a dwelling target under the FNCRS of providing an additional 8,400 dwellings by 2031<sup>4</sup>. The key business centres in Ballina LGA which will support this growth include Ballina CBD, Lennox Head and Alstonville. The retail hierarchy for the Ballina LGA identifies Ballina CBD as the dominant commercial core area with Lennox Head and Alstonville both being considered within the next tier and classified as District Centres (**Figure 3-1**).



Source: Ballina Shire Council Growth Management Strategy 2012, p11

**Figure 3-1 Ballina LGA Commercial Hierarchy**

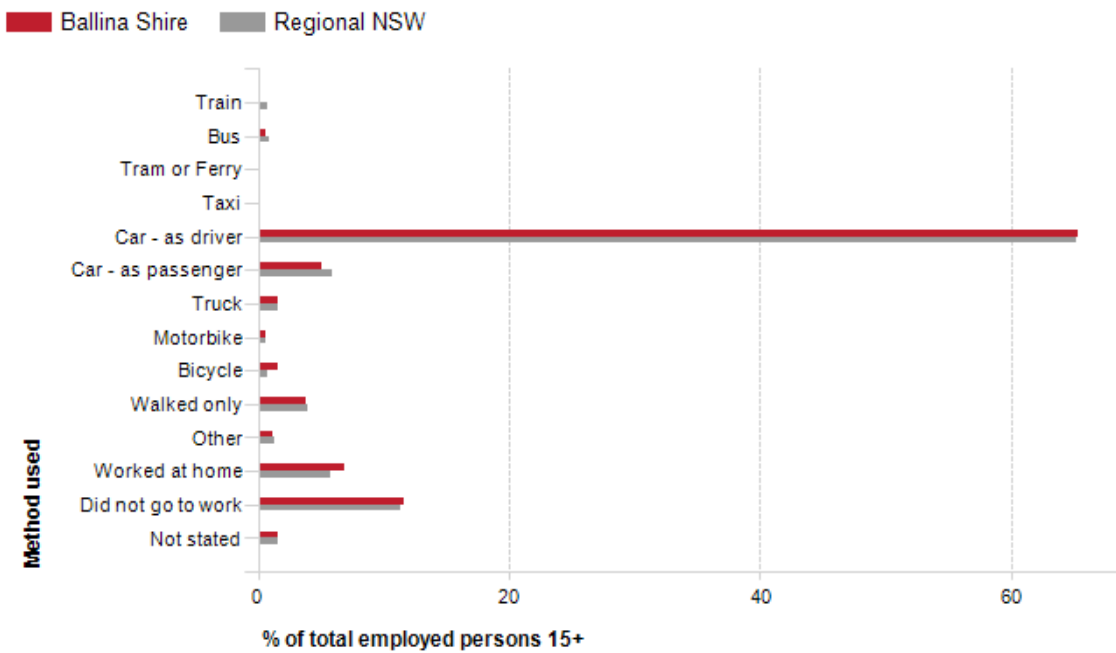
Employment growth within the Ballina Shire LGA is expected to grow by 4,400 persons by 2028 particularly within the areas of property, business services industry, retail trade, tourism related trades construction, health & community services and education<sup>5</sup>. This future growth is anticipated to place a growing demand on the supply of commercial land which in turn is likely to impact on the demand for parking particularly within larger centres where land may be at shorter supply.

The nexus between car parking and employment uses is highlighted within the 2011 Census results. These results identify that within the Ballina Shire LGA, 72.7% of residents used a private vehicle as their main method of travelling to work demonstrating the need for car parking within the CBD and district centres to support employment growth. This included being the driver of a car (65.4%), being a passenger within a car (5.1%), driving a truck (1.6%) and driving a motorbike (0.6%) (**Figure 3-2**).

<sup>3</sup> FNCRS, 2006, p 4

<sup>4</sup> Ibid., p27

<sup>5</sup> Ballina Shire Council Growth Management Strategy 2012, p11



Source: .id the population experts based on data from the Australian Bureau of Statistics, Census of Population and Housing, 2011

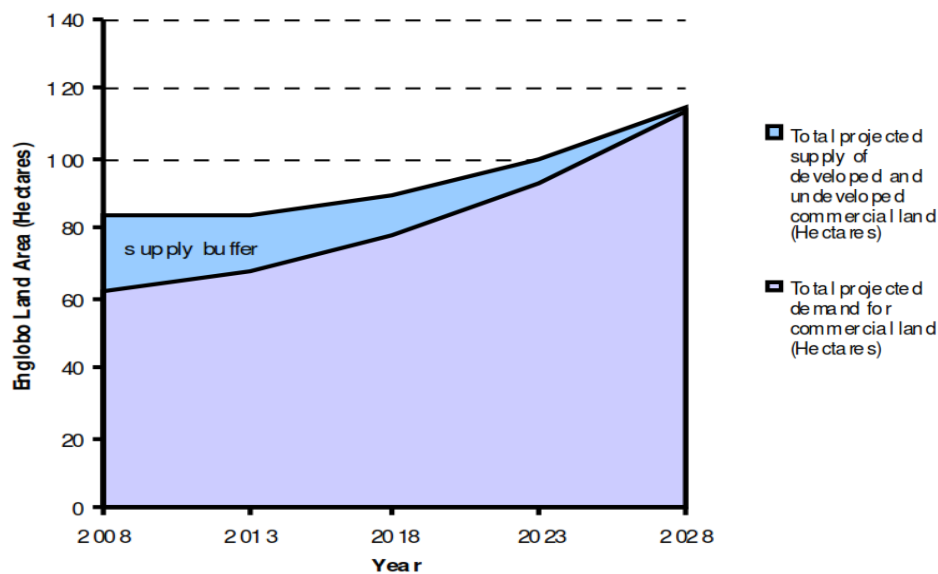
**Figure 3-2 Method of travelling to work - Ballina Shire LGA (2011)**

Of the 13,744 total workers within the Ballina Shire LGA, 76% were residents within the local area while 24% commuted to Ballina from outside of the LGA. It could reasonably be assumed that most workers residing outside of the LGA would rely on either a private vehicle to drive to work or would be the passenger in a private vehicle again demonstrating the nexus between car parking and employment uses within the CBD and district centres of Ballina.

Looking at supply and demand of commercial zoned land within the Ballina LGA, the amount of available commercial land is anticipated to drop to less than 1% by 2028<sup>6</sup> (Figure 3-3). This typically means that as supply decreases, there is anticipated to be a greater reliance on the provision for off-site parking in order to maximise the commercial zoned land.

<sup>6</sup> Ballina Shire Council Growth Management Strategy, July 2012.





Source: Ballina Shire Council Growth Management Strategy (2012)

**Figure 3-3 Commercial Land Audit Projections of Demand and Land Supply Buffer**

In order for the Council to be able to meet the Non Residential Development demands relating to public car parking infrastructure in the identified centres, this Plan authorises the imposition of nexus-based section 94 contributions where the relationship between expected development and the required public car parking is able to be clearly articulated.

### 3.2.2 Ballina CBD

As the major business and retail centre within the region, Ballina supports the population of the Ballina LGA which is comprised of 39,274 people<sup>7</sup>. The commercial core area of Ballina is split into two areas including the CBD (River Street/Tamar Street) and the Kerr Street Precinct to the north of the CBD. The Ballina Commercial Centre provides for a higher order of commercial services and facilities in comparison to other areas within the LGA. This includes the provision of large discount department stores and supermarkets along with a variety of retail, civic and professional services and facilities.

### 3.2.3 Lennox Head Village Centre

The Ballina Shire Council Growth Management Strategy 2012 identifies that within Lennox Head, the provision of services and facilities has grown significantly within recent years. In 2011, the population of Lennox Head was 6,147 people living within 2,731 private dwellings<sup>8</sup>. The district centre of Lennox Head is the second largest within the LGA behind Ballina and includes a mix of commercial facilities, retail and professional services. While there are a number of two storey buildings along the main shopping strip (Ballina Street), the majority of shop fronts within Lennox Head are situated at ground level.

<sup>7</sup> Australian Bureau of Statistics, 2011 Census (Code: LGA 10250)

<sup>8</sup> Australian Bureau of Statistics, 2011 Census (Code: SSC 11353)

### 3.2.4 Alstonville Village Centre

The primary retailing area within Alstonville is the shopping plaza and retail and professional services situated along Main Street. The area is characterised by predominantly single storey shop fronts with the shopping plaza situated at the southern end of Main Street. This district centre supports a local population of approximately 5,648 people living within 2,539 private dwellings<sup>9</sup>.

## 3.3 Nexus

A Consent Authority may impose a section 94 contribution for Local Infrastructure on development only if that contribution fairly and reasonably relates to that development. This means that the contribution amount must accurately reflect the relationship between the development and the infrastructure the subject of the contribution.

This relationship between the expected types of development in the area and the demand for additional public facilities to meet demand for infrastructure is also called 'nexus'.

Nexus is often discussed in terms of causal, physical and temporal nexus.

### 3.3.1 Causal nexus

Causal nexus requires that the need for the service or facility being levied must be as a result of the development which is to be levied.

The Council's development controls establish the required number of car parking spaces to be provided to meet the demands of development. Parking for Non Residential Development in centres is to be provided for employees and visitors associated with the development. However, it is not always possible or desirable for developments to accommodate all the required on-site parking within a development. In these circumstances, it is reasonable for Council to impose a car parking contribution on that development corresponding to the number of deficient car parking spaces; and for that monetary contribution to be applied toward the provision of alternate public parking facilities in the general vicinity of the development.

Vehicle trips to centres are often for multiple purposes. Substantial efficiencies in parking provision can therefore be gained by having a shared public car parking in consolidated locations around a town centre.

### 3.3.2 Spatial nexus

Spatial nexus requires that the facility or service be located so as to serve the needs of those who created the demand for it.

Contributions collected from development within each town centre forming part of this Plan (i.e. Ballina CBD, Lennox Head Village Centre and Alstonville Village Centre) will be used to fund the provision of public car parking within the town centre in which the contribution was collected for.

Details on the location of the public car parking infrastructure to be provided in accordance with this Plan have been identified within clauses 3.6.2 to 3.6.4.

<sup>9</sup> Australian Bureau of Statistics, 2011 Census (Code: SSC 10032)

### 3.3.3 Temporal nexus

Temporal nexus requires that the service or facility be provided in a timely manner to benefit those who have contributed towards it.

Council will seek to construct the car parking facilities according to the rate of parking-deficient Non Residential Development that generates the need for infrastructure within each of the town centres. Some of the infrastructure has already been provided. Funds collected under this Plan will be prioritised toward recouping these outlays. As the delivery of future facilities under this Plan is largely dependent on the rate of development and subsequent payment of car parking contributions, it is difficult to anticipate the timing of when this infrastructure will be delivered. As such, Council is committed to fund projects once the demand for these facilities is established and subsequent funds are received.

Details on the demand for Local Infrastructure, how the infrastructure costs were determined and the strategies for the delivery of the Local Infrastructure are included in Part 4 of this Plan.

### 3.4 Contribution rate formula

The car parking contribution rate is calculated by dividing the cost of providing the facilities by the number of proposed additional number of car spaces to be provided in the relevant centre.

The contribution rate payable is calculated using the following formula:

$$\text{Contribution Rate per deficient on-site car parking space (\$)} = \frac{\$Land + \$Works}{S}$$

Where:

$\$Land$  = the cost of the acquisition of land for public car parking spaces (whether already purchased<sup>10</sup>, or yet to be purchased) in the relevant centre as identified in clause 3.6.2 to 3.6.4 of this Plan.

$\$Works$  = the cost of the public car parking works (whether already undertaken<sup>11</sup> or yet to be undertaken) in the relevant centre as identified in clause 3.6.2 to 3.6.4 of this Plan.

$S$  = the total number of public car spaces proposed to be provided under this Plan in the relevant centre in which the development is proposed.

<sup>10</sup> The land costs to be recouped are the cost to Council of land purchases, indexed in accordance with clause 25l of the EP&A Regulation to the time this Plan was prepared

<sup>11</sup> The works costs to be recouped are the cost to Council of the works, indexed in accordance with clause 25l of the EP&A Regulation to the time this Plan was prepared

### 3.5 Infrastructure costs

The costs and indicative timing of car parking facilities for each town centre subject to this Plan are included in clauses 3.6.2 to 3.6.4 of this Plan.

For parking facilities yet to be provided, Council will prepare design concepts for the facilities so that specification and costing of the facilities can be more accurately defined as implementation of this Plan proceeds. This may result in amendment of this Plan.

Costs for the future car parking facility works included in this Plan were prepared by Council staff drawing on their experience in planning and delivery of similar infrastructure in the area.

The costs of future works include reasonable allowances for anticipated on-costs associated with survey, design, legal and project management associated with each infrastructure item.

The costs of land already acquired, and the costs of works already completed in advance of development, are the completed costs to Council.

### 3.6 Car parking infrastructure strategies

#### 3.6.1 How will the car parking facilities be delivered?

Council and Accredited Certifiers will require section 94 contributions for any Non Residential Development which is deficient in parking and located on land identified in Figures 1-1, 1-2 and 1-3 of this Plan.

The contributions will generally be in the form of monetary contributions, although where the Consent Authority requires a contribution and that Consent Authority is the Council, contributions of land may be required instead of or in addition to monetary contributions.

Developers may choose to provide, subject to the agreement of the Council, car parking infrastructure identified in this Plan as works in kind or provide another type of material public benefit as means of satisfying a section 94 contribution requirement. If the contribution is to be satisfied in this manner, the developer must comply with the other relevant provisions of this Plan, particularly clause 2.19.

The car parking infrastructure schedules included in this Plan are based on strategic information. It is likely that, as the planning process for the different town centres proceeds, modified and more cost-effective solutions that still meet the strategy objectives will be developed.

### 3.6.2 Ballina CBD infrastructure program

*Ballina CBD Car Parking Contributions Plan 2004 (pre-existing Ballina CP)* identified that 75 at-grade car parking spaces had previously been provided within the Wigmore Arcade car park located at 84 Tamar Street, Ballina (**Figure 3-4**). Car parking contributions under the pre-existing Ballina CP were being collected towards the future expansion of this car park to provide for a multi-storey car park and/or the purchase and development of additional land in Tamar Street, Ballina for car parking. The preliminary plans illustrating the proposed multi-deck car park are attached to this Plan at **Appendix A**.

Under this Plan, contributions will continue to be collected towards the construction of the multi-storey car park and/or the purchase and development of additional land in Tamar Street for car parking, along with the development of car parking and ancillary facilities on land already purchased at 74 and 78 Tamar Street under the pre-existing Ballina CP. The additional land to be purchased has not yet been confirmed but is expected to be in close proximity to Council's current landholdings for car parking as per Figures 3-4 and 3-5.

The preliminary plans for the multi-storey car park facility provide for 255 car parking spaces at 84 Tamar Street spaces. This includes 248 spaces, within Level two, three and four and seven disabled spaces directly accessed off Winton Lane. A total of 255 spaces are planned.



Source: Six Viewer, NSW Land and Property Information

**Figure 3-4 Aerial Photo identifying Wigmore Arcade Car Park at 84 Tamar Street, Ballina**

There are two other sites within Ballina CBD identified for future car parking which are shown within **Figure 3-5**. Both of these sites were acquired by Council on 24 October 2012 and funded directly from existing section 94 contributions collected under Ballina CP.



Source: Six Viewer, NSW Land and Property Information

**Figure 3-5 Location of proposed car parks at No.74 and No.78 Tamar Street, Ballina**

Plans of the proposed at-grade car parking facilities at No.74 and No.78 Tamar Street, Ballina are included in **Appendix B and C**.

To assist in the provision of car parking at 74, 78 and 84 Tamar Street, Council as part of the construction of car parking on 74 and 78 Tamar Street will provide ancillary toilet facilities as part of this car park development. These facilities are proposed to be provided for the benefit of users of this car parking complex as per Appendix C of this document.

In addition to 74, 78 and 84 Tamar Street, Council also expects to purchase extra land for car parking in this locality. It is anticipated that any extra land purchased will be approximately 600 square metres in size which is estimated to yield approximately 20 car parking spaces.

A summary of the Ballina CBD car parking infrastructure that will be provided using contributions imposed under this Plan is shown in **Table 3-1**. The location of these facilities is shown on **Figures 3-4 and 3-5** with the extra land to be purchased anticipated to be in the vicinity of this locality.

The costs identified in Table 3-1 include the construction of the car parking infrastructure along with necessary demolition costs in relation to 74 and 78 Tamar Street, Ballina.

**Table 3-1 Ballina CBD car parking infrastructure program**

Property	Description of infrastructure	Number of spaces provided	Demolition and Construction (\$)	Acquisition (\$)	Estimated cost (\$)
Wigmore Car Park 84 Tamar Street, Ballina	Wigmore car park extension Multi-storey car park	255	6,500,000 <sup>(1)</sup>	N/A <sup>(3)</sup>	6,500,000
74 Tamar Street	At-grade parking	40	495,000 <sup>(5)</sup>	N/A <sup>(3)</sup>	495,000
78 Tamar Street	At-grade parking	25	630,000 <sup>(2)(5)</sup>	N/A <sup>(3)</sup>	630,000
Tamar Street	At-grade parking	20	200,000	800,000 <sup>(4)</sup>	1,000,000
<b>TOTAL</b>		<b>340 spaces</b> <sup>(6)</sup>	<b>7,825,000</b>	<b>800,000</b>	<b>8,625,000</b>

Notes:

- (1) Correspondence from Turner and Townsend dated 29 July 2013.  
(2) Estimated construction and demolition costs, along with cost of ancillary amenity facilities.  
(3) Land already in Council ownership.  
(4) Based on market advice and preliminary negotiations with existing property owners.  
(5) Includes the cost of site remediation.  
(6) Total number of spaces based on estimates prepared by Council staff in February 2014.

### 3.6.3 Lennox Head Village Centre infrastructure program

The pre-existing *Lennox Head Village Centre Car Parking Contribution Plan* identified parking to be provided as detailed within the Lennox Head Village Landscape Master Plan. This was to be achieved through the construction of 90 degree parking in Park Lane adjacent to Williams Reserve.

The Park Lane car parking, as illustrated within **Figure 3-6**, was completed in December 2010 to provide a total of 78 car parking spaces. Out of these 78 car parking spaces a total of 21 were required for the construction of the Lennox Head Cultural and Community Centre. In addition, a total of 38 Park Lane car parks were available prior to construction. Based on this calculation the net increase in car parking provided by the re-construction of Park Lane was 19 additional car parking spaces (i.e. 78 less 21 less 38). Contributions will continue to be collected under this Plan to recoup funds where car parking cannot be provided on-site in accordance with this Plan.

To cater for future development Council will also provide 21 car parking spaces on the Council owned land at 3 Byron Street, Lennox Head located along Park Lane between MacKney Lane and Byron Street (**Figure 3-6**). In order to facilitate the provision of these car parks it will be necessary for Council to purchase additional land at a site still to be confirmed to relocate the Rural Fire Services currently located on that site, along with providing a new rural fire shed on that property.

A summary of the Lennox Head Village Centre car parking infrastructure that contributions will be put towards under this Plan is shown within **Table 3-2**. The location of the facilities is shown on **Figures 3-6**.

**Table 3-2 Lennox Head Village Centre car parking infrastructure program**

Property	Description of infrastructure	Number of spaces provided	Demolition and Construction (\$)	Acquisition (\$)	Estimated cost (\$)
Park Lane Lennox Head	On-street parking	19	157,000 <sup>(1)</sup>	N/A <sup>(3)</sup>	157,000
	Less recouped under previous plan	(10.89)	(90,023)	N/A	(90,023)
3 Byron Street	At-grade parking and acquisition of new site to relocate Rural Fire Services and construct new shed.	21	47,000	350,000 <sup>(2)</sup>	397,000
<b>TOTAL</b>		<b>29 spaces</b>	<b>113,977</b>	<b>350,000</b>	<b>463,977</b>

Notes:

(1) Based on total construction cost of \$739,000 with a car parking component of 21.2%, represents a cost for car parking of approximately \$157,000 or \$8,264 per space.

(2) Based on land acquisition cost of \$250,000 plus \$100,000 for the provision of a new rural fire shed.

(3) Land already in Council ownership.





Source: Six Viewer, NSW Land and Property Information

**Figure 3-6 Lennox Head Village Centre car parking infrastructure location**

### **3.6.4 Alstonville Village Centre infrastructure program**

Car parking contributions have not previously been collected for Alstonville Village Centre. Alstonville has an existing at-grade car park within its business centre which is accessed off Commercial Road and Budgen Lane. A total of 80 car parking spaces are currently provided which includes 16 spaces over private land and 64 spaces owned by Council.

The existing car park is proposed to be redesigned and enlarged to provide for a total of 140 car parking spaces at-grade. This includes the existing 16 spaces over private land. The design of the new car park necessitates expanding the existing car park over No.9 Commercial Road and partially over Nos.13 and 15 Commercial Road along with redesigning the internal layout to maximise the number of car parking spaces provided.

Council purchased No. 9 Commercial Road, Alstonville on 18 January 2008 which was forward-funded by Council. Council will recoup the costs of this land through contributions received under this Plan. Parts of Nos. 13 and 15 Commercial Road required for parking are still to be acquired by Council. This Plan levies for the costs of these future acquisitions. The estimated costs of the future acquisitions have been estimated based on the unit cost of land that Council paid for 9 Commercial Road.

The preliminary plan illustrating the proposed car park is attached to this Plan at **Appendix D**. The timing of the provision of this car park will be dependent upon future development and the need for additional car parking within the village centre.

A summary of the Alstonville Village Centre car parking infrastructure that will be provided using contributions imposed under this Plan is shown in **Table 3-3**. The location of the facilities is shown on **Figures 3-7**.

**Table 3-3 Alstonville Village Centre car parking infrastructure program**

Property	Description of infrastructure	Number of spaces provided	Demolition and Construction (\$)	Acquisition (\$)	Estimated cost (\$)
9 Commercial Road	Commercial Rd At-grade car park	140 spaces in the final design across each of the sites combined.	160,000	444,589 <sup>(1)</sup>	604,589
13 Commercial Road and augmentation of main car park area	Commercial Rd At-grade car park		55,000	86,850 <sup>(2)(3)</sup>	141,850
15 Commercial Road	Commercial Rd At-grade car park		55,000	81,900 <sup>(2)(4)</sup>	136,900
<b>TOTAL</b>		<b>60 net additional spaces</b>	<b>270,000</b>	<b>613,339</b>	<b>883,339</b>

Notes:

(1) Land acquisition cost of \$400,000 (January 2008) indexed to Sept 2013 in accordance with clause 25I of the EP&A Regulation. This equates to a square metre rate of \$623 based on an area of 751 square metres.

(2) Assumes an acquisition cost of \$450 per square metre based on a land valuation completed by a valuer in 2013 for Council (land only).

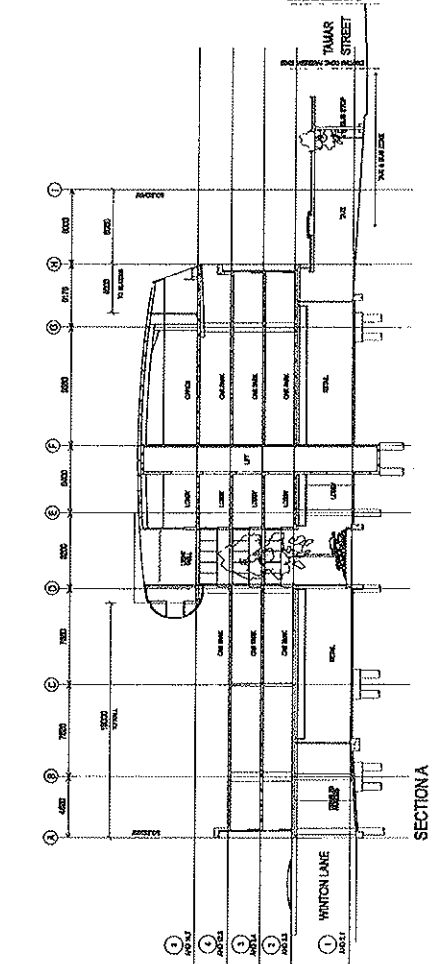
(3) Pro rata amount based on 193 square metres of the site to be used for parking and a rate of \$450 per square metre.

(4) Pro rata amount based on 182 square metres of the site to be used for parking and a rate of \$450 per square metre.

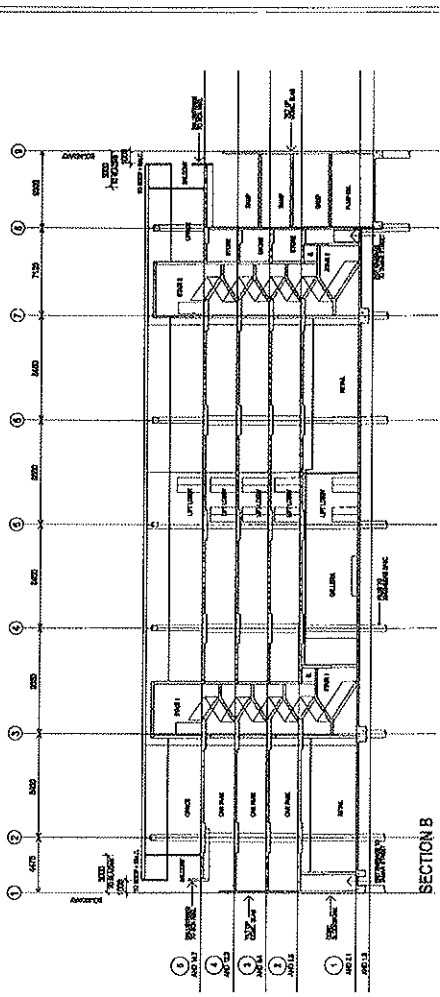


Figure 3-7 Alstonville Village Centre car parking infrastructure location

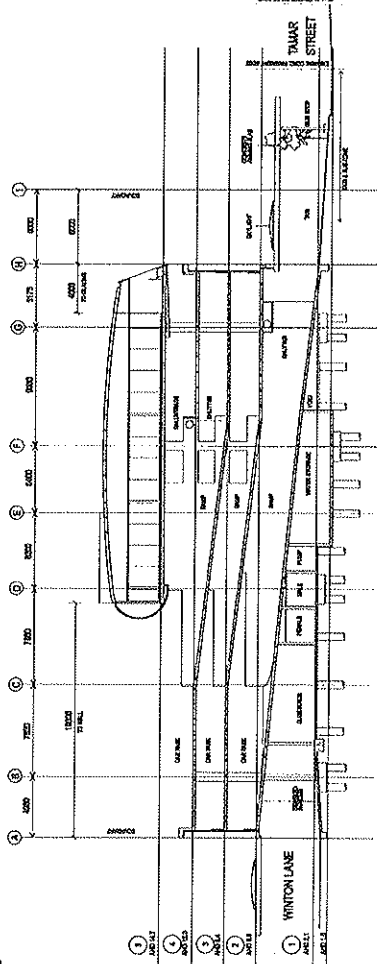
## APPENDIX A



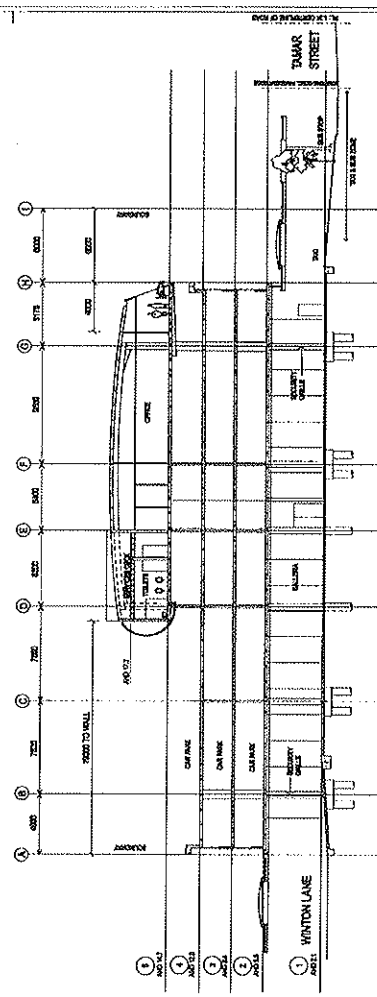
SECTION A



SECTION B



SECTION C



SECTION D



Signatures/Seals/Notes



PROJECT BACKGROUND

PROJECT NUMBER

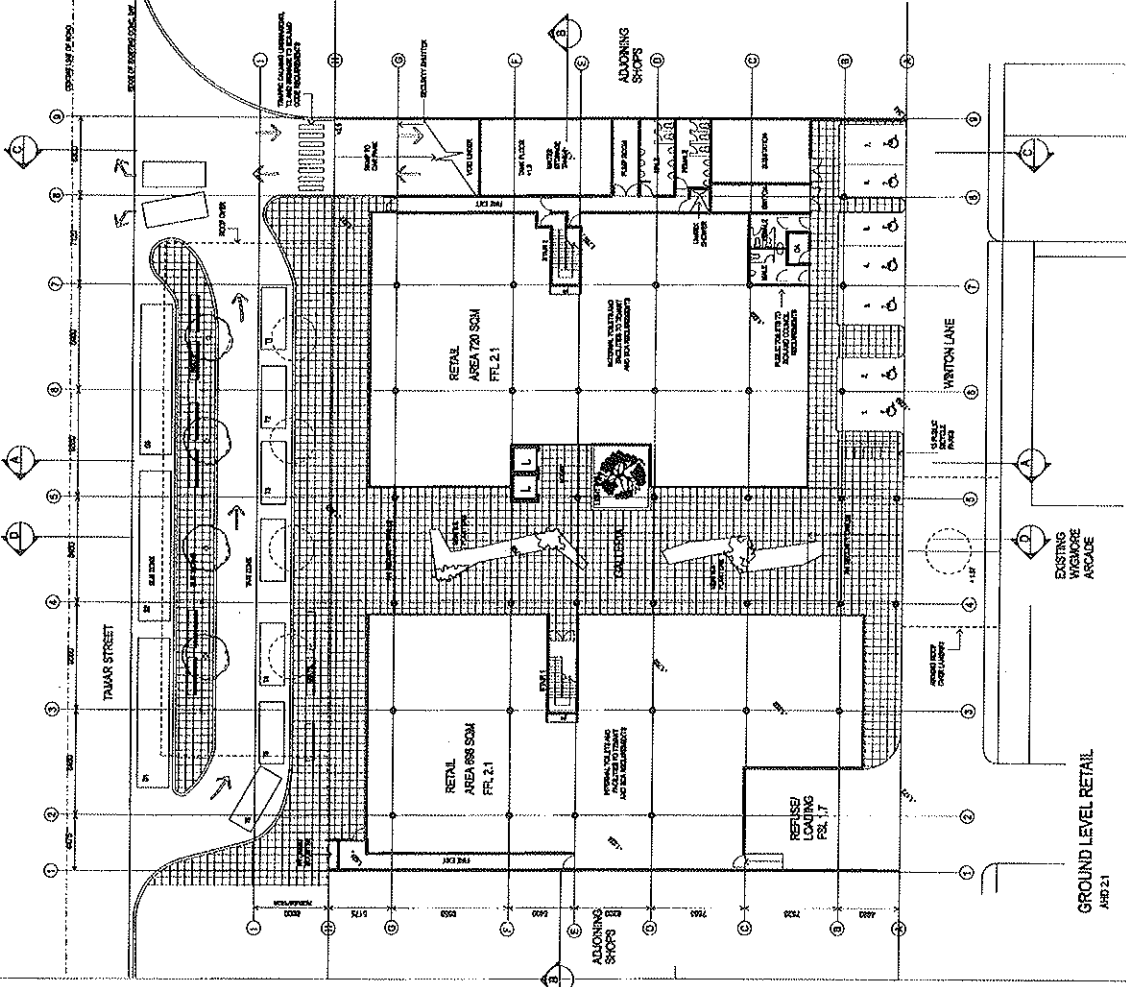
DATE DATE FOR DATE DATE FOR

DATE DATE FOR DATE DATE FOR

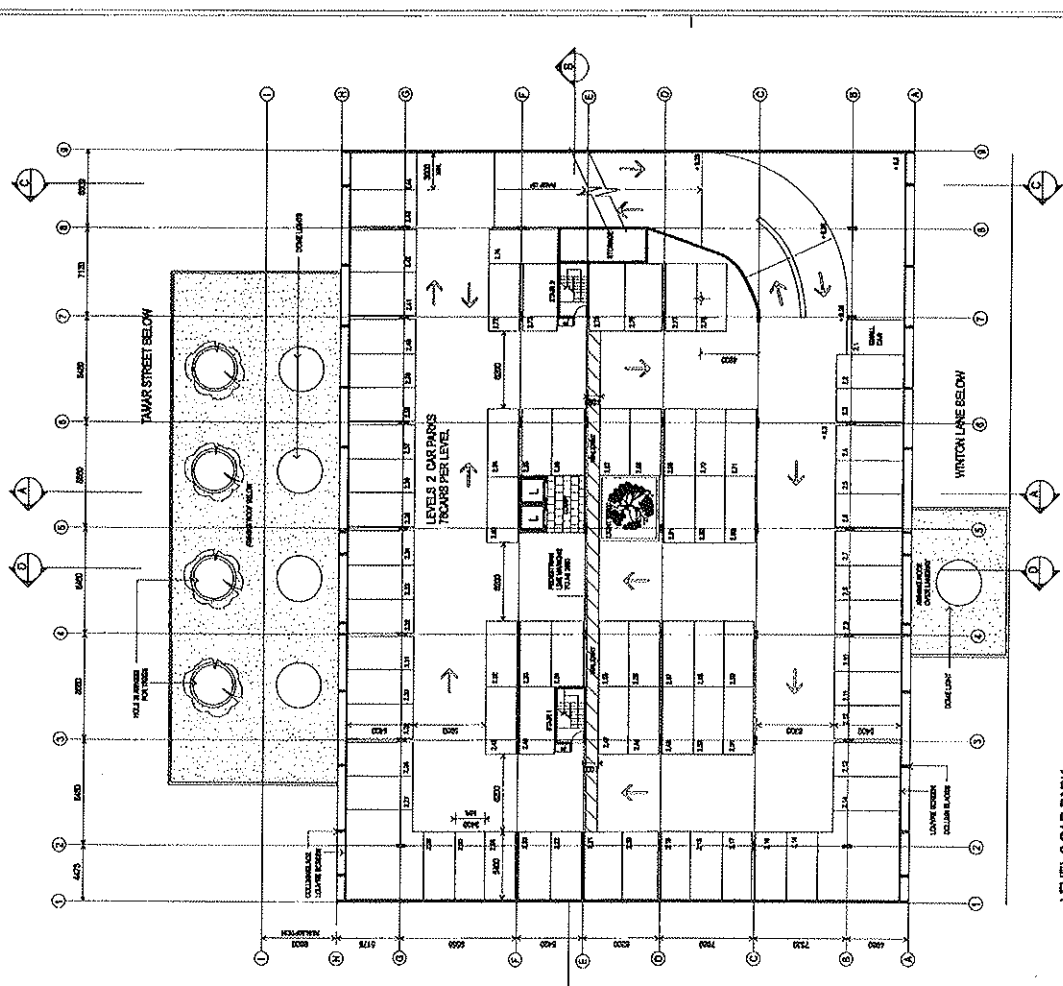
OWNER: JAMES & PATRICIA QUINN  
 PROJECT: QUINN COMMUNITY CENTER  
 ADDRESS: 1000 WINTON LANE, WINTON, MA 01890  
 ARCHITECT: BVM ARCHITECTS  
 ADDRESS: 1000 WINTON LANE, WINTON, MA 01890  
 DATE: 11/11/11

SECTION 1

DATE: 11/11/11  
 PROJECT: QUINN COMMUNITY CENTER  
 ARCHITECT: BVM ARCHITECTS  
 ADDRESS: 1000 WINTON LANE, WINTON, MA 01890  
 DATE: 11/11/11

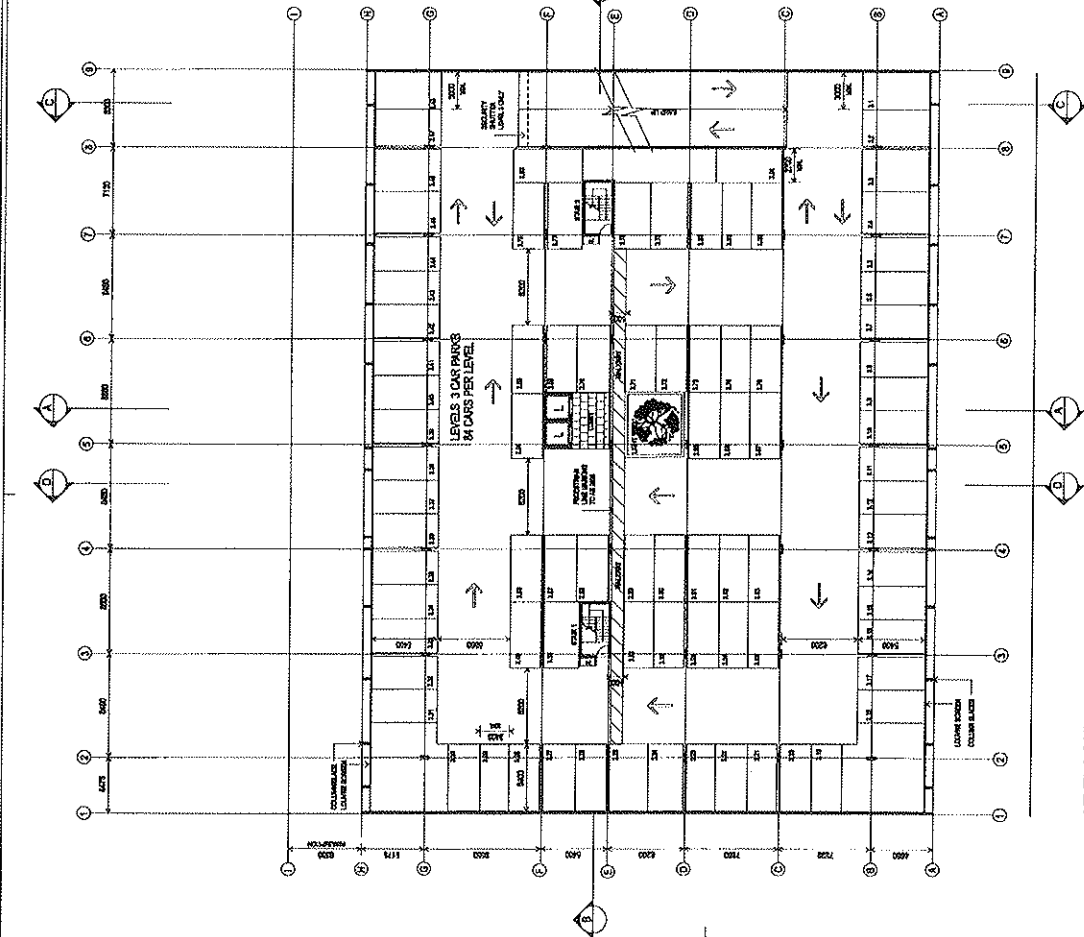


GROUND LEVEL RETAIL  
R1021

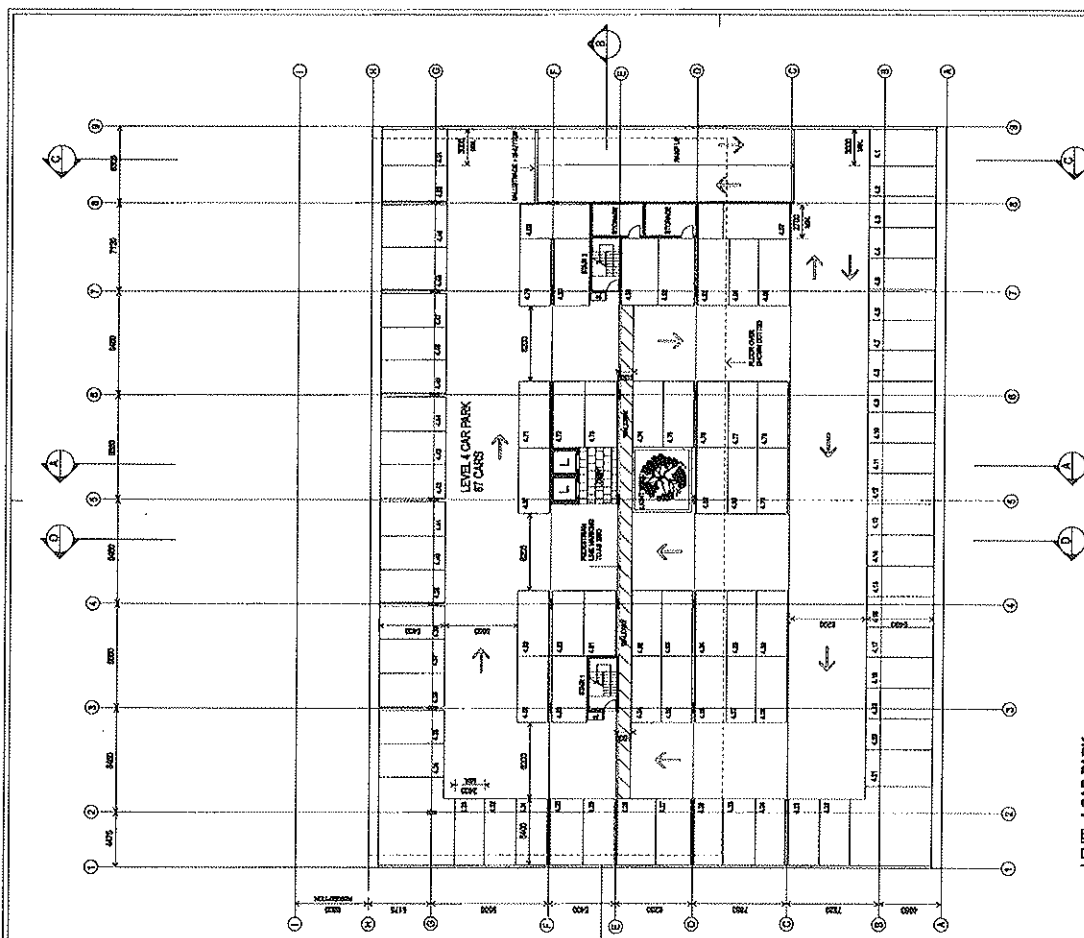


LEVEL 2 CAR PARK  
R1025

<p><b>ARCHITECT</b> BWA 1000-1000 1000-1000 1000-1000</p>		<p><b>ARCHITECTS ASSOCIATION</b></p>		<p><b>SCALE</b> OVERALL SIZE COLUMN SIZE SECTION</p>		<p><b>DATE</b> 2007</p>		<p><b>PROJECT</b> TURNER TOWNSHIP RAUHLINGS QUANTITY SURVEY (C/S) M OF 2004 1000 No. OF 2004 1000</p>		<p><b>CLIENT</b> TURNER TOWNSHIP RAUHLINGS QUANTITY SURVEY (C/S) M OF 2004 1000 No. OF 2004 1000</p>		<p><b>DATE</b> 13.11.2007</p>		<p><b>TABLE</b> B</p>	
<p><b>CONSULTANTS</b> STRUCTURAL &amp; CIVIL (M OF 2004 1000 No. OF 2004 1000) ELECTRICAL &amp; FIRE PROTECTION (M OF 2004 1000 No. OF 2004 1000) MECHANICAL &amp; PLUMBING (M OF 2004 1000 No. OF 2004 1000) LANDSCAPE ARCHITECTURE (M OF 2004 1000 No. OF 2004 1000)</p>		<p><b>SCALE</b> OVERALL SIZE COLUMN SIZE SECTION</p>		<p><b>DATE</b> 2007</p>		<p><b>PROJECT</b> TURNER TOWNSHIP RAUHLINGS QUANTITY SURVEY (C/S) M OF 2004 1000 No. OF 2004 1000</p>		<p><b>CLIENT</b> TURNER TOWNSHIP RAUHLINGS QUANTITY SURVEY (C/S) M OF 2004 1000 No. OF 2004 1000</p>		<p><b>DATE</b> 13.11.2007</p>		<p><b>TABLE</b> B</p>			



LEVEL 3 CAR PARK  
APP B4

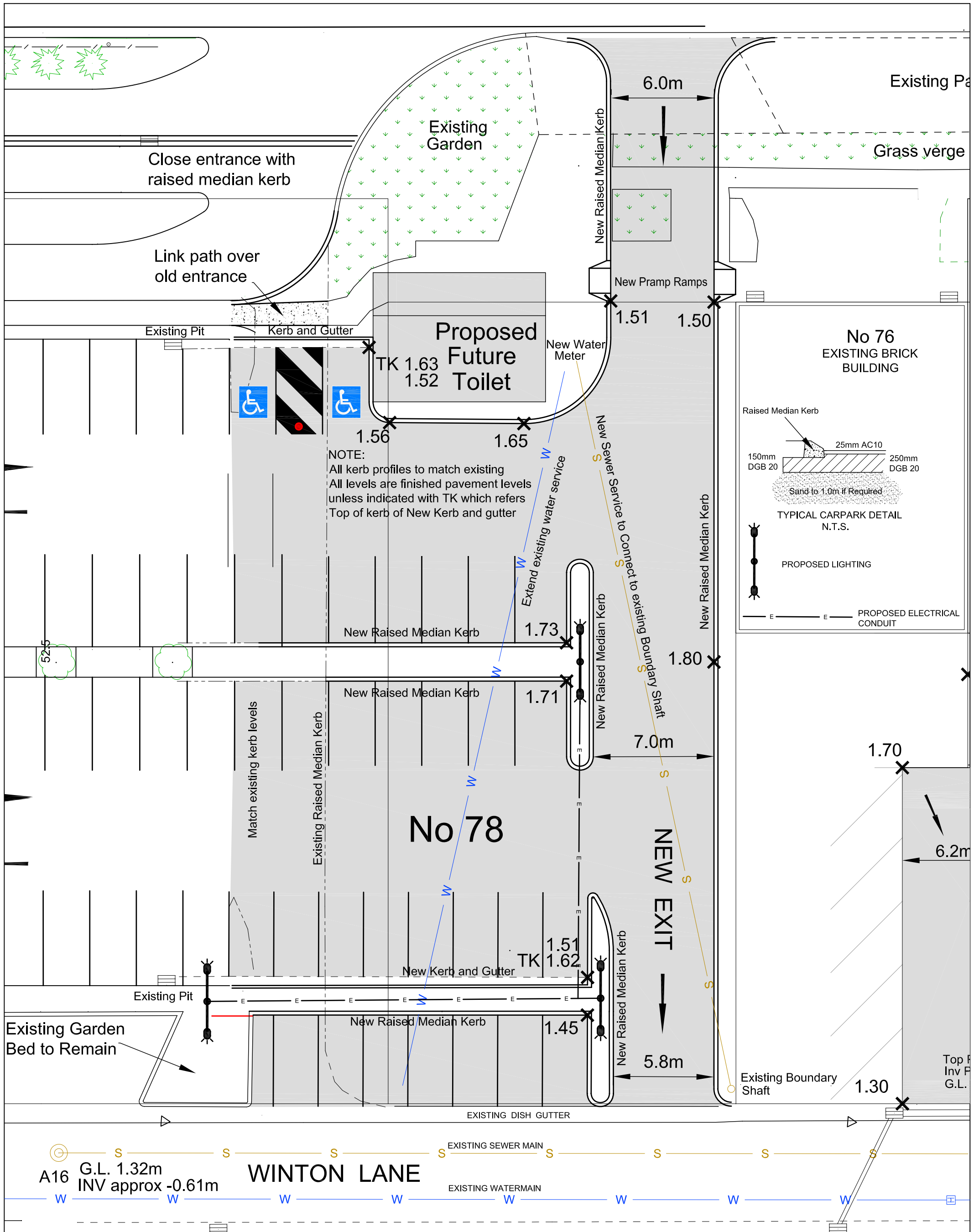


LEVEL 4 CAR PARK  
APP B5

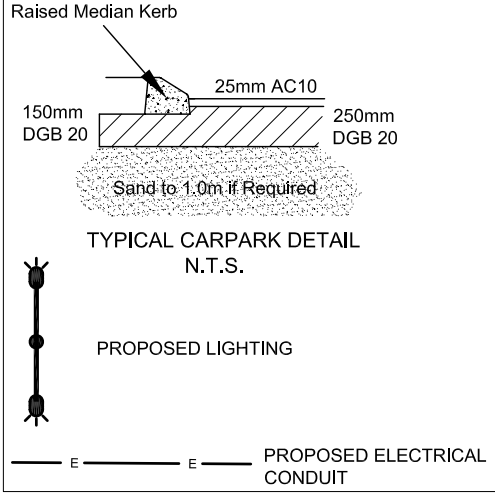
<b>ARCHITECTURE</b> ARCHITECTS IN ASSOCIATION 1111 W. 11th Street, Suite 100 Oklahoma City, Oklahoma 73106 Phone: (405) 241-1111 Fax: (405) 241-1112 www.aiaarchitects.com		<b>STRUCTURAL</b> ASHRAE REGISTERED PROFESSIONAL ENGINEER 1111 W. 11th Street, Suite 100 Oklahoma City, Oklahoma 73106 Phone: (405) 241-1111 Fax: (405) 241-1112 www.aiaarchitects.com		<b>ELECTRICAL</b> REGISTERED PROFESSIONAL ENGINEER 1111 W. 11th Street, Suite 100 Oklahoma City, Oklahoma 73106 Phone: (405) 241-1111 Fax: (405) 241-1112 www.aiaarchitects.com		<b>Mechanical</b> REGISTERED PROFESSIONAL ENGINEER 1111 W. 11th Street, Suite 100 Oklahoma City, Oklahoma 73106 Phone: (405) 241-1111 Fax: (405) 241-1112 www.aiaarchitects.com	
<b>CLIENT</b> TOWN OF OKLAHOMA 1111 W. 11th Street, Suite 100 Oklahoma City, Oklahoma 73106 Phone: (405) 241-1111 Fax: (405) 241-1112 www.aiaarchitects.com		<b>OWNER</b> TOWN OF OKLAHOMA 1111 W. 11th Street, Suite 100 Oklahoma City, Oklahoma 73106 Phone: (405) 241-1111 Fax: (405) 241-1112 www.aiaarchitects.com		<b>DESIGNER</b> TOWN OF OKLAHOMA 1111 W. 11th Street, Suite 100 Oklahoma City, Oklahoma 73106 Phone: (405) 241-1111 Fax: (405) 241-1112 www.aiaarchitects.com		<b>DATE</b> 11/11/2009	
<b>PROJECT</b> LEVEL 3 AND LEVEL 4 PLANS		<b>SCALE</b> 1/8" = 1'-0"		<b>DATE</b> 11/11/2009		<b>REVISION</b> 1. 11/11/2009	
<b>ARCHITECT</b> JAMES THOMPSON HARRIS QUANTITY SURVEYOR No. 07 8574, 1998 No. 07 8574, 1977		<b>ENGINEER</b> JEREMY FERRIER AMBROSE ARCH. LICENSED ARCHITECT No. 07 2005, 1919 No. 07 2005, 1919 No. 07 2004, 1972 No. 07 2004, 1972		<b>DESIGNER</b> JEREMY FERRIER AMBROSE ARCH. LICENSED ARCHITECT No. 07 2005, 1919 No. 07 2005, 1919 No. 07 2004, 1972 No. 07 2004, 1972		<b>DATE</b> 11/11/2009	
<b>OWNER</b> TOWN OF OKLAHOMA 1111 W. 11th Street, Suite 100 Oklahoma City, Oklahoma 73106 Phone: (405) 241-1111 Fax: (405) 241-1112 www.aiaarchitects.com		<b>DESIGNER</b> TOWN OF OKLAHOMA 1111 W. 11th Street, Suite 100 Oklahoma City, Oklahoma 73106 Phone: (405) 241-1111 Fax: (405) 241-1112 www.aiaarchitects.com		<b>DATE</b> 11/11/2009		<b>REVISION</b> 1. 11/11/2009	

## APPENDIX B



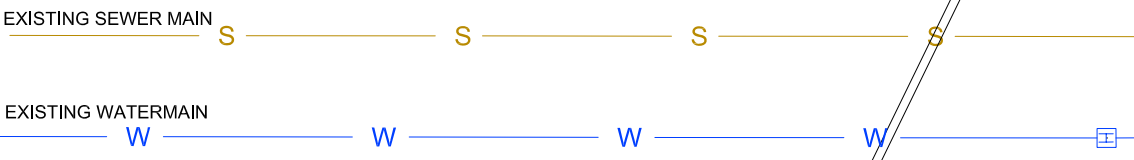


NOTE:  
 All kerb profiles to match existing  
 All levels are finished pavement levels  
 unless indicated with TK which refers  
 Top of kerb of New Kerb and gutter



A16 G.L. 1.32m  
 INV approx -0.61m

### WINTON LANE



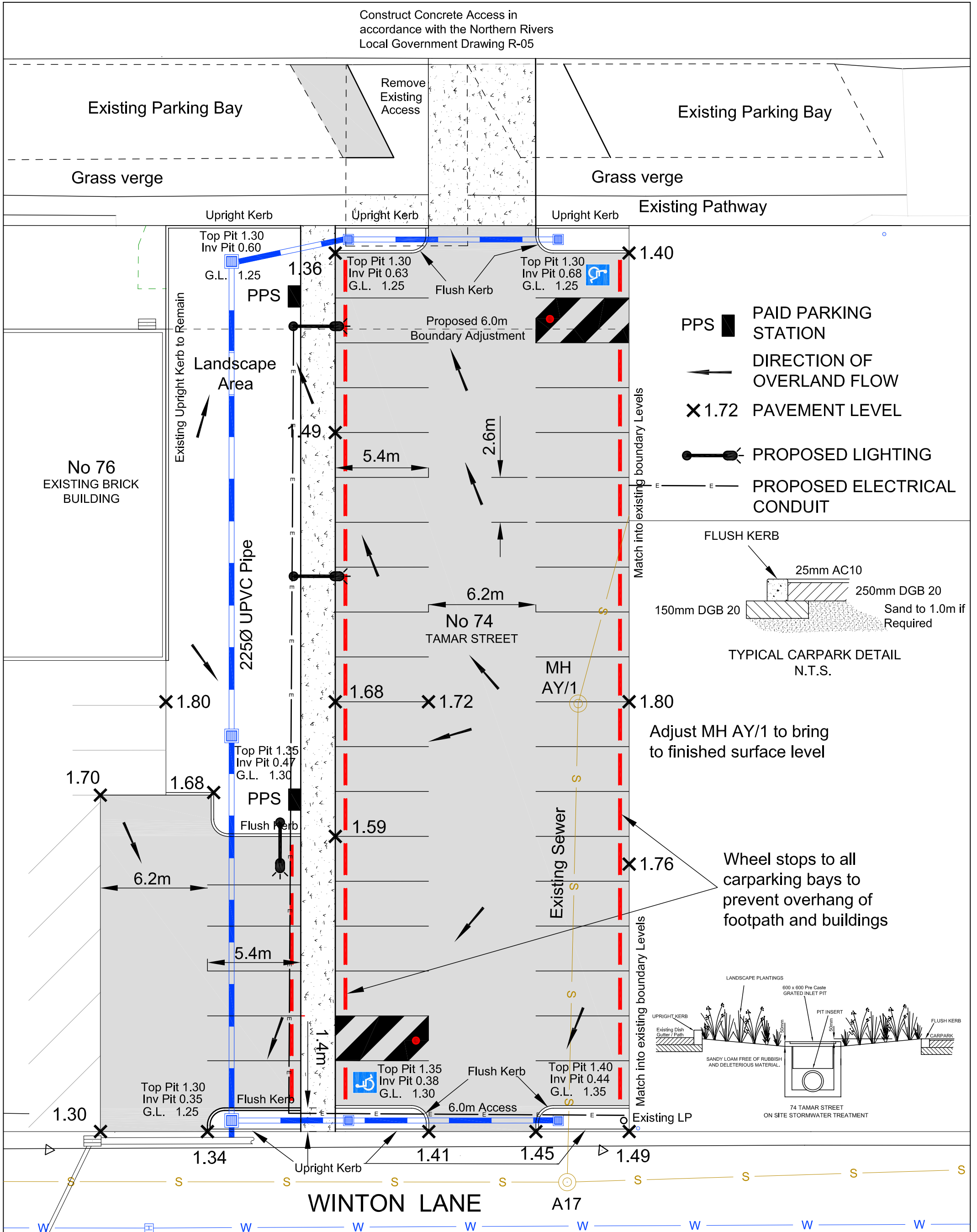
Notes: Setout information located in K:\Data\6\Tamar St Carpark No 74 and 78.ccx	SURVEY		DESIGNED	MNF	<b>BALLINA SHIRE COUNCIL</b>  78 TAMAR STREET PROPOSED CARPARK EXTENSION LAYOUT BALLINA	
	DATE		DECEMBER 2013	DRAWN		MNF
	F.B.	L.B.	CHECKED			
	DATUM	AHD	APPROVED			
DRAWING		Tamar Carparking Final Layout.dwg			Scale Hor 1 : 500 Vert 1 : 100	
No. Date By Change X'd Amendments		Sheet 1 Of 1 Sheets				Plan No. SR20_014_05 A1



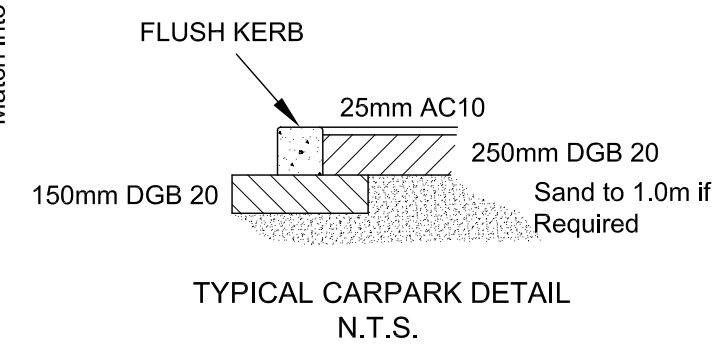
## APPENDIX C



Construct Concrete Access in accordance with the Northern Rivers Local Government Drawing R-05

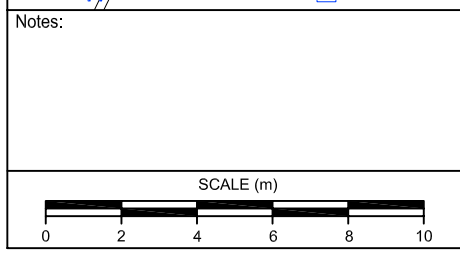
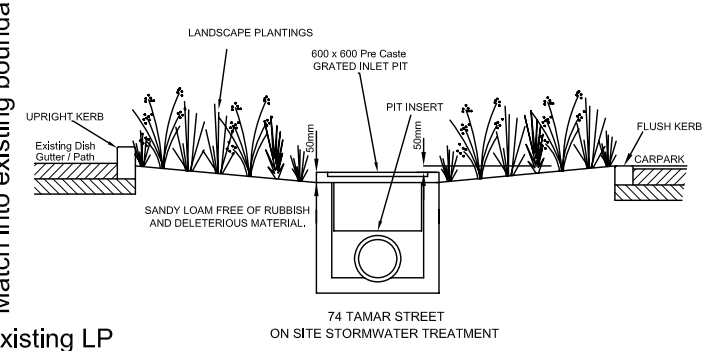


- PPS ■ PAID PARKING STATION
- ← DIRECTION OF OVERLAND FLOW
- × 1.72 PAVEMENT LEVEL
- PROPOSED LIGHTING
- E — PROPOSED ELECTRICAL CONDUIT



Adjust MH AY/1 to bring to finished surface level

Wheel stops to all carparking bays to prevent overhang of footpath and buildings



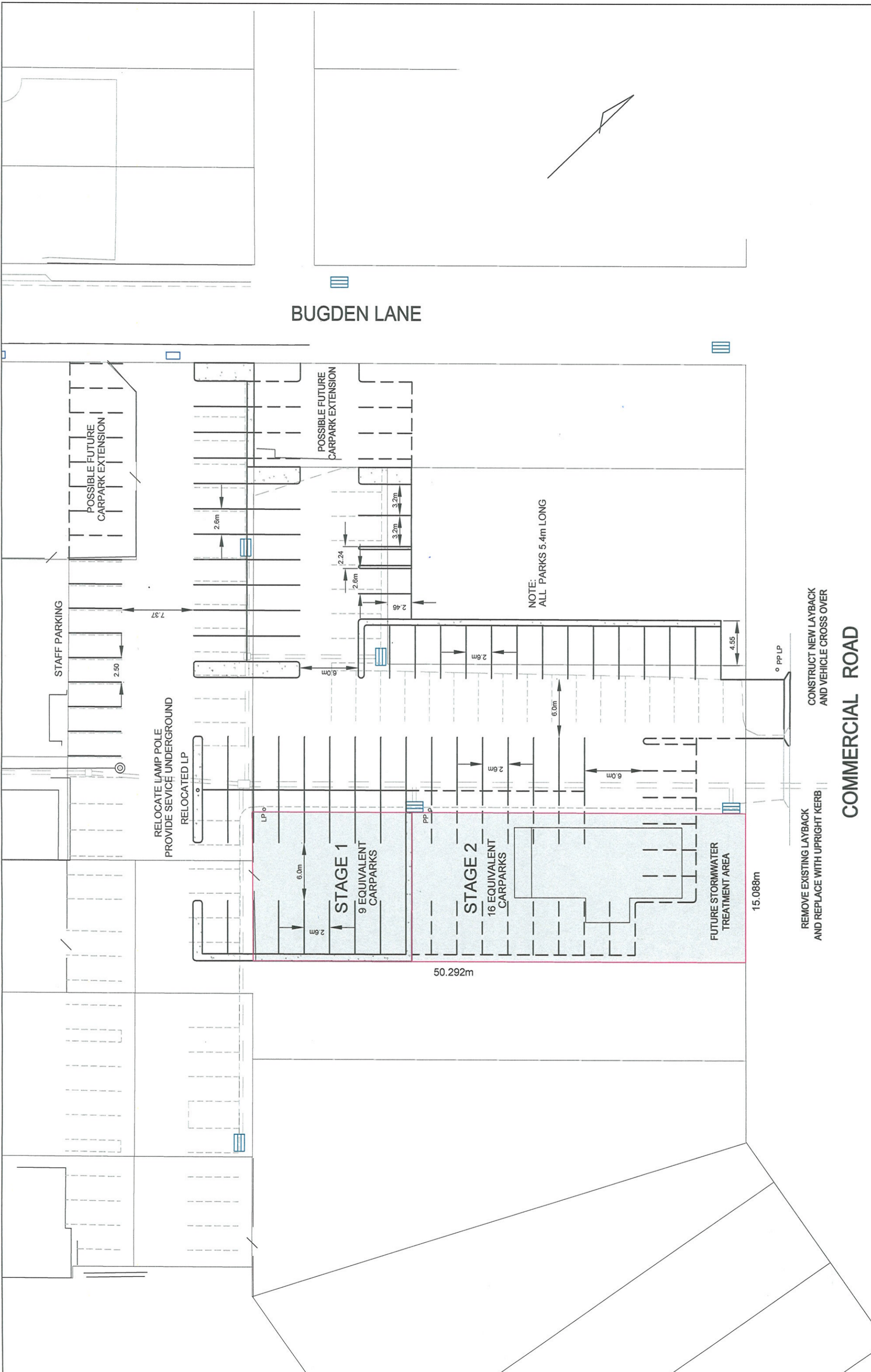
No.	Date	By	Change	X'd
Amendments				

SURVEY	DESIGNED	MNF
DATE SEPT 2013	DRAWN	MNF
F.B. L.B.	CHECKED	
DATUM AHD	APPROVED	
DRAWING Tamar Carparking Final Layout.dwg		
Sheet 1 Of 1 Sheets		

<b>BALLINA SHIRE COUNCIL</b>		
74 TAMAR STREET PROPOSED CARPARK LAYOUT BALLINA		
Scale	Hor 1 : 500 Vert 1 : 100	Plan No. SR20_014_04
		A1

## APPENDIX D





**BALLINA SHIRE COUNCIL**

ALSTONVILLE CBD CARPARK  
STAGING FOR EXPANSION OF  
COMMERCIAL ROAD CARPARK

SURVEY	DMK (XXXXXX)	DESIGNED	D. JONES
DATE	01/08	DRAWN	MNF
F.B.	L.B.	CHECKED	
DRAWING	ALSTONVILLE CARPARK	APPROVED	
DATUM	AHD	DATE	

Sheet	1	Of	1	Sheets
Scale	Hor 1 : 200			
Plan No.	SR40.019/1			

No.	Date	By	Change
			Amendments

Notes:

SCALE (m)